

Introduction to Sailing, 1-Day Class, 2023



**Sailing in Portland
Meetup Group**

**Introduction to
Sailing Class**



Introduction to Sailing

Introductions

- Me, Leslie, Matteo
- Leslie's House
- S/V June Bug
- S/V Ubiquity
- Other Boats

Introductions - YOU!

Some of you are new to sailing.

Some of you have lots of experience.

Some of you are boat owners, :-)) or :-(?

Poll to find Low-IQ people vs. High-IQ people in the room.

What We Will Do Today

- Cover some introduction to sailing material:
 - Can follow-up with another class session(s) if there is demand. Write a comment on-line if you want a follow-up.
- After the classroom work today:
 - Knot practice
 - Practice on boats: use winches, other
 - Sailing!

Your Follow-Up Resources:

- Sailing Terminology Page
- *Basic Keelboat* Book
- Introduction to Sailing Class Study Questions
- List of Basic Skills and Knowledge for Crewing on Sailboats

Singing and Sailing

- Who are Lin and Larry Pardey?
- **Another Time:** Listen to them sing their “Yacht Club Bar” song, from “Storm Tactics” DVD.
- Sing together the first verses of their “Yacht Club Bar” song.

Yacht Club Bar Song, Chorus

I love to sit around the yacht club bar
and talk about the things we're going to do.

I love to sit around the yacht club bar
because it doesn't move.

The swells are big and the winds are high
but that don't bother me.

Cause I never get lost and my tummy doesn't toss
It's a wonderful life on the sea.

Yacht Club Bar Song, Verse 1

My boat it is a big one boys. My crew it is the best.

We race around the entrance buoy beating all the rest.

We're the first ones home with a bent elbow and a powerful salt spray thirst.

We sit around and drink all night and see who comes in first.

Yacht Club Bar Song, Chorus

I love to sit around the yacht club bar
and talk about the things we're going to do.

I love to sit around the yacht club bar
because it doesn't move.

The swells are big and the winds are high
but that don't bother me.

Cause I never get lost and my tummy doesn't toss
It's a wonderful life on the sea.

Learning Goals

Fun, Challenge

Learn Basic Sailing Knowledge:

Terminology

Theory

Techniques

What to do on a sailboat

Result: You are more useful as crew, or a better captain, on a sailboat.

Why Sailing?

Why not do only power-boating instead?

“Life is too short for sailing” – a power-boating friend of mine.

How do power-boating and sailing differ?

Why do sailing?

What are the advantages and disadvantages of sailboats compared to powerboats?

Types of Sailboats

- How to differentiate different types?
- What could be different?
- Rigs: sloop, cutter, ketch, yawl, schooner, catboat, masthead sloops, fractional sloops
- Keels and rudders
- *Basic Keelboat*, pp. 80-81



The **cutter** is a sloop with its mast near the middle of the hull, allowing space to fly a second jib.



The **yawl** has two masts. Its mizzen (smaller) mast is behind the rudder post.



The **ketch** is another two masted boat. The mizzen (smaller) mast is in front of the rudder post.



The **schooner** has two or more masts, with the tallest usually in back.



The marconi-rigged **sloop** is the most common modern rig. It's excellent for sailing upwind.

Terminology: Parts of a Boat

- *Basic Keelboat*, pp. 6-7
- Basic parts of a boat
- Parts of the sailing equipment/rig (see next slide)
- Go to look at the boats, maybe after class ??

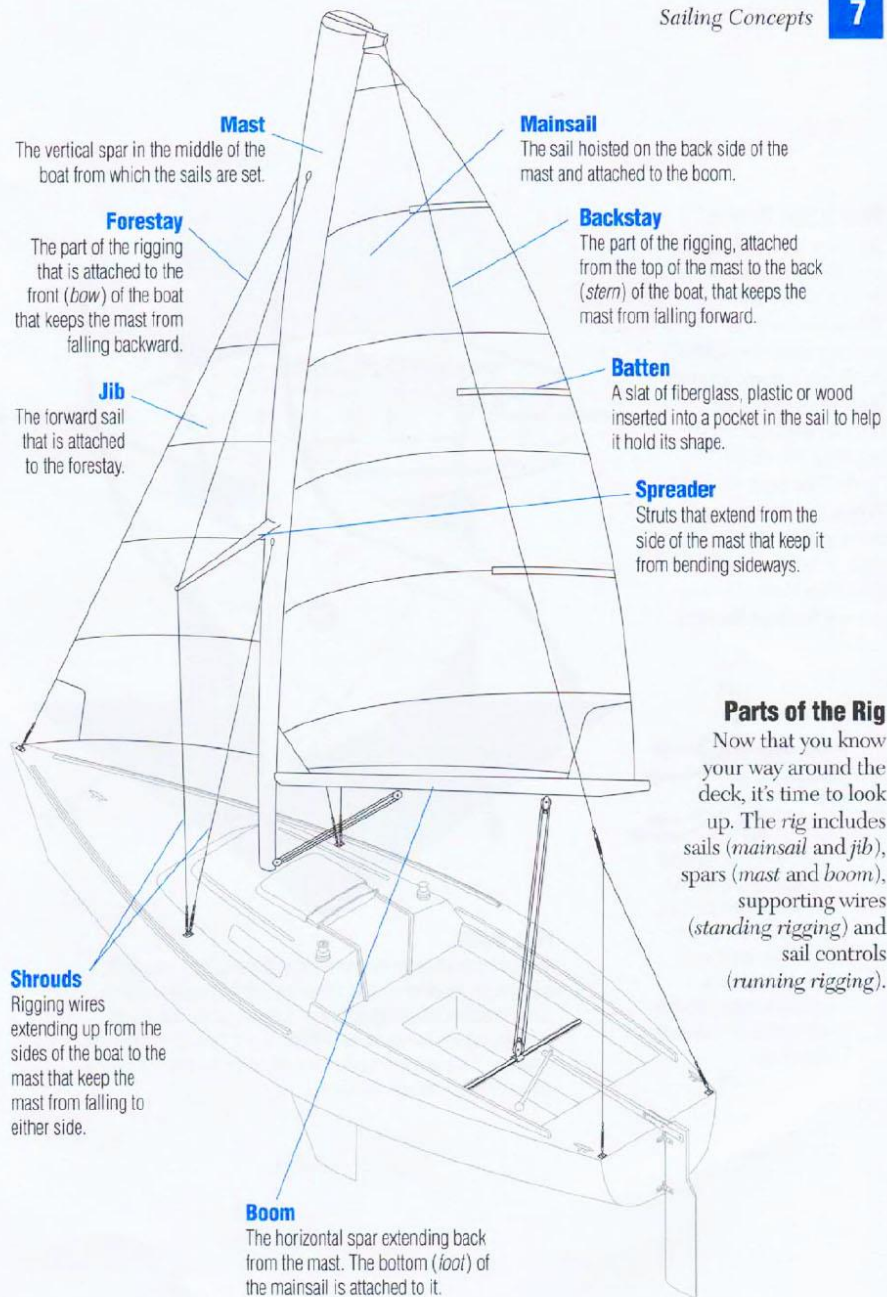

Parts of the Rig

Now that you know your way around the deck, it's time to look up. The *rig* includes sails (*mainsail* and *jib*), spars (*mast* and *boom*), supporting wires (*standing rigging*) and sail controls (*running rigging*).

Core Concept in Sailing

How the Boat is Oriented to the Wind

Implications:

Must keep track of wind direction.

We need terminology to describe boat's orientation to wind.

Orientation of boat to the wind determines how we adjust (trim) the sails.

Orientation to the Wind

Basic Keelboat, p. 15

Can we sail in all directions?

General Terms:

Beating

Reaching

Running

Points of Sail gives us more specific terms.

See *Basic Keelboat*, p. 15

Points of Sail

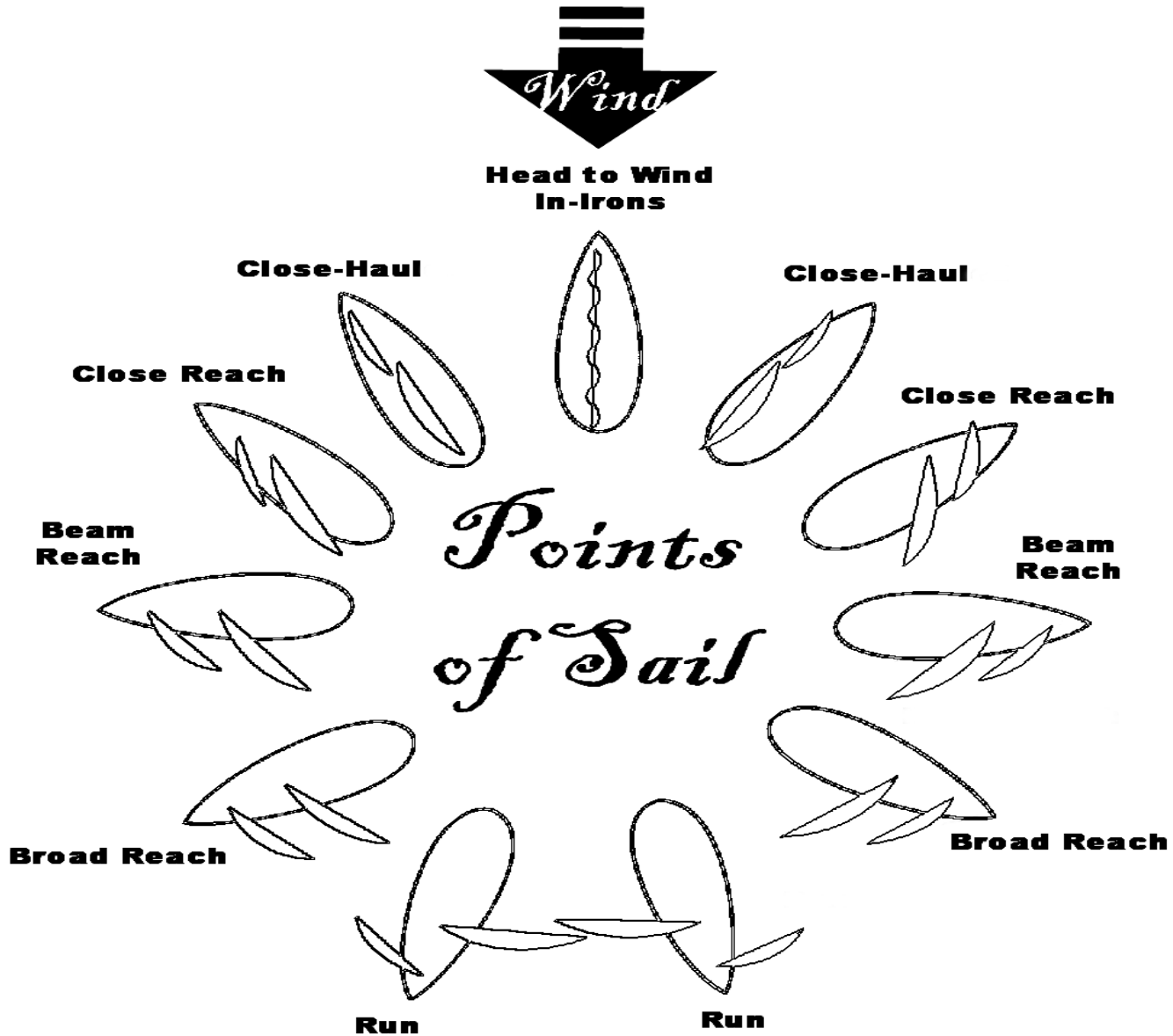

Terminology for Changing our Heading

Always relative to what we are focused on:
where the wind is coming from

“Head up”, “Heading up”, “Come up”,
“Bring it up”, etc.

“Head down”, “Heading down”, “Back
off”, “Fall off”, etc.

Basic Keelboat, pp. 16-17

Even the Sails Act Differently Depending on the Point of Sail

Bernoulli Effect

- Exercise with spoon under faucet demonstration

“Pull Mode” vs. “Push Mode”

- *Basic Keelboat*, pp. 8-9 (See next slide)

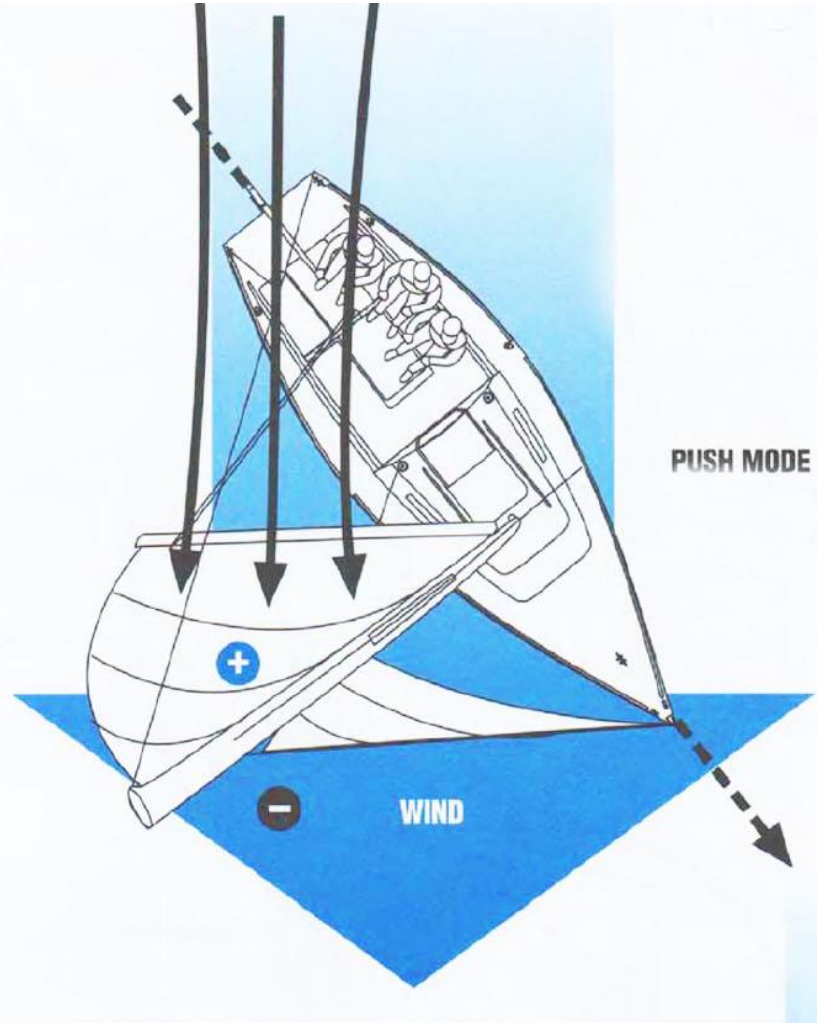
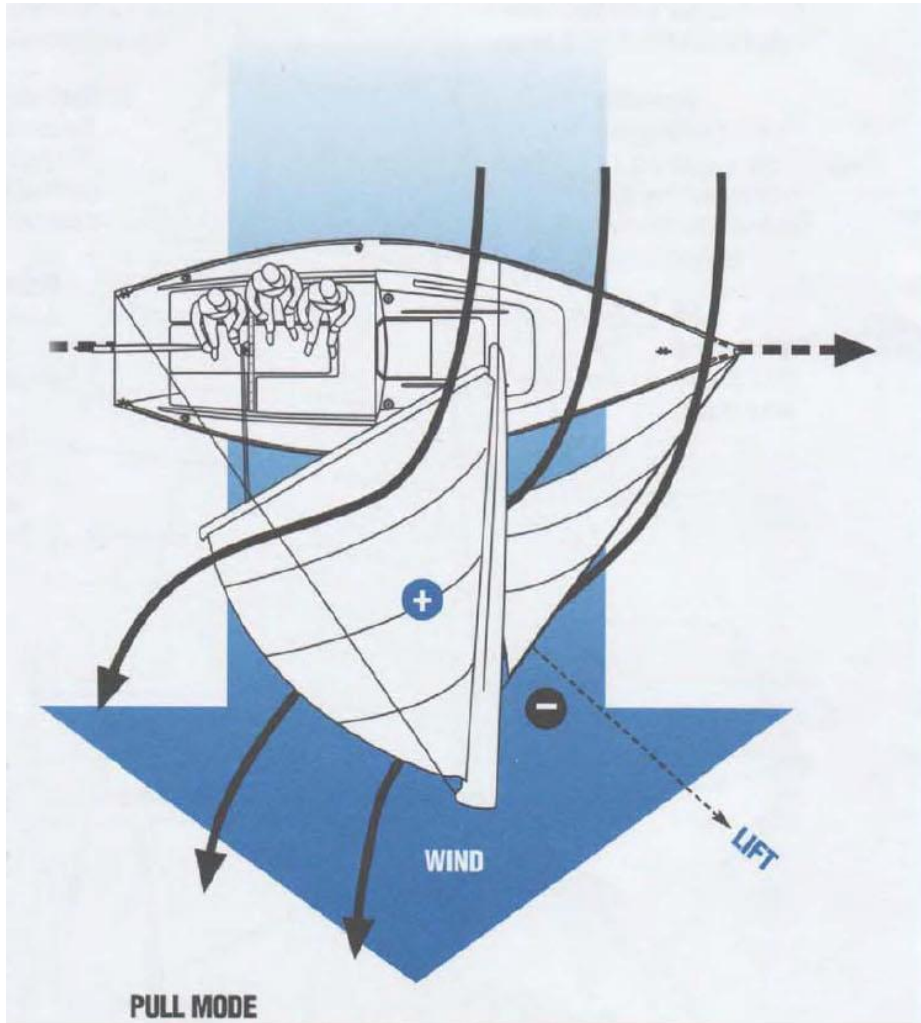

How far You Trim Out the Sails **Depends on the Point of Sail**

Basic Keelboat, pp. 10-14

How to trim for Different Points of Sail?

Effect of Trimming Sails Too Loose?

Effect of Trimming Sails Too Tight?

Telltails (*Basic Keelboat*, pp. 40-41)

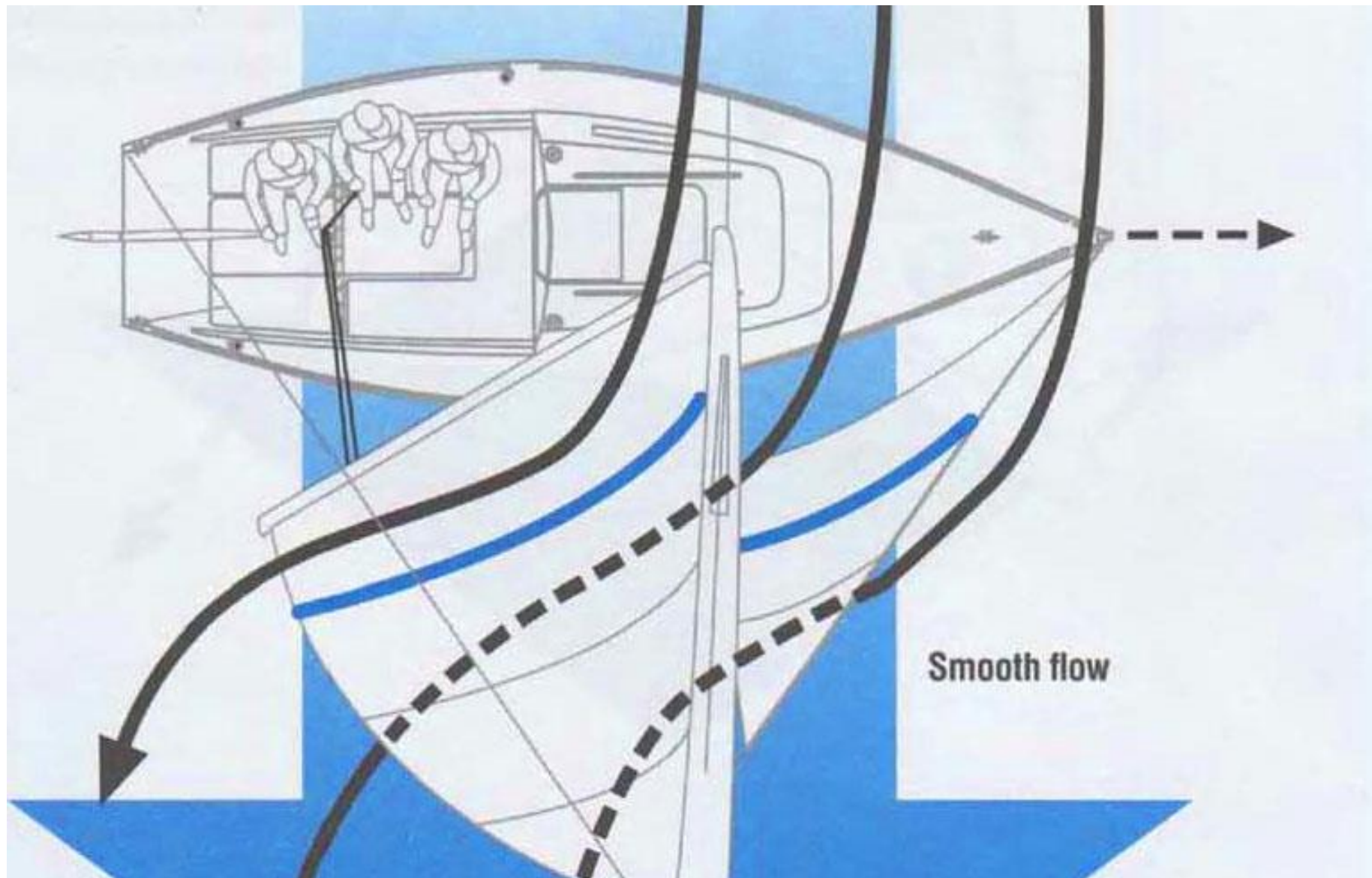



**Turbulent
(stalled)
flow**

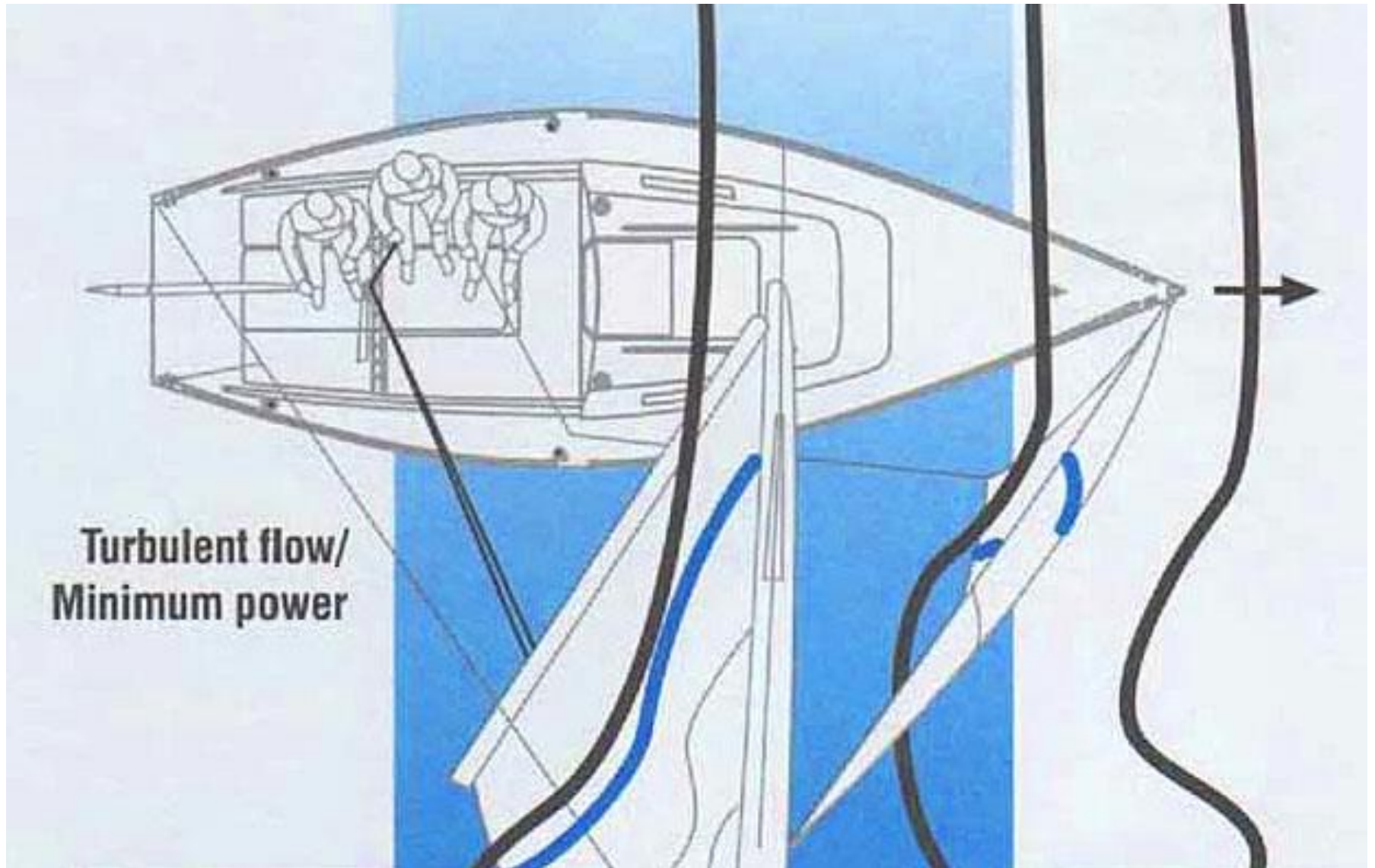

**Turbulent flow/
Minimum power**

Turning the Boat so that the Wind is on the Other Side

With wind in front:

Tacking, or Coming About

With wind in back:

Jibing

Tacking

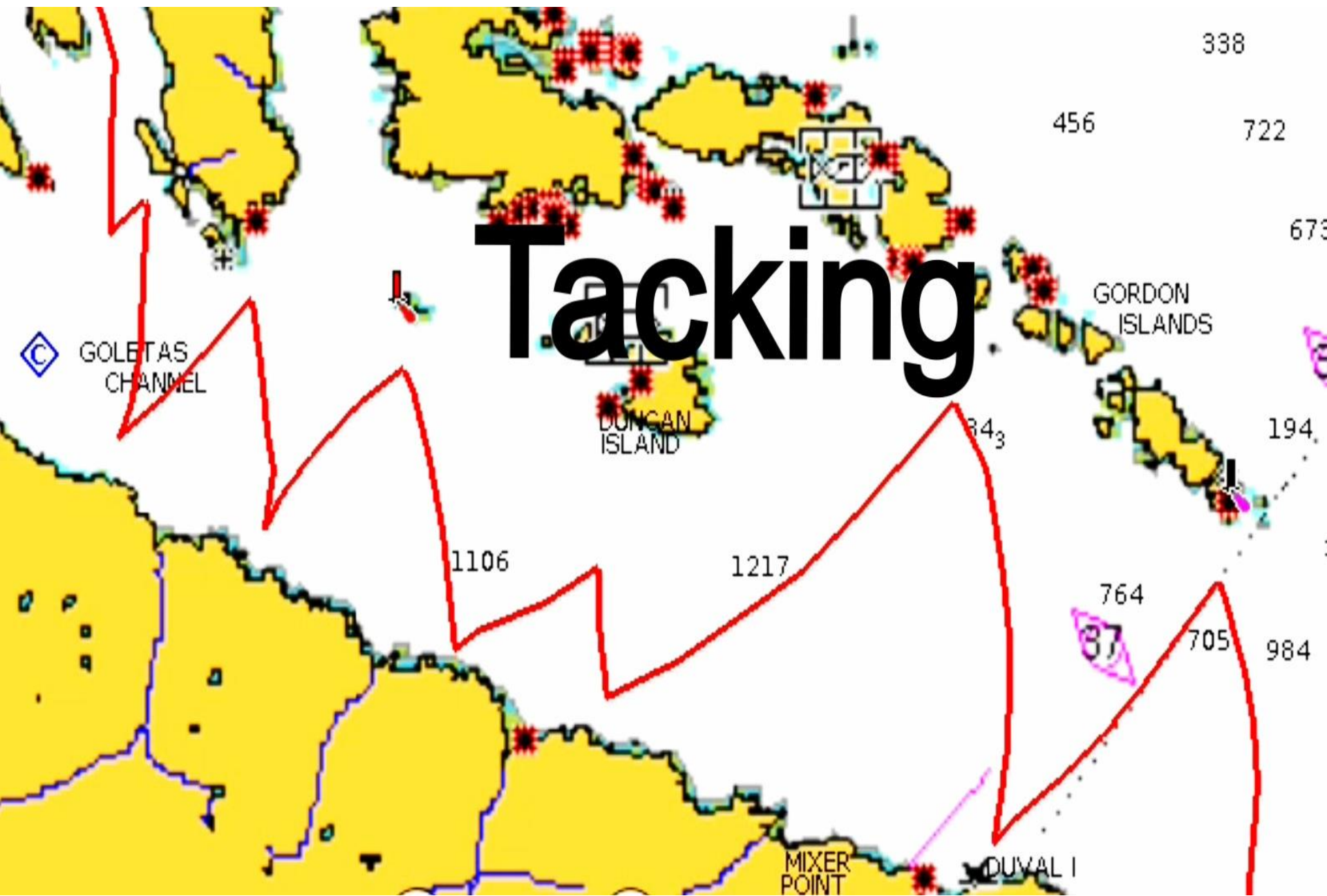

Tacking (Coming About)

Basic Keelboat, pp. 18-19

Commands:

Ready about? (or ready to tack?)

Ready!

Tacking (or hard alee, or helms alee)!

Jibing

Basic Keelboat, pp. 20-21

Commands:

Ready to jibe?

Ready!

Jibe ho!

Terminology: Sails and Major Control Lines

Most sails have:

3 corners, each with a name

3 sides, each with a name

Basic Keelboat, pp. 28-29

Halyards – To raise sails

Sheets – To trim sails

Inspect the boats to identify halyards, sheets

Crew Positions, Responsibilities

Basic Keelboat, p. 36

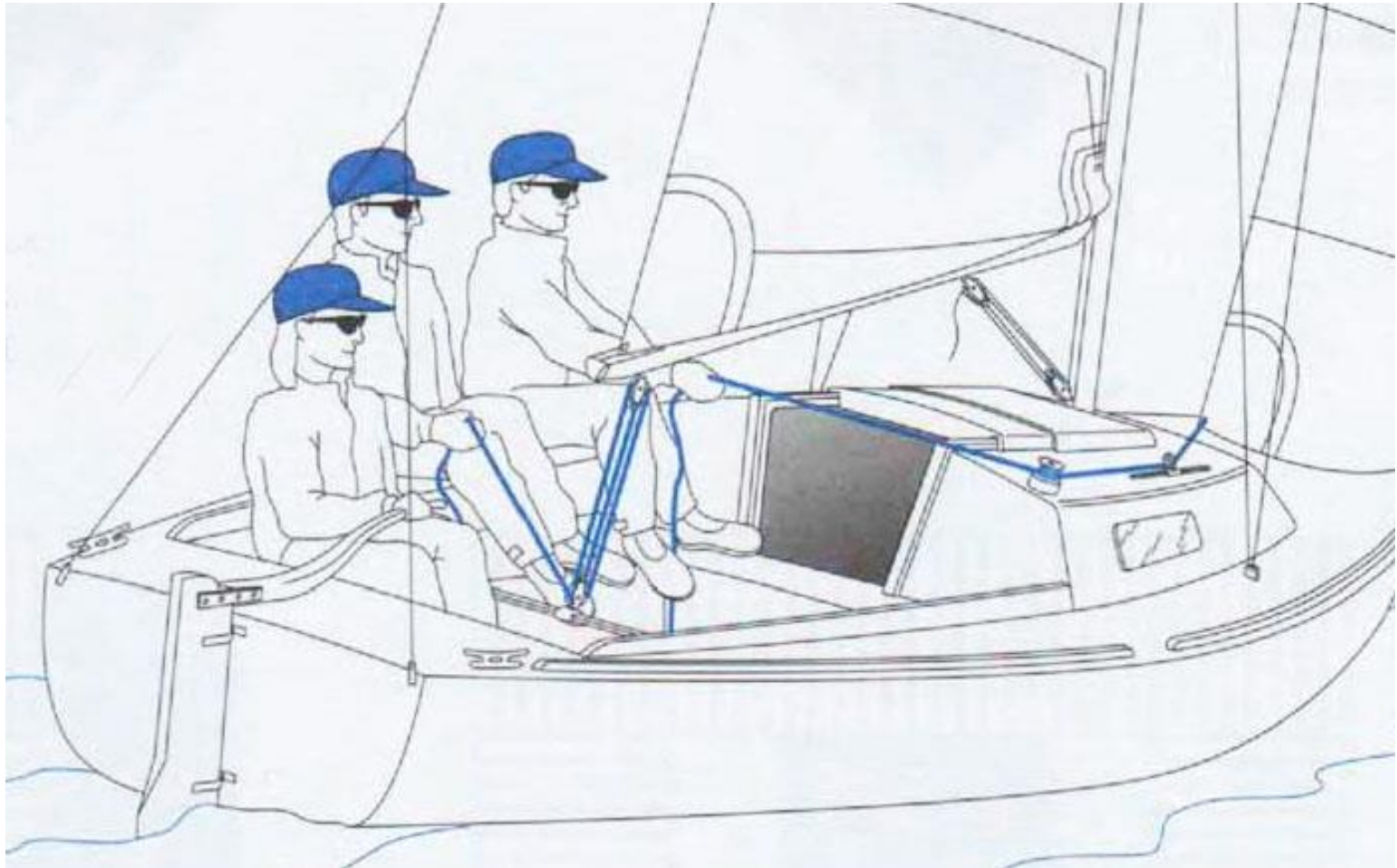

Helmsman Responsibilities

- Keep Watch
 - Boats, Barges, Deadheads, Buoys, Shallow Water
- Stay on Point of Sail
- Sailing Downwind: Guard vs. Inadvertent Jibe
- Responding to Wind Shifts (*Basic Keelboat*, pp. 54-55)
- Sometimes commands Tacks/Jibes

Tiller Steering

Basic Keelboat, p. 37

“Tiller Towards Trouble!”

Crew Responsibilities: **Tailing and Grinding**

- Self-Tailing Winches vs. Non-Self-Tailing Winches
- Use of Winch Handles
- Handling Working Sheet and Lazy Sheet
- Tying off Working Sheet

Other Crew Activities, Returning

Open life-line gate

Deploy fenders

Positioned to step quickly off onto dock

Tie Boat to the dock, *Basic Keelboat*, p. 49

Fold/bag headsail

Remove/coil jib sheets

Flake mainsail, stow lazy jacks

Stow main sheet

Position canvas, instrument covers

Tying/Un-Tying Boat to the Dock

Basic Keelboat, p. 49

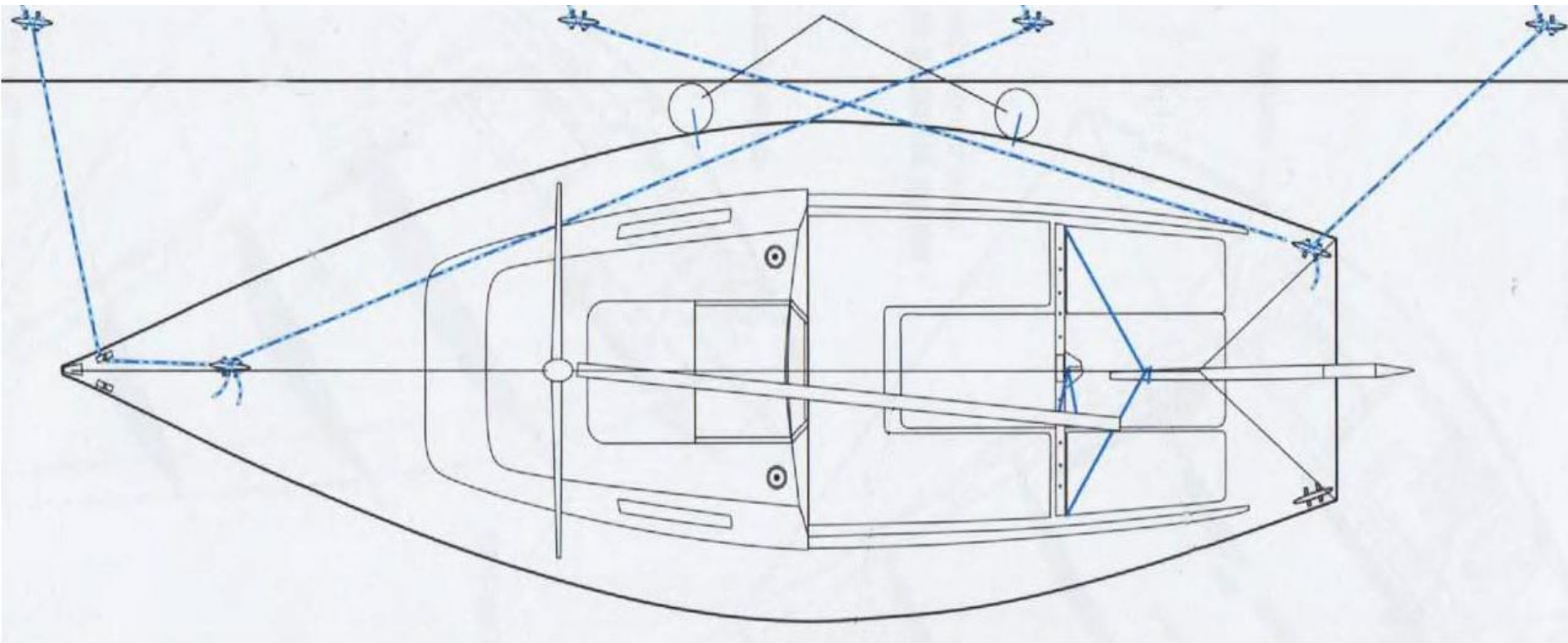

Sail Balance

Weather Helm versus Lee Helm

Balance

You can steer a boat with its sails instead of its rudder because of a principle called *balance*. A sailboat is a collection of forces in motion, not all of which are headed in the same direction. There are forces exerted by the mainsail and the jib, both of which pull the boat forward and sideways. There are opposing forces exerted by the water on the keel and rudder.

When all of these forces are *in balance*, the boat will sail forward in a straight line. If they are not, the boat will want to turn. This is why you are able to steer the boat by trimming in or easing either the mainsail or jib. By doing so, you are consciously throwing the boat *out of balance*.

As your sailing skills improve, you will use the principle of balance more and more to get the best performance out of your boat and execute more advanced maneuvers. For now, just understanding balance will help explain why certain things are happening on your boat.

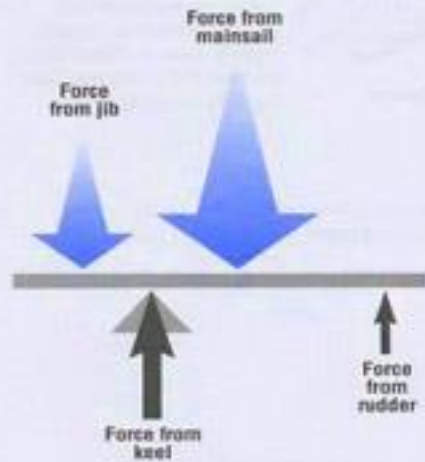

Forces on a sailboat act like weights on a see-saw (above), with the keel supporting the middle. If the force from one sail outweighs the other, the see-saw will tip (the boat will turn).

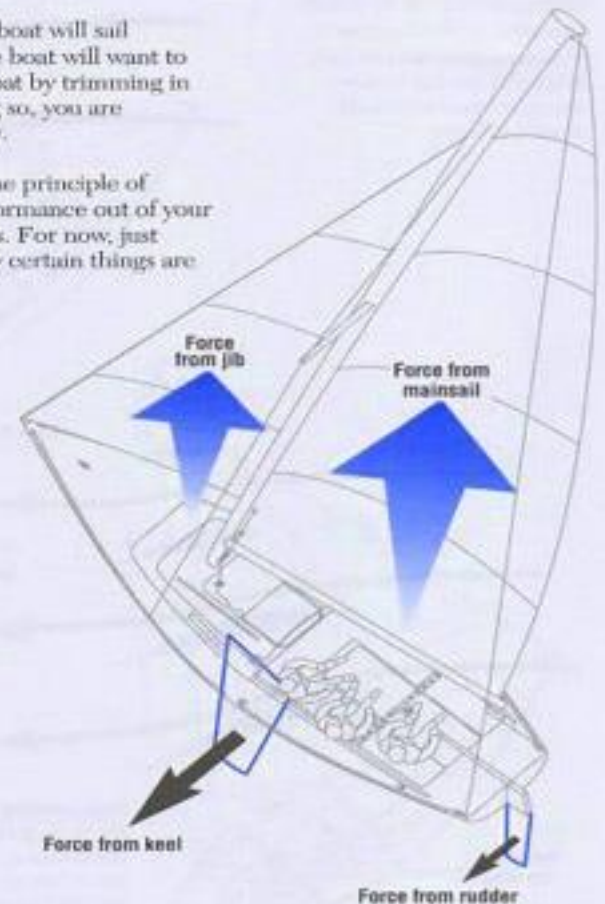

End of THINKING Part of Class

Switch to DOING Part of Class

On-Dock Practice:

- Winches
- Moving around on Boats

Working with Line:

- Coil a Line
- Knots

Sail on Boats

On-Dock Practice

Winches:

- Self-Tailing Winches
- 2-Speed Winches
- Using Winch Handles

Moving around on the Boats:

“One hand for you, one for the boat”

Working with Line

Learn to coil a line!

Bonus: Danish Coil, Braiding

Knots (*Basic Keelboat*, pp. 58-60):

- 1) Figure 8 Stopper Knot
- 2) Cleat Hitch
- 3) Round Turn and Two Half-Hitches
- 4) Bowline