

# **Development of a Phosphorus TMDL for Upper Klamath Lake, Oregon**

**prepared for**

**Oregon Department of Environmental Quality**

**2146 4th Street, Suite 104**

**Bend, Oregon 97701**

**By**

**William W. Walker, Jr., Ph.D., Environmental Engineer**

**1127 Lowell Road, Concord, Massachusetts 01742**

**Tel: 978-369-8061 Fax: 978-369-4230**

**<http://www.shore.net/~wwwalker>**

**[wwwalker@shore.net](mailto:wwwalker@shore.net)**

**March 7, 2001**

## Table of Contents

1.0	Introduction	1
2.0	Summary of TMDL Derivation	2
3.0	Water Quality Standards & Criteria	7
3.1	pH	7
3.2	Dissolved Oxygen	8
3.3	Free Ammonia	9
3.4	Algal Blooms	10
4.0	Data Sources & Summaries	11
5.0	Nutrient & Algal Dynamics	13
5.1	Phosphorus Cycling	13
5.2	Algal Dynamics	14
5.3	Seasonal Variations	14
5.4	Year-to-Year Variations	14
5.5	Biweekly Variations	15
5.6	Role of Nitrogen	20
6.0	Model Development	21
7.0	TMDL Simulations	25
8.0	Discussion	27
9.0	Conclusions	29
10.0	References	30

List of Tables

List of Figures

Appendix A - Spatial & Temporal Variations in Water Quality

## 1.0 Introduction

Upper Klamath Lake is a large (270 km<sup>2</sup>) and shallow (mean depth ~2 meters) hypereutrophic lake system located in south-central Oregon just east of the Cascades (Figure 1). It consists of two interconnected segments: Agency Lake (35.6 km<sup>2</sup>) and the main lake (235.4 km<sup>2</sup>). Algal productivity in both lakes is extremely high. Chlorophyll-a concentrations exceeding 200 ppb are frequently observed in the summer months (Kann & Smith, 1999). Blooms are accompanied or followed by excursions from Oregon's water quality standards for pH, dissolved oxygen, and free ammonia. These conditions threaten native fish populations, which include endangered species (shortnose sucker, Lost River sucker, and interior redband trout) (Perkins et al., 2000). Based upon monitored levels of dissolved oxygen, pH, and chlorophyll-a, both Agency and Klamath lakes have been designated as water quality limited for resident fish and aquatic life (ODEQ 303(d) List 1998).

The 9,758 km<sup>2</sup> watershed of Upper Klamath Lakes drains the eastern slope of the Cascades and its adjacent semi-arid plateau. Inflows consist of springs, snowmelt, seasonal runoff, and irrigation return flows. Developed areas around the lake include 126 km<sup>2</sup> of diked and drained former wetlands used seasonally for livestock grazing and row crops. Anthropogenic nutrient sources include agricultural uses (grazing, row crops), soil mineralization in adjacent diked and drained wetland areas, homesteads, roadways, and a fish hatchery. In Water Years 1992-1998, the total phosphorus load averaged 182 mtons/yr (metric tons per year), 70% of which was in soluble reactive form (Table 1, Kann & Walker, 2001). Particulate nutrient fractions indicative of watershed erosion are higher during periods of higher runoff. Assuming that phosphorus concentrations measured in flowing springs are representative of inflows under undeveloped conditions, approximately 40% (80% Confidence Interval = 33 to 47%) of the 1992-1998 phosphorus load has been attributed to anthropogenic sources (Kann & Walker, 2001).

This report describes the estimation of a phosphorus TMDL (Total Maximum Daily Load), required under the Clean Water Act (USEPA, 1999) to bring the lake system into

compliance with water quality standards. The TMDL is estimated using a dynamic mass-balance model that simulates phosphorus, chlorophyll-a, and pH variations as a function of external phosphorus loads and other controlling factors. The model is calibrated to extensive monitoring data collected in the Lake and its tributaries between 1990 and 1999. Results can be used by ODEQ in developing a phosphorus load allocation and implementation schedule, as required under the TMDL program (USEPA, 1999).

## **2.0 Summary of TMDL Derivation**

The entire lake system is viewed as a unit in developing the phosphorus target and TMDL. Although significant spatial variations in water quality may be observed on any given sampling date, spatial variations are generally small relative to seasonal and year-to-year variations. The hydrologic complexity of the system also precludes development of separate TMDL's for different regions of the Lake.

The TMDL is expressed as an average load to the entire system (Upper Klamath Lake & Agency Lake combined). This average load is referenced to Water Years 1992-1998 hydrologic conditions, the historical period of record used for calibrating the phosphorus mass-balance model. Average water and nutrient balances for this period developed by Kann & Walker (2001) are summarized in Table 1. The total phosphorus load averaged 182 mtons/yr and ranged from 112 to 241 mtons/yr. Approximately 5 mtons/yr is attributed to atmospheric deposition and the remainder, to watershed inflows. Given the nutrient storage and recycling processes in the Lake and its sediments, the long-term-average phosphorus load is more relevant than the daily, monthly, or yearly load as a factor controlling lake phosphorus concentrations, algal growth, and related water quality conditions.

Numerical water quality standards for pH, dissolved oxygen, and free ammonia are considered in developing the TMDL. The phosphorus target and loading regime are driven by the pH standard (<9.0), which was exceeded in 41% of historical (1990-1999) samples and in 89% of samples collected in July, the month with peak algal densities.

The pH standard controls the TMDL derivation; i.e., the phosphorus load required to achieve compliance with this standard is likely to be lower than that required to achieve compliance with other relevant water quality standards. Modeling of pH response is facilitated by strong correlations among growing-season phosphorus, chlorophyll-a, and pH measurements. Excursions from dissolved oxygen and ammonia standards occurred less frequently (13% and 2-8%, respectively, on an annual basis). Oxygen excursions occur most frequently (35%) in August, the period of declining algal blooms, when fish kills have also been observed (Perkins et al., 2000). While these variables are more difficult to model than pH, they are also causally linked to algal productivity and phosphorus levels. Future refinements to the TMDL can be made in the event that compliance with dissolved oxygen and ammonia standards is not achieved under a loading regime consistent with meeting the pH standard.

Although the mass-balance model simulates lake-mean phosphorus concentrations and the TMDL represents a long-term-average load to the entire system, the derivation considers seasonal and spatial variations in lake water quality. Seasonal variations are considered by simulating the entire calendar year and extracting compliance statistics for June & July, historically the period of peak algal growth and pH excursion frequency. Spatial variations (vertical & horizontal) are considered by modeling them as stochastic variations around the lake-mean value on a given sampling date. The approach therefore incorporates the "critical condition" concept required for consideration in TMDL development (USEPA, 1999).

Generally, "compliance" with water quality standards does not necessarily require that all measurements are below (or above) a specified numeric value at all locations and depths in every minute of every day of every year. Because water quality conditions and driving variables (e.g., season, climate, hydrology, biology) vary over a continuum, 100% compliance is theoretically unattainable under any loading regime. The quantitative definition of "compliance" should acknowledge the inherent spatial and temporal variability in the system, as well as uncertainties in the measurement process. The model developed below quantifies relationships between external phosphorus load and

pH excursion frequency. The selection of an appropriate compliance frequency (and corresponding TMDL) is left to the ODEQ.

An intermediate step in TMDL derivation is the estimation of an in-lake phosphorus target. The target is expressed as a maximum lake-mean concentration during June and July, the period of maximum algal growth rates and maximum pH excursion frequencies. It is computed from lake monitoring data as an area-weighted mean for the entire system (Agency mean  $\times$  0.13 + Klamath mean  $\times$  0.87, where 0.13 is the average ratio of Agency Lake area to the total area of both lakes). Empirical relationships developed from lake monitoring data indicate that a lake-mean phosphorus concentration of  $\sim$ 100 ppb corresponds to a mean chlorophyll-a concentration of  $\sim$ 66 ppb and a mean pH of 9.0 in June-July. Phosphorus target estimates are  $\sim$ 100 ppb to achieve compliance on a lake-mean basis (<50% of pH measurements  $>$  9.0 on any sampling date) and  $\sim$ 75 ppb to achieve 90% pH compliance (< 10% of pH measurements within the Lake exceed 9.0 on any sampling date). Figure 7 can be used to estimate June-July phosphorus targets for other assumed pH compliance rates.

The model used to estimate the TMDL considers effects of algal growth limitation by phosphorus, light, and temperature. Year-to-year variations in the timing and development of algal blooms during late spring and early summer are strongly temperature-dependent (i.e., summer blooms tend to be more intense in years when the lake warms up earlier in the season (Wood et al, 1996; Kann, 1998)). Seasonal maximum growth rates and pH levels are controlled primarily by phosphorus and secondarily by light and temperature.

TMDL estimates are based upon application of linked phosphorus-balance and lake-response models calibrated and tested using data from Water Years 1992 through 1998. Simulation results are expressed as relationships between percent reductions in historical watershed phosphorus loads (excluding atmospheric inputs of  $\sim$  5 mtons/yr) and pH excursion frequencies, computed using various spatial and temporal averaging methods. Results are plotted in Figure 24 and summarized below:

	Frequency of pH Values > 9.0				Lake-Mean pH		
Averaging :	Samples	Samples	Lake	Lake	Lake	Lake	Lake
Season :	Jan-Dec	June-July	Jan-Dec	June-July	June-July	Jan-Dec	Jan-Dec
Statistic :	Mean	Mean	Mean	Mean	Mean	Avg Yearly Maximum	1/7 Year Maximum
<b>Watershed Load Reduction (vs. 1992-1998 Load = 177 mtons/yr)</b>							
0%	26%	71%	29%	75%	<b>9.17</b>	<b>9.46</b>	<b>9.70</b>
25%	17%	42%	16%	28%	8.86	<b>9.19</b>	<b>9.50</b>
30%	16%	36%	15%	19%	8.78	9.04	<b>9.46</b>
35%*	9%	23%	5%	11%	8.70	8.91	<b>9.45</b>
40%*	5%	12%	4%	6%	8.60	8.79	<b>9.41</b>
45%*	1%	5%	0%	3%	8.51	8.67	<b>9.39</b>
50%	1%	3%	0%	0%	8.43	8.51	8.75
55%	0%	1%	0%	0%	8.35	8.43	8.56
* Equivalent to Background Loading Estimate, 33%-47% (Excludes Anthropogenic Sources)							

ODEQ's selection of a specific load reduction and corresponding TDML will depend upon the desired compliance rate. For example, if the objective were to limit the long-term-average percent of pH measurements exceeding 9.0 to less than 5% during June & July, a load reduction of ~45% would be required. If the objective were to limit the annual-average percent of lake-mean pH values exceeding 9.0 to less than 5%, a load reduction of 35% would be required. If the objective were to limit the maximum lake-mean pH over the 7-year record to less than 9.0, a load reduction of ~48% would be required. The TMDL selection could also consider the background loading estimate (no anthropogenic sources), which corresponds to a load reduction of ~40% (80% confidence interval = 33 to 47%).

Additional analysis would be required to evaluate pH responses under alternative reservoir regulation schedules. Simulation results indicate that under reduced loading regimes, year-to-year variations in peak algal densities and pH would be controlled primarily the magnitude and timing of the springtime phosphorus loading pulse. Because light limitation of algal growth would be less important under reduced loading regimes, year-to-year variations in water depth would have less impact on peak algal densities and pH, as compared with existing conditions.

Simulation results and observed data can be re-expressed as relatively simple relationships among average annual inflow phosphorus concentration, average lake phosphorus concentration in March-May, and pH excursion frequency in June-July (Figure 27). An average inflow concentration less than ~60 ppb (vs. historical range of 97 to 118 ppb) corresponds approximately to an average springtime lake phosphorus concentration of 30 ppb (vs. historical range of 39 – 81 ppb), and a summer pH excursion frequency less than 10%. Consideration should be given to expressing the TMDL as an average inflow concentration because it factors out much of the year-to-year hydrologic variability. Future monitoring programs should continue to track spring phosphorus levels.

There are indications of decreasing trends in both the average inflow concentration (-2.8 %/yr) and the average lake concentration (-8.2 %/yr) in Spring over the 1991-1998 period. While a portion of the apparent trend in the lake concentration may be attributed to changes in lake water-level management, the correlation between reductions in inflow and lake concentrations is evidence that control of external loads will be effective in reducing lake phosphorus levels and resulting algal blooms. Based upon the apparent trend in inflow concentration, it is estimated that approximately 8% of the required load reduction had already been achieved as of 1998 (relative to the 1992-1998 average). This may reflect watershed management activities, including public purchase of major tracks of diked and drained areas adjacent to the Lake that were formerly used for grazing.

This analysis provides a starting point for an iterative TMDL process. Additional analysis would be required to estimate the uncertainty associated with model parameter estimates and predictions. Future refinements to the model structure and/or calibration could be developed based upon future monitoring data from the watershed and Lake and reflect any observed responses to implementation of phosphorus load controls under the TMDL program.



### 3.0 Water Quality Standards & Criteria

This section describes water quality standards and criteria that are used as a basis for developing the lake phosphorus target and TMDL. Consideration is given to dissolved pH, dissolved oxygen, un-ionized ammonia, and algal bloom frequency (as measured by chlorophyll-a concentration). Historical excursion frequencies and causal linkages to algal productivity and phosphorus loads are discussed.

#### 3.1 pH

pH standards for protection of redband trout in Upper Klamath Lake under Oregon Administrative Rule OAR 340-041-0965 are stated below:

*pH values shall not fall outside the ranges identified in paragraphs (A) and (B [not applicable to Klamath]) of this subsection. The following exception applies: Waters impounded by dams existing on January 1, 1996, which have pHs that exceed the criteria shall not be considered in violation of the standard if the Department determines that the exceedance would not occur without the impoundment and that all practicable measures have been taken to bring the pH in the impounded waters into compliance with the criteria:*

*(A) Fresh waters except Cascade lakes: pH values shall not fall outside the range of 6.5 to 9.0. When greater than 25 percent of ambient measurements taken between June and September are greater than pH 8.7, and as resources are available according to priorities set by the Department, the Department shall determine whether the values higher than 8.7 are anthropogenic or natural in origin;*

It is beyond the project scope to evaluate impacts of the lake's operation as an impoundment on pH levels, to determine whether all practicable control measures have

been applied, or to determine the exact origin of all phosphorus loads. It is assumed that these issues will be addressed, as appropriate, in future steps of the TMDL process.

On an annual-average basis, pH levels of 9.0, 9.5, and 10.0 were exceeded in 41%, 17%, and 3% of the 1990-1999 samples, respectively. The 9.0 pH standard was exceeded in 89% of the samples collected during July, the month with the highest average excursion rate. While not mentioned explicitly in the standards, a pH of 9.5 (exceeded in 45% of the July samples) has been suggested as a criterion for protecting lake sucker populations (Wood et al, 1996; Kann & Smith, 1999). Aside from toxicity considerations, elevated pH levels are of concern because they trigger phosphorus releases from lake bottom sediments and contribute to higher free ammonia levels (Kann, 1998; Walker, 1995; Perkins et al, 2000).

Correlations between pH and concentrations of chlorophyll-a (Kann & Smith, 1999) and phosphorus (see below) are consistent with the hypothesis that pH excursions are triggered by photosynthetic removal of carbon dioxide. The analysis below indicates that algal biomass is limited primarily by phosphorus during June & July, months with the highest pH excursion rates. Accordingly, reductions in phosphorus loads would be expected to provide reductions in pH excursion rates. Empirical modeling of pH response is facilitated by relatively strong correlations among pH, chlorophyll-a, and phosphorus concentrations.

### 3.2 Dissolved Oxygen

Dissolved oxygen standards for protection of redband trout in Upper Klamath Lake under Oregon Administrative Rule OAR 340-041-0965 are stated below:

*"For waterbodies identified by the Department as providing cold-water aquatic life, the dissolved oxygen shall not be less than 8.0 mg/l as an absolute minimum. Where conditions of barometric pressure, altitude, and temperature preclude attainment of the 8.0 mg/l, dissolved oxygen shall*

*not be less than 90 percent of saturation. At the discretion of the Department, when the Department determines that adequate information exists, the dissolved oxygen shall not fall below 8.0 mg/l as a 30-day mean minimum, 6.5 mg/l as a seven-day minimum mean, and shall not fall below 6.0 mg/l as an absolute minimum"*

The applicability & attainability of the 8 ppm standard are broader issues to be addressed in future steps of the TMDL process. The biweekly database does not permit direct quantification of the "30-day mean minimum" or "7-day minimum mean" dissolved oxygen levels. The database does permit evaluation of compliance with the 6 ppm "absolute minimum" standard. On an average annual basis, oxygen levels were below 4, 6, and 8 ppm in 5%, 13%, and 34% of the 1990-1999 samples, respectively. Excursion frequencies were 16%, 35%, and 65%, respectively, during August, the period of declining algal blooms. Oxygen excursions are likely to be related to decomposition of algal detritus and algal respiration, particularly during and following bloom die-off events. Accordingly, reductions in phosphorus loads would be expected to provide reductions in algal biomass levels and oxygen excursion rates. The strong correlation between dieoff of algal blooms (as reflected by decrease in chlorophyll-a) and minimum dissolved oxygen levels in July-August is consistent with this hypothesis (Perkins et al., 2000).

### 3.3 Free Ammonia

Wood et al. (1996) report that levels of un-ionized ammonia exceeded chronic toxicity criteria for salmonids at frequencies of 8% in 1990 to 2% in 1992 & 1994 (excluding samples with pH exceeding 9). Perkins et al. (2000) reported free ammonia levels in the range of 200-2000 ppb at three stations in parts of July, August, & September, 1995-1997. Free ammonia levels are strongly dependent upon pH and total ammonia concentrations, a portion of which is derived from decomposition of algal detritus (Bowie et al, 1985; Wood et al, 1996). Accordingly, reductions in phosphorus loads would be expected to provide reductions in ammonia excursion rates.

### 3.4 Algal Blooms

The pH, oxygen, and free-ammonia excursions can be traced directly or indirectly to excessive algal growth. Elevated pH levels in Upper Klamath Lake are strongly correlated with chlorophyll-a concentrations (Kann & Smith, 1999). Respiration and decay of algal biomass contribute to depressed dissolved oxygen levels following die-off of algal blooms (Perkins et al., 2000). Relationships between oxygen depletion rates and algal productivity have been demonstrated in stratified lakes (Mortimer 1942; Walker, 1979). Given causal mechanisms linking algal blooms to exceedance of water quality standards, bloom frequencies are also quantified and correlated with lake phosphorus concentrations.

Algal bloom frequencies are computed using criteria of 50, 100, and 200 ppb chlorophyll-a. These criteria were exceeded in 48%, 30%, and 13% of 1990-1999 samples, respectively, and in 90%, 64%, and 30% of the samples in July, the month with the highest average chlorophyll-a levels. These criteria are generally higher than the 20–60 ppb levels typically considered to reflect “nuisance” blooms that impair water quality and beneficial uses (Walker 1985b; Walker & Havens, 1995). The analysis indicates that the 50-200 ppb range in chlorophyll-a corresponds approximately to an 8.8-9.7 range in pH during the critical June-July period.

The biweekly database is the primary frame of reference for evaluating compliance with water quality standards and deriving lake phosphorus target. As a consequence of diurnal variations induced by solar radiation, air temperature, wind, and photosynthetic activity, actual excursion frequencies for pH and dissolved oxygen may differ from those estimated from daytime grab samples. Given tendencies for oxygen and pH levels to be lowest at dawn, daytime grab samples may underestimate the 24-hour excursion frequency for dissolved oxygen (< 6 ppm) and overestimate the 24-hour excursion frequency for pH (> 9), depending upon the actual time of sample collection. Because of data constraints, it is not practical at this point to factor diurnal variations directly into the

TMDL derivation. Since the standard in each case refers to an "absolute minimum", a precise estimate of the 24-hour mean is not needed to identify an excursion. If necessary, diurnal variations can be factored into future refinements of TMDL.

The pH standard (<9.0) controls the TMDL derivation. Modeling of pH excursions is facilitated by relatively strong correlations with lake phosphorus and chlorophyll-a concentrations. Given the relative magnitudes of the historical excursion rates, the phosphorus load required to achieve compliance with the pH standard is assumed to be lower than that required to achieve compliance with the other standards. Causal linkages with algal productivity suggest that substantial reductions in excursion rates for dissolved oxygen and un-ionized ammonia would be expected if phosphorus loads were reduced sufficiently to achieve compliance with the pH standard. Load allocations can be revised in the future in the event that compliance with all relevant standards is not achieved after implementing the TMDL driven by the pH standard.

#### **4.0 Data Sources & Summaries**

Data resources include extensive lake and watershed monitoring data collected in the 1990's by the Klamath Tribes, U.S. Department of the Interior, and the U.S. Geological Survey (Campbell, 1993; Snyder & Morace, 1997; Kann & Walker, 2001; Kann, 1998; Kann, 1999). Mass balance models are developed using biweekly water and nutrient balances compiled by Kann & Walker (2001) for the April 1991 - September 1998 period, as summarized in Table 1.

Lake water-quality conditions are evaluated using ~biweekly samples collected at 14 stations between 1990 and 1999 (Kann, 1998;1999). Station locations are shown in Figure 2. Eleven of the stations were sampled more or less consistently for phosphorus, chlorophyll-a, and related water quality variables. Nutrient and chlorophyll-a concentrations were measured in depth-integrated composite samples. Dissolved, oxygen, and pH were measured at discrete depths.

Spatial, seasonal, and yearly variations in trophic state indicators and excursion frequencies for the pH and dissolved oxygen standards are displayed in Appendix A. The station and yearly averages are based upon data from May thru September. Spatial variations are depicted by average values for 11 stations that were consistently sampled for phosphorus, chlorophyll-a and related water-quality variables: Agency Lake (AN, AS); Main Lake (MN, SB, ER, ML, WB, NB, PM, FB); and Pelican Bay (PB) (Figure 2). Spatial variations in water quality are considered in developing an appropriate algorithm for computing a lake-mean concentration on each sampling date for use in the TMDL derivation.

The Pelican Bay station (PB) has substantially better water quality, as compared with the other stations. This embayment is relatively sheltered from the open waters of the Lake and is flushed by inflows from springs. The Pelican Bay station is not considered representative of the lake as a whole (Kann, 1998) and is therefore excluded from the computation of lake-mean values used in the TMDL derivation.

As illustrated in Appendix A, May-September average phosphorus concentrations at Agency Lake stations (AN & AS, 200-240 ppb) exceed concentrations at the main lake stations (130-200 ppb), and the lake outflow (~100 ppm). Spatial variations are less evident for water quality indices, including chlorophyll-a, pH, and pH excursion frequencies. Effects of variations in the spatial distribution of sampling stations on a given date can be reduced by averaging the measurements from Agency and the main lake separately before computing the lake-wide mean.

Based upon the spatial and temporal patterns discussed above, the following algorithm has been applied to develop a time series of lake-mean water-quality measurements for use in deriving the TMDL:

1. Select data from 11 primary stations sampled for phosphorus, chlorophyll-a and other relevant water quality variables (AN, AS, ER, FB, ML, MN, NB, PM, SB, WB, PB)

2. Compute excursion counters (0 or 1) for each sample, variable (pH, dissolved oxygen, chlorophyll-a) and criterion level;
3. Average the measurements and excursion counters for each station and date;
4. Average the station-means within each two-week sampling interval and lake (Agency vs. Klamath, excluding Pelican Bay); these intervals are identical to those used by Kann & Walker (2001) in formulating the water and nutrient balances.
5. For each sampling interval when both lakes were sampled, compute an area-weighted lake mean from the Agency and Klamath Lake means using weights of 35.6 km<sup>2</sup> and 235.4 km<sup>2</sup>, respectively.
6. On 17 (generally winter & early spring) days when only the outlet station (FB) was sampled, multiply the outlet phosphorus concentration by 1.15 to estimate the lake-mean total phosphorus concentration. This adjustment is based upon the ratio of the geometric mean outlet concentration to the geometric mean lake concentration in sampling rounds when both the outlet and the lakes were sampled.

## **5.0 Nutrient & Algal Dynamics**

### **5.1 Phosphorus Cycling**

Mass balances developed by Kann & Walker (2001) indicate that approximately 14% of the Water Year 1992-1998 external phosphorus load was retained in lake sediments (Table 1). Phosphorus is recycled rapidly into the water column during late spring and early summer. Recycling is apparently triggered by photosynthetically-induced increases in pH, which liberates otherwise iron-bound phosphorus from lake bottom sediments

(Kann, 1993; 1998; Walker, 1995). This recycling mechanism is facilitated by low alkalinity, low calcium content, shallow depths, and algal nitrogen fixation. Probably as a consequence of geologic factors (volcanic soils), inflows from the Wood River (Figure 1) have extremely low calcium concentrations ( $< 5$  ppm, Campbell, 1993). Low calcium content is particularly important because seasonal internal phosphorus loading would otherwise be controlled by calcite and calcium phosphate precipitation at high pH levels (Stumm & Morgan, 1970). Apart from the pH effect, phosphorus recycling is also facilitated by vertical migration of bluegreen algae (Barbiero & Kann, 1994).

## 5.2 Algal Dynamics

Blooms in Upper Klamath Lake are typically dominated by bluegreen algae, primarily *Aphanizomenon*, but also including *Microcystis*, *Anabaena*, & *Oscillatoria* (Kann, 1998). Sas (1989) showed that bluegreens (primarily *Oscillatoria*) tend to dominate algal populations in shallow European lakes with total phosphorus concentrations exceeding 50-100 ppb. Bluegreen dominance in such lakes is promoted by their abilities to fix nitrogen, grow at low light intensities, and migrate vertically (Sas, 1989). The last factor enables algal cells to seek depth intervals with optimum growth conditions (light intensity, nutrient concentrations) during calm periods. These benefits are eliminated during periods of high winds, when the vertical distribution of cells is controlled by turbulence. Phosphorus recycling may be further enhanced by increases in pH at the sediment-water interface intensified when algal growth is concentrated along the bottom.

## 5.3 Seasonal Variations

Seasonal variations in lake phosphorus concentration, chlorophyll-a, pH, and excursion frequencies for the relevant pH standard ( $<9$ ) and dissolved oxygen standard (6 ppm) are shown in Figure 3. These monthly averages are based upon data from the individual stations (before spatial averaging). Excursions from the pH $<9.0$  standard occur most often during June & July (58%-89% of samples, respectively), coincident with peak chlorophyll-a levels and peak algal growth rates (as measured by the rate of chlorophyll-a



increase). These excursions are apparently driven by photosynthetic removal of carbon dioxide (Kann, 1998; Kann & Smith, 1999; Walker, 1995). Correlations among phosphorus, chlorophyll-a, and pH derived from June and July samples are used below as a basis for estimating a lake phosphorus target range to achieve compliance with the pH standard.

Excursions from the dissolved oxygen standard occur most often during August (35% of the samples). These are likely to be driven by algal respiration and decay of algal detritus, particularly during bloom die-off events in mid to late summer. Although linkages between phosphorus levels and oxygen excursions are conceptually strong, quantitative expression of these relationships using empirical or mechanistic models would be difficult. Difficulties arise from the fact that depressed oxygen levels represent integral responses to cumulative loads, antecedent conditions, weather, and unpredictable die-off events. Precise measurement of oxygen excursion frequency is complicated by diel variations in oxygen.

#### 5.4 Year-to-Year Variations

Correlations between May-September average total phosphorus concentrations and excursion frequencies for pH, dissolved oxygen, and chlorophyll-a are shown in Figure 4. Total P concentration is correlated with pH excursion frequencies ( $\text{pH} > 9$ ,  $r^2 = 0.72$ ) and bloom frequency ( $\text{Chl-a} > 100$  ppb,  $r^2 = 0.62$ ), but not with oxygen excursion frequency ( $\text{DO} < 6$  ppm,  $r^2 = 0.11$ ). As represented by log-linear regressions, the slopes of the phosphorus response curves tend to decrease with increasing phosphorus concentrations. This reflects the likelihood that other growth-limiting factors become increasingly important at higher phosphorus levels.

Correlations between June-July average total phosphorus concentrations and excursion frequencies for pH, dissolved oxygen, and chlorophyll-a are shown in Figure 5. Correlations between phosphorus and pH excursion frequency ( $\text{pH} > 9$ ,  $r^2 = 0.43$ ) and bloom frequency ( $\text{Chl-a} > 100$  ppb,  $r^2 = 0.59$ ) are less strong than those observed for the

May-September average period (Figure 4). As demonstrated below, correlations during June & July are much stronger when analyzed on a sampling-event basis. The relatively weak, but statistically significant ( $p < 0.10$ ) correlation between phosphorus and June-July oxygen excursion frequency ( $< 6$  ppm,  $r^2 = 0.30$ ) supports the hypothesis that improvements in the oxygen regime would result from reductions in phosphorus levels. The strong correlation between dieoff of algal blooms (as reflected by the decrease in mean chlorophyll-a between July and August) and minimum dissolved oxygen levels in July-August is also consistent with this hypothesis (Perkins et al., 2000).

Generally, correlations on a yearly- or seasonal-average basis are of limited use for estimating a phosphorus target range to achieve pH compliance because the averages are computed over a wide range conditions (reflecting the strong seasonal dynamics) and require considerable extrapolation of the data. For example, the regression between pH excursion frequency & phosphorus shown in Figure 4 can be solved for the phosphorus concentration corresponding to 0% excursion frequency. The target estimate (~69 ppb) is uncertain because it requires extrapolation of the regression model well beyond the range of the observed seasonal averages (130 - 220 ppb).

### 5.5 Biweekly Variations

This section describes correlations among phosphorus, chlorophyll-a, and pH on a biweekly (sampling event) basis during June & July, the months with maximum algal growth rates and pH excursion frequencies (Figure 3). Given the strong seasonal dynamics and wider range of phosphorus concentrations, the biweekly time scale is preferable to the seasonal-average time scale for estimating the phosphorus target range. The lake phosphorus target represents an intermediate step in the TMDL derivation. Ultimately, the TMDL is estimated based upon direct simulations of pH excursion frequency as a function of external phosphorus load and other controlling factors. Correlations on a biweekly scale are also required for linking with the dynamic mass-balance model used for that purpose.

The following linkage of empirical models relate phosphorus concentration to chlorophyll-a and pH excursion frequency during June & July:

$$\ln(\text{Chl-a}) = -5.41 + 2.09 \ln(\text{P}) \quad [r^2 = 0.65, \text{SE} = 0.53] \quad (1)$$

$$\text{pH} = 6.59 + 0.57 \ln(\text{Chl-a}) \quad [r^2 = 0.87, \text{SE} = 0.20] \quad (2)$$

$$\text{Freq} [\text{pH} > 9] = 1 - \text{Normal} [ ( 9 - \text{pH} ) / S_{\text{pH}} ] \quad [r^2 = 0.97, \text{SE} = 0.07] \quad (3)$$

where,

P = Lake-Mean Total Phosphorus (ppb)

Chl-a = Lake-Mean Chlorophyll-a (ppb)

pH = Lake-Mean pH

$S_{\text{pH}}$  = Spatial standard deviation of pH values on a given sampling date = 0.25

Normal(x) = Cumulative standard normal frequency distribution (integral from  $-\infty$  to x)

Frequency = Fraction of measurements with pH exceeding 9.0 on a given sampling date

Calibration results are shown in Figure 6. The models have been calibrated to lake-mean values from 24 sampling events that occurred during the peak algal growth season (June & July), when most of the historical pH excursions occurred (Figure 3) and when chlorophyll and pH levels are apparently most responsive to phosphorus levels.

Seasonal-average correlations (Figures 4 & 5) indicate that chlorophyll-a and pH excursion responses to total phosphorus are less steep at extremely high phosphorus concentrations. This may reflect the fact that highest phosphorus levels tend to occur in late July & August when bloom die-offs are frequently observed (Perkins et al, 2000). Maximum pH excursion frequencies tend to occur earlier in the season, when algal growth rates are highest. Data in the low-phosphorus range are clearly more relevant for calibrating models to be used in estimating the phosphorus target to achieve pH compliance. Accordingly, the calibration dataset is restricted to phosphorus

concentrations less than 190 ppb. This threshold has been selected by examining model residuals after fitting the model using alternative threshold values. Within this concentration and month range, model residuals are uncorrelated with other factors that could potentially influence algal response to phosphorus, including temperature, surface light intensity, depth, and inorganic N/P ratio.

The first model explains 65% of the variance in the chlorophyll-a concentration. The log-log form of the relationship has been applied to a wide range of lake and reservoir data sets (Jones & Bachman, 1976; Sas, 1989; Walker, 1985). The calibrated slope in this case (2.1) exceeds the 0.7 to 1.5 range typically derived from other datasets. This may reflect the favorable growth environment in Upper Klamath Lake (primarily, shallow depth) and characteristics of dominant bluegreen algal species.

The second model explains 87% of the variance in the lake-mean pH values. The log-linear form of the pH/chlorophyll-a regression suggests a linear relationship between hydroxyl ion concentration and chlorophyll-a. The form of the model and high correlation are consistent with the hypothesis that elevated pH levels are driven by algal photosynthesis.

The spatial distribution of pH values on a given sampling date is represented by a normal distribution with a standard deviation of 0.25 pH units. This value has been estimated from a least-squares fit of the observed  $\text{pH} > 9.0$  and  $\text{pH} > 9.5$  excursion frequencies. Figure 6 shows observed and predicted frequencies of pH values exceeding 9.0 and 9.5 based upon the measured lake-mean pH on a given sampling date.

The regression models can be coupled to predict mean pH and excursion frequencies as a function of total phosphorus concentration (Figure 7). The linked models indicate that a lake-mean pH of 9.0 corresponds to a mean chlorophyll-a concentration of ~66 ppb. Lake-mean phosphorus concentrations of ~100 ppb and ~75 ppb correspond to pH excursion frequencies of 50% and 10%, respectively, on any sampling date in June and July.

Observed total phosphorus concentrations are plotted along with predicted chlorophyll-a and pH values in Figure 8. Symbols show the paired phosphorus, chlorophyll-a, and pH values used in model calibration. On dates in June & July when the maximum phosphorus concentration exceeded 190 ppb (upper limit of model calibration range), a phosphorus concentration of 190 ppb is used to predict chlorophyll-a and pH. The model linkage adequately captures peak responses in each year. Yearly maximum pH levels occur during the model calibration months, when both chlorophyll-a concentrations and growth rates tend to be highest. Rapid increases in total P and chlorophyll-a during this period reflect the late spring algal bloom accompanied by high pH levels and phosphorus releases from bottom sediments.

Figure 9 plots pH excursion frequencies as a function of total phosphorus for alternative data-averaging methods:

- Lake-wide means, sampling events in June-July (calibration)
- Means by Station & Year, June-July,  $\geq 3$  samples per year
- Means by Lake Region & Year, June-July (Klamath, Agency, Pelican Bay)
- Means by Month (All Sites in Klamath and Agency Lakes)

The data distributions are generally consistent with pH vs. phosphorus relationship derived from the lake-mean values by sampling event. As discussed above, the model over-predicts excursion frequencies at phosphorus concentrations  $>190$  ppb, apparently because of growth limitation by factors other than phosphorus. In the low phosphorus range, data from Pelican Bay are consistent with a phosphorus threshold of 40-60 ppb for the onset of pH excursions. The model fits data from the main lake, but tends to over-predict average pH excursion frequencies in Agency Lake. This is primarily attributed to the fact that phosphorus concentrations frequently exceed 200 ppb in Agency Lake during June & July.

## 5.6 Role of Nitrogen

Figure 10 shows year-to-year variations in phosphorus, nitrogen, and chlorophyll-a concentrations during the critical months of June and July, when algal growth rates and pH excursion frequencies are highest. Year-to-year variations in these parameters are highly correlated. Total N/P ratios are relatively constant and slightly above the algal physiologic range (7-12). Because of nitrogen fixation, the Total N/P ratio is probably regulated more by the nutrient quotas of algal cells than by external nutrient loads. Variations in total nitrogen can be viewed more as symptoms than as a causes of algal growth. Inorganic N/P ratios are more reliable indicators of the limiting nutrient. As a consequence of apparent decreases in soluble reactive P and increases in inorganic N concentrations, inorganic N/P ratios increased sharply from  $< 4$  in 1990-1995 to 10-25 in 1996-1999. These variations are thought to be related to variations in climatologic factors, such as wind speed (Kann, J., personal communication).

As a consequence of algal nitrogen fixation, the average outflow total nitrogen load was 3.5 times the inflow load in 1992-1999 (Table 1). Although fixation of nitrogen requires a substantial amount of energy (Sas, 1989), the prolific bluegreen blooms observed in Upper Klamath Lake are evidence that sufficient energy is available. Residuals from the phosphorus/chlorophyll-a regression in Figure 6 are uncorrelated with the inorganic N / SRP ratio typically used as an indicator of nitrogen limitation. While nitrogen limitation may be factor later in the growing season, there is no evidence that the energy requirement for nitrogen fixation is actually limiting algal densities during the critical months of June and July, when energy supply (solar radiation), algal growth rates, and pH excursion frequencies are highest.

The phosphorus TMDL strategy is based upon assumptions that phosphorus levels ultimately control algal growth and that reductions in external phosphorus loads will drive the system towards an increasingly phosphorus-limited condition. Attempts to control algal growth through selective reduction in external nitrogen load would likely be futile. Phosphorus reduction is the standard and most-effective approach to

eutrophication control (Sas, 1989; Cooke et al, 1993. As a practical matter, implementation of a phosphorus control program in this watershed would be expected to reduce external loads of both phosphorus and nitrogen, so that such a program would result in reductions in algal growth & pH excursion frequency, even if external nitrogen loads were partially controlling.

## **6.0 Model Development**

This section describes the development of a dynamic mass balance model that predicts lake responses (phosphorus, chlorophyll-a, pH) as a function of external phosphorus load and other controlling factors. Model structure is illustrated in Figure 11. The model is coded in an Excel 2000<sup>TM</sup> workbook. Mass-balance simulations are performed at a biweekly time step, which is consistent with the strong seasonal dynamics observed in the Lake, the interval used in formulating lake water and mass balances (Kann & Walker, 2001), and the lake sampling interval. The model tracks the phosphorus balances of the water column and surface sediment layer. The latter is included because of the importance of internal phosphorus recycling in this lake. Equations, variable definitions, and parameter estimates are listed in Tables 2, 3, & 4, respectively.

The model is driven by the biweekly hydrologic and climatologic time series shown in Figure 12. Average water temperatures in each biweekly interval are estimated using a regression model relating measured water temperatures to antecedent air temperature and solar radiation. Solar radiation data are derived from the closest monitoring station with a continuous record (Tule Lake, California). As described in Table 2, total daily radiation measurements are translated to photosynthetically-active radiation (PAR) based upon a correlation with PAR measurements taken in Agency Lake (Campbell, 1993).

Phosphorus is partitioned into two compartments (algal & non-algal, Figure 11). These are removed from the water column by algal settling and a first-order volumetric reaction, respectively. The latter reflects the combined result of physical, chemical, and biological processes influencing phosphorus retention and recycling within the Lake (Vollenweider,

1969). The mass balance includes a term representing recycling from bottom sediments that occurs regularly each summer and is responsible for seasonal peaks in phosphorus, chlorophyll-a, and pH (Figure 3). Recycle rates are assumed to be proportional to the predicted spatial frequency pH values exceeding a threshold value (calibrated at  $\text{pH}^* = 9.1$ ) and to the quantity of phosphorus stored in the active sediment layer during each two-week period. This pH-dependence introduces a strong feedback loop in the model. If phosphorus levels are sufficiently high at the start of the growing season, this feedback loop causes phosphorus, chlorophyll-a, and pH levels to increase at accelerated rates until algal growth is curtailed by light and/or temperature later in the growing season. Since pH is strongly correlated with algal densities during periods with recycling rates are highest, the pH-dependent recycling simulated in the model represents the combined effects of a variety of recycling mechanisms that would be correlated with algal density or pH, including de-sorption of phosphate from sediments triggered by high pH and/or anoxic conditions at the sediment-water interface and vertical migration of algal cells.

Chlorophyll-a concentration is predicted using standard kinetic formulations that account for algal growth limitation by temperature, light, and phosphorus. (Bowie et al, 1985; Forsberg & Shapiro 1980; Walker, 1985). With temperature and light factors, this model has wider seasonal applicability than the simple phosphorus/chlorophyll-a regression model developed above for the June-July period (Figure 6). Consistent with the formulation described by Forsberg & Shapiro (1980), chlorophyll-a levels are assumed to reach equilibrium with ambient phosphorus, chlorophyll-a, and temperature regimes within each two-week simulation interval. This assumption appears to be justified, given that simulated algal growth rates are on the order of 20-30% per day during the growing season. A more complex model operating at a daily time step would be required for a full dynamic simulation of chlorophyll-a.

Talling's (1957) model is used to predict algal growth rate as a function of light intensity (PAR). The corresponding model parameter estimate (onset of light saturation =  $214 \mu\text{E}/\text{m}^2\text{-sec}$ ) was measured by Pechar (1992) for *Aphanizomenon flos-aquae*, the dominant algal specie in Klamath & Agency Lakes (Kann, 1998).



Algal ( $0.0097 \text{ m}^{-1}/\text{ppb Chl-a}$ ) and non-algal ( $1.32 \text{ m}^{-1}$ ) light extinction coefficients have been calibrated against simultaneous measurements of visible light attenuation and chlorophyll-a made during June & July (Figure 13). Scatter in the extinction coefficients (possibly related to organic detritus produced after die-off of algal blooms) increases later in the growing season, but the mean coefficient values are relatively stable.

Maximum growth and respiration rates are predicted as linear functions of water temperature (Figure 14). The minimum temperature for algal growth (14 deg C) is calibrated to match the timing of observed spring blooms. The timing of the spring bloom is very sensitive this parameter and to water temperatures in May-June. This is consistent with the correlation between the timing of spring algal blooms and April-May air temperatures reported by the USGS (Wood et al., 1996). Based upon coefficients listed by Bowie et al (1985), a maximum growth rate of  $1.2 \text{ day}^{-1}$  at 20 deg C (for bluegreens) and respiration rate of .06 day (5% of maximum growth) are assumed. Consistent with observed seasonal variations in chlorophyll-a, growth rates are assumed to level off at temperature exceeding 20 degrees C, but respiration rate continues to increase at a linear rate.

The pH vs. chlorophyll-a regression model (Figure 6) has been modified for application beyond the June-July period. The model predicts pH as a function of chlorophyll-a and Julian Day (Figure 15). The latter term is necessary in order to simulate the observed decline in pH at a given chlorophyll-a that occurs in late July, August, and September.

Model calibration results are shown in Figures 16-21. The calibration process has been guided by least-squares criteria and examination of model residuals. Residuals have been examined as a function of season, time, each driving variable (flow, depth, light), and each predicted variable. Coefficients have been adjusted within reasonable ranges (Bowie et al., 1985) based upon the data fit and residual patterns. The calibration sequence is as follows:

1. Calibrate pH model parameters by multiple regression vs. observed chlorophyll-a and Julian Day (Figure 15).
2. Calibrate chlorophyll-a model parameters based upon literature values (Bowie et al., 1985; Pechar, 1992) and least-squares fit of the observed chlorophyll-a data computed from observed lake phosphorus, water temperature, depth, solar radiation, and light extinction values. The settling rate parameter has been estimated by a least squares fit of chlorophyll-a data from June & July, the period with the highest pH excursion frequencies. The linked chlorophyll-a and pH calibrations are shown in Figure 16. These predictions are driven by the measured total phosphorus time series shown at the top of the figure.
3. Calibrate the non-algal P loss rate ( $0.012 \text{ day}^{-1}$ ) to observed lake P concentrations in March-May, when the algal P compartment is minimal. This parameter is critical for TMDL calculations because it has a strong influence on phosphorus concentrations at the start of the growing season. Observed and predicted values are shown in Figure 17. The potential significance of the apparent decreasing trend in spring phosphorus is discussed further below.
4. Calibrate the phosphorus recycling parameters ( $\text{pH}^*$  &  $K_R$ ) based upon a least-squares fit of data from May-July in 1994-1998. Data from the remaining months (August-April) and years (1991-1993) are reserved for model testing. TMDL estimates are most sensitive to these parameters. Given the ultimate objective of predicting pH, the least-squares objective function is the product of the residual mean squares for phosphorus, chlorophyll-a, and pH. Resulting model parameter estimates are  $\text{pH}^* = 9.1$  and  $K_R = 0.53$ . Observed and predicted internal recycling rates are plotted as a function of pH, season, and date in Figure 18. Simulated biweekly phosphorus fluxes (inflow, gross sedimentation, recycling, change in storage, & outflow) are shown in Figure 19.

Figure 20 shows observed and predicted time series for lake phosphorus, chlorophyll-a, pH, and pH excursion frequency driven by phosphorus load and hydrologic time series. Square symbols are observations used in calibrating phosphorus recycling parameters. Circular symbols are observations reserved for model testing. Observed and predicted values are plotted against Julian date in Figure 21. Additional analysis would be required to develop uncertainty estimates for the calibrated model parameters and model predictions.

While the model generally tracks phosphorus, chlorophyll-a and pH dynamics in spring and early summer, it does not predict sudden bloom declines that tend to occur in August. In particular, August-September bloom die-off events in 1992-1994 are not represented, so the model tends to over-predict phosphorus and chlorophyll-a concentrations during and after this period. It would be possible to “force” bloom crashes with a seasonal loss term or declining temperature dependence. Given the unknown mechanism, however, it is not clear that die-off events would continue to occur under TMDL conditions. Since the model performs well during the critical period for pH excursions, inability to predict bloom die-off events later in the season does not limit its use in estimating a TMDL to meet the pH standard.

Figure 22 shows the relative importance of phosphorus, light, and temperature as factors controlling algal growth over the 1990-1999 period. Once the growing season is triggered by increases in temperature and light in late May/early June, chlorophyll-a levels are limited primarily by phosphorus concentration. Later in the summer, algal densities are controlled when reductions in surface light intensity, decreases in light penetration (self-shading), sub-optimal temperatures, and/or random die-off events.

## **7.0 TMDL Simulations**

To estimate the TMDL, simulations have been performed for a range of assumed phosphorus load reductions (relative to the 1992-1998 period of record). In each case, the initial lake phosphorus concentration and sediment phosphorus storage (on April 7,

1991) are set at the simulated values for April 18, 1998. This procedure essentially chains multiple simulations of the same 7-year hydrologic record. It is necessary in order to predict steady-state responses to a given phosphorus loading regime.

Results are shown in the following figures:

Figure 23 Phosphorus, Chlorophyll-a, & pH Simulations

Figure 24 Excursion Frequencies vs. Phosphorus Load Reduction

Figures 25 pH Simulations with Estimated Background Phosphorus Loads

Generally, results indicate a rapid decline in algal bloom frequencies pH excursion rates as load reduction increases from ~30 to ~50%. The adoption of a particular TMDL will depend upon the required pH compliance rate. Compliance rate can be defined based upon spatial averaging method (% of measurements vs. % of lake-mean values), season (annual vs. critical season (June-July)), return interval (long-term-average vs. 1/7-year maximum), and maximum excursion rate (e.g., 5%, 10 % of values exceeding 9.0).

Simulation results for load reductions ranging from 30 to 50% (Figure 23) suggest that pH excursion rates would be highest under hydrologic and reservoir operating conditions experienced in 1993, 1996, and 1997. These generally correspond to years when the spring-time phosphorus loading pulse was greatest (Figure 12). With lower phosphorus concentrations, algal densities, and light extinction coefficients under reduced loads, light limitation would be less important as a factor controlling algal growth, as compared with historical conditions. As a consequence, variations in depth have less influence on peak algal densities and pH under reduced loading regimes, as compared with historical conditions (e.g., peak algal response in 1992, the year with the lowest springtime water level; see Figures 12 & 16).

Water & phosphorus balances under historical and TMDL conditions are listed in Table 5 for a nominal load reduction of 40%. Under Water Year 1992-1998 conditions, the watershed load averaged 177 mtons/yr (range = 107 to 236 mtons/yr), the total load

averaged 182 mtons/yr (range = 112 to 241 mtons/yr), and the flow-weighted-mean inflow concentration averaged 106 ppb (range = 97 to 118 ppb). A reduction of 40% in the average watershed load corresponds to an average watershed load of 111 mtons/yr (range = 69-146 mtons/yr) and to an average inflow concentration of 66 ppb (range = 58 to 71 ppb). The average inflow concentration is a convenient expression because it factors out much of the year-to-year hydrologic variability.

Figure 25 compares simulated pH excursion rates and lake-mean values for existing loads with values predicted for background loads estimated by Kann & Walker (2001). Background loads (excluding all anthropogenic sources) correspond to load reductions of 33-47% in the 1992-1998 loads. This range brackets the estimated anthropogenic load percentage for Agency Lake (44%, Walker, 1985). The range is based upon the 80% confidence interval of the mean phosphorus concentration measured in 8 springs within the Agency/Klamath watershed (55 –70 ppb). Observed background concentrations are lower (typically below 40 ppb) in the Sprague River, which accounts for 36% of the lake inflows (Table 1). In addition, this estimation procedure does not account for trapping of phosphorus that is likely to occur in existing wetland areas (e.g., Williamson, Sycan, Sprague River basins, Figure 1). Therefore, actual background loads may be somewhat lower than those estimated. Because drainage of wetland areas adjacent to the Lake has reduced its effective surface area and eliminated wetland functions that may include nutrient retention, the assimilative capacity (TMDL) under natural conditions was probably greater than it is today. For the above reasons, excursion rates under natural conditions (without watershed and reservoir development) were probably lower than those shown in Figure 25.

## **8.0 Discussion**

Figure 26 shows indications of decreasing trends in both the average inflow concentration (~2.8 %/yr) and the average lake concentration (9%/yr) in Spring over the 1992-1998 period. The apparent trend in inflow concentration is not explained based upon variations in flow. While a portion of the trend in lake phosphorus concentration may be attributed

to changes in water-level management (increase in depth, Figure 12), the correlation between reductions in inflow and lake concentrations is evidence that control of external loads will be effective in reducing lake phosphorus levels and resulting algal blooms. There is some indication that these trends may have leveled off after 1996. Responses to load reduction are also consistent with the  $\sim 2.1$  %/yr decline in surface sediment P storage predicted by the sediment phosphorus mass balance over the 1991-1998 historical record.

If the apparent trend in inflow concentration ( $-2.8\%/yr$ ) is “real”, the long-term-average inflow concentration at the end of the time series (1998) would be 92% of the 1992-1998 mean. This suggests that approximately 8% out of the 30-50% load reduction potentially required under the TMDL may have already been achieved in 1998. This reduction may reflect watershed management efforts and public purchase of major tracks of diked and drained areas adjacent to the Lake that were formerly used for grazing. For example, Wood River Ranch (2,880 acres) was purchased by the Bureau of Land Management in 1995. Agency Lake Ranch (6,787 acres) was purchased by the Bureau of Reclamation in 1998. Benefits of the latter purchase and of improvements in water management on either property would not be reflected in the 1992-1998 dataset. Further evaluation of trends could be conducted by updating the inflow, lake, and model datasets to include data from recent years (1999 and 2000).

Phosphorus concentration at the start of the growing season has a strong influence on the spring algal pulse and on the likelihood of triggering the recycling mechanism that results in summer pH excursions. Under a given depth regime, spring lake concentrations largely dependent upon watershed inflow concentrations. TMDL simulation results can be re-expressed as relatively simple relationships among average inflow concentration, spring phosphorus, and June-July pH excursion frequency (Figure 27). The scatter plots show observed values for 1992-1998 and simulated values for 1992-1998 with assumed load reductions of 0%, 30%, 40%, and 50%. June-July average pH excursion rates less than 10% are achieved in years when the spring phosphorus concentration is less than  $\sim 30$  ppb (vs. 44 to 81 ppb historical range, Table 5) and the average inflow concentration

is less than ~60 ppb (vs. 97 to 118 ppb historical range). The 60 ppb inflow concentration is within the range of estimated background concentrations (55 – 70 ppb, Kann & Walker, 2001).

The simulations assume that the sediment accretion rate (burial velocity, Table 2) is independent of external load. If the burial velocity were assumed to be proportional to external P load, the predicted June-July pH excursion rate would increase from 11 to 16% for a 40% load reduction scenario. The sediment phosphorus simulation could be refined with further analysis of the sediment core data (Eilers et al, 2000).

The simulations discussed above reflect steady-state responses of the lake to alternative load reductions under a range of hydrologic conditions. “Steady-state” refers to equilibration of water-column and sediment phosphorus storage. The sedimentation and recycling terms in the model represent net quantities. Because of the considerable quantities of labile phosphorus that are stored in the surface sediments, a delay in the response to reductions in external loads would be expected (Sas, 1989). Further refinements to the model would be required to simulate the transient response following TMDL implementation. A similar shallow-lake phosphorus mass-balance model with these components has been recently developed for Lake Okeechobee (Walker, 2000ab).

## **9.0 Conclusions**

Conclusions are summarized in Section 2.0 (“Summary of TMDL Derivation”).

## 10.0 References

- Barbiero, R.P. & J. Kann, "The Importance of Benthic Recruitment to the Population Development of *Aphanizomenon flos-aquae* and Internal Loading in a Shallow Lake", Journal of Plankton Research, Vol. 16, No. 11, pp. 1581-1588, 1994.
- Bowie, G.L., et al., "Rates, Constants, and Kinetics Formulations in Surface Water Quality Modeling", Environmental Research Laboratory, U.S. Environmental Protection Agency, Athens, Georgia, EPA/600/3-85/040, June 1985.
- Campbell, S., Editor, "Environmental Research in the Klamath basin, Oregon – 1992 Annual Report", U.S. Bureau of Reclamation, Technical Report R-93-16, 1993.
- Cooke, G.D., E.B. Welch, S.A. Peterson, P.R. Newroth, Restoration and Management of Lakes and Reservoirs, Lewis Publishers, 1993.
- Eilers, J., J. Kann, J. Cornett, K. Moser, A., St. Amand, & C. Gubala, "Recent Paleolimnology of Upper Klamath Lake, Oregon" prepared for U. S. Bureau of Reclamation, Klamath Falls, Oregon, December 2000.
- Forsberg, B.R. & J. Shapiro, "The Effects of Artificial Destratification on Algal Populations", in H.G. Stefan, ed., Surface Water impoundments, Proceedings of ASCE Conference, Minneapolis, Minnesota, pp. 851-864, 1980.
- Jones, J.R. & R.W. Bachman, "Prediction of Phosphorus and Chlorophyll Levels in Lakes", J. Water Pollution Control Federation, Vol. 48, pp. 2176-2182, 1976.
- Kann, J., "Limnological Trends in Agency Lake, Oregon – 1992", in pp. 91-137 in S.G. Campbell, Editor, "Environmental Research in the Klamath basin, Oregon – 1992 Annual Report", U.S. Bureau of Reclamation, Technical Report R-93-16, 1993.
- Kann, J., "Ecology and Water Quality Dynamics of a Shallow Hypereutrophic Lake Dominated by Cyanobacteria (*Aphanizomenon flos-aquae*)". Doctoral Dissertation, University of North Carolina, Curriculum in Ecology, Chapel Hill, North Carolina, 1998.
- Kann J. & W. W. Walker, "Nutrient and Hydrological Loading to upper Klamath Lake, Oregon, 1991-1998, prepared for Klamath Tribes Natural Resources Department & U.S. Bureau of Reclamation, 2001.
- Kann, J. & V.H. Smith, "Estimating the Probability of Exceeding Elevated pH Values Critical to Fish Populations in a Hypereutrophic Lake", Can. J. Fish Aquat. Sci., Vol. 56, pp. 2262-2270, 1999.



Kann, J., "Compilation of Klamath Tribes Upper Klamath Lake Water Quality Data, 1990-1999", Aquatic Ecosystem Sciences LLC, prepared for Klamath Tribes Natural Resources Department, USBR Cooperative Studies, Electronic Excel File ULK90-99.XLS, December 1999.

Mortimer, C.H., "The Exchange of Dissolved Substances between Mud and Water in Lakes, Parts I & II, Journal of Ecology, Vol. 29, pp. 280-329, 1941.

Pechar, L. "Water Blooms of *Aphanizomenon flos aqua*: An Ecological Study of Fish Pond Populations", Arch. Hydrobiol/Supp. 90: 339-418, 1992.

Perkins, DL. J. Kann, C. G. Scopettone, "The Role of Poor Water Quality and Fish Kills in the Decline of Endangered Lost River and Shortnose Suckers in Upper Klamath Lake", U.S. Geological Survey, Biological Resources Division, submitted to U.S. Bureau of Reclamation, Klamath Falls Project Office, Final Report, September 2000.

Sas, H., Lake restoration by Reduction of Nutrient Loading: Expectations, Experiences, & Extrapolations, Academia Verlag, Richarz, 1989.

Snyder, D.T. and Jennifer L. Morace, "Nitrogen & Phosphorus Loading from Drained Wetlands Adjacent to Upper Klamath and Agency lakes, Oregon", Water-Resources Investigations Report 97-4059, U.S. Geological Survey, Portland, Oregon, 1997.  
Steele,

Steele, J.H., "Notes on Some Theoretical Problems in Production Ecology", in C.R. Goldman, ed., Primary Production in Aquatic Environments, University of California Press, Berkeley, pp. 393-398, 1965.

Stumm, W. & J.J. Morgan, Aquatic Chemistry, Wiley-Interscience, New York, 1970.

Talling, J.F., "Photosynthetic Characteristics of Some Freshwater Plankton Diatoms in Relation to Underwater Radiation", New Phytol., Vol. 56: pp. 29-50, 1957.

U.S. Environmental Protection Agency, "Protocol for Developing Nutrient TMDL's" Office of Water, EPA-841-B-99-007, November 1999.  
<http://www.epa.gov/owow/tmdl/nutrient/nutrient.html>

Vollenweider, R.A., "Possibilities and Limits of Elementary Models Concerning the Budget of Substances in Lakes", Arch. Hydrobiol. Vol. 66, No. 1, pp. 1-36, April 1969.

Walker, W.W., "Use of Hypolimnetic Oxygen Depletion Rate as a Trophic State Index for Lakes", Water Resources Research, Vol. 15, No. 5, pp. 1463-1470, 1979.

Walker, W.W., "Empirical Methods for Predicting Eutrophication in Impoundments, Phase II: Model Refinements", prepared for Office of Chief, U.S. Army Corps of

Engineers, Waterways Experiment Station, Vicksburg, Mississippi, TR E-81-9, Report 3, March 1985.

Walker, W.W., "Statistical Basis for Mean Chlorophyll-a Criteria", *Lake & Reservoir Management, Proceedings of Fourth Annual Conference, North American Lake Management Society, McAfee, New Jersey*, pp. 57-62, 1985b.

Walker, W.W., "A Nutrient-Balance Model for Agency Lake, Oregon", prepared for U.S. Department of the Interior, Bureau of Reclamation, Denver, Colorado, April 1995.

Walker, W.W. & K.E., Havens, "Relating Algal Bloom Frequencies to Phosphorus Concentrations in Lake Okeechobee", *Lake & Reservoir Management*, Volume 11, No. 1, pp. 77-85, 1995.

Walker, W.W., "Experience in Developing Phosphorus TMDL's for Shallow Lakes", presented at 20<sup>th</sup> Annual Symposium, North American Lake Management Society, Miami, Florida, November 2000a.

Walker, W.W., "Estimation of a Phosphorus TMDL for Lake Okeechobee", prepared for Florida Department of Environmental Protection & U.S. Department of the Interior, December 2000b.

Wetzel, R.G., *Limnology*, W.B. Saunders, Philadelphia, 1975.

Wood, T. M., G.J. Fuhrer, & J.L. Morace, "Relation Between Selected Water-Quality Variables and Lake Level in Upper Klamath and Agency lakes, Oregon", U.S. Geological Survey, Water-Resources Investigations report 96-4079, 1996.

## **List of Tables**

- 1 Average Nutrient & Water Balances for Water Years 1991-1998
- 2 Model Equations
- 3 Variable Definitions
- 4 Parameter Estimates & Hydrologic Inputs
- 5 Water & Mass Balances Under Historical & Hypothetical TMDL Conditions

**Table 1**  
**Average Water & Nutrient Balances, Water Years 1992-1998**  
**Kann & Walker (2001)**

<u>Term</u>	<u>Flow</u> <u>(hm<sup>3</sup>/yr)</u>	<u>Nutrient Load (metric tons /yr)</u>				<u>Flow-Wtd-Mean Concentration (ppb)</u>				<u>Dr. Area</u> <u>km<sup>2</sup></u>
		<u>Total P</u>	<u>SRP</u>	<u>Total N</u>	<u>Inorg-N</u>	<u>Total P</u>	<u>SRP</u>	<u>Total N</u>	<u>Inorg-N</u>	
Wood River above Weed Rd	253.2	22	17	36	8	86	69	142	32	334
Wood River below Weed Rd	40.7	13	11	36	2	331	277	892	47	57
SevenMile Crk @ Gauge	116.5	17	9	57	7	142	80	489	59	106
Sprague River @ Gauge	596.0	49	28	237	27	82	47	398	45	4238
Williamson R @ Gauge - Sprague & Sycan	320.5	38	30	111	13	118	94	347	40	3501
Ungauged Agric Pump Springs	52.9	21	12	124	23	388	222	2351	434	109
	288.2	18	15	34	16	63	53	119	57	1142
Total Watershed	1668.0	177	123	636	96	106	74	381	58	9487
Precipitation	126.1	5	5	27	27	39	39	215	215	271
Evaporation	249.4									271
Net Inflow	1544.7	182	128	663	123	118	83	429	80	9758
Lake Outflow	1524.8	160	36	2297	436	105	24	1506	286	9758
Storage Increase	19.9	-4	-2	-37	10					
Retention		25	94	-1597	-323					
Retention %		14%	73%	-241%	-263%					
Approximate Load Sources										
Background	1668.0	105	89	198		95 estimated from concentrations in regional springs				
Anthropogenic		72	34	438		1 computed by difference				
Atmospheric		5	5	27		27 from assumed atmospheric deposition rates				
Total		182	128	663		123 measured total				
% Anthropogenic		40%	27%	66%	1.2%					

**Table 2**  
**Model Equations\***

Water-Column & Sediment Phosphorus Mass Balances (integrated numerically):

$$dM/dt = \text{LOAD} + \text{RECYCLE} - \text{SEDIMENTATION} - Q_0 P$$

$$dS/dt = \text{SEDIMENTATION} - \text{RECYCLE} - \text{BURIAL}$$

$$S_0 = 10 A X_0 Z_S D_S$$

$$\text{SEDIMENTATION} = K_p V (P - B Y) + U B Y A$$

$$\text{BURIAL} = S U_B / Z_S$$

$$\text{RECYCLE} = K_{R1} S \text{ Freq}^*$$

Mean pH & pH Excursion Frequency:

$$\text{pH} = 7.93 + 0.534 \ln(B) - 0.006 \text{ Max}(\text{Julian Date}, 200)$$

$$\text{Freq}^* = 1 - \text{Normal}[(\text{pH} - \text{pH}^*) / S_{\text{pH}}]$$

Chlorophyll-a (solved numerically in each biweekly time step):

$$dB/dt = G_{\text{max}} F_L B (1 - YB/P) - RB - UBZ - BQ/V = 0$$

$$F_T = \text{Max}[0, (T - T_0) / (T_X - T_0)]$$

$$R = F_T R_X$$

$$G_{\text{max}} = G_X \text{ Min}(1, F_T)$$

Light-Dependence of Algal Growth Rate (Talling, 1957):

$$F_L = (I_M / I_K) / [1 + (I_M / I_K)^2]^{1/2}$$

$$I_M = I_0 [1 - \exp(-EZ)] / EZ$$

$$E = \alpha + \beta B$$

Photosynthetically Active Radiation:

$$\text{PAR (uE/m}^2\text{-sec, 24-hr average)} = 0.714 \text{ RAD (cal/cm}^2\text{-day)}$$

$$I_0 = (1 - f) \text{ PAR} (24 / D)$$

$$D = 7.72 \text{ acos}[-\tan((2\pi/360) \text{ Lat})] \tan(\delta)$$

$$\delta = 0.4102 \sin[(2\pi/360)(\text{Julian} - 80.25)]$$

\*For simplicity, units conversion factors are omitted from equations in table

**Table 3**

**Variable Definitions**

t	=	Time (days)
M	=	Phosphorus Mass in Water Column ( kg )
B	=	Chlorophyll-a Concentration (ppb)
P	=	Total P Concentration (ppb) = M / V
S	=	Mass of P Stored in Active Sediment (kg)
S <sub>0</sub>	=	Initial Value of S (kg)
P	=	Average Lake Total P Concentration (ppb)
U	=	Net Settling Rate for Algae P (m/day)
Z	=	Mean Depth (m)
A	=	Lake Surface Area (km <sup>2</sup> )
V	=	Mean Volume (hm <sup>3</sup> = million m <sup>3</sup> )
Freq*	=	Spatial Frequency of pH Values > pH*
Normal	=	Cumulative Standard Normal Frequency Distribution
F <sub>L</sub>	=	Light Limitation Factor
E	=	Light Extinction Coefficient (m <sup>-1</sup> )
I <sub>0</sub>	=	PAR Penetrating Water Surface, Average During Daylight Hours (μE / m <sup>2</sup> -sec )
I <sub>M</sub>	=	Depth-Averaged PAR (μE / m <sup>2</sup> -sec )
δ	=	Solar Declination Angle (radians)
F <sub>T</sub>	=	Temperature Scale Factor for Growth & Respiration
G <sub>max</sub>	=	Maximum Growth Rate During Daylight Hours at Current Temperature (day <sup>-1</sup> )
R	=	Respiration Rate at Current Temperature (day <sup>-1</sup> )

\* Other Parameters Defined in Table 4

**Table 4**  
**Parameter Estimates & Hydrologic Inputs**

**Parameter Estimates**

Sym	Description	Value	Note
K <sub>P</sub>	Gross Removal Rate for Non-Algal P (day <sup>-1</sup> )	.012	Calibrated to Spring P Conc.
U	Net Settling Rate for Algal P (m/day)	0.05	Calibrated to P & Chla Conc
pH*	Critical pH at ½ Max P Recycle Rate	9.1	Calibrated to P & Recycle
K <sub>R</sub>	P Recycle Rate at pH* (1/yr)	0.53	Calibrated to P & Recycle
S <sub>pH</sub>	Spatial Standard Deviation of pH	0.25	Figure 6
α	Non-Algal Light Extinction Coef. (m <sup>-1</sup> )	1.32	Regression, Figure 13
β	Algal Light Extinction Coef. (m <sup>-1</sup> / ppb )	0.0097	Regression, Figure 13
I <sub>k</sub>	Onset of Light Saturation (uE /m <sup>2</sup> -sec)	214	Talling, 1957; Pechar,1992
f	Light Reflectance Fraction	0.1	Wetzel, 1975; Pechar,1992
Lat	Lake Latitude (deg-North)	42.5	Map
T <sub>X</sub>	Ref. Temp., Max Growth Rate (deg-C)	20	Bowie et al., 1985; Chla Calib.
T <sub>O</sub>	Temperature at Zero Growth Rate (deg-C)	14	“ “
G <sub>X</sub>	Max Growth Rate at Ref. Temp. T <sub>X</sub> (day <sup>-1</sup> )	1.2	“ “
Y <sub>P</sub>	Algal Cell P Quota (mg P / mg Chl-a )	0.6	“ “
R <sub>X</sub>	Respiration Rate at Ref. Temp. T <sub>X</sub> (day <sup>-1</sup> )	0.06	“, “ 5% of Max. Growth Rate
U <sub>B</sub>	Sediment P Burial Velocity (mm/yr)	1.4	Eilers et al., 2000
Z <sub>S</sub>	Active Sediment Thickness (cm)	10	“
D <sub>S</sub>	Sediment Bulk Density (g/cm <sup>3</sup> )	.12	“
X <sub>0</sub>	Initial Sediment P Content (mg/kg)	1000	“

**Measured Hydrologic & Climatologic Inputs (see Figure 12):**

Sym	Description	Notes
LOAD	External P Load (Watershed + Atmos.) (kg/day)	Kann & Walker, 2001
Q <sub>O</sub>	Lake Outflow (hm <sup>3</sup> /day = 10 <sup>6</sup> m <sup>3</sup> / day)	Kann & Walker, 2001
A	Lake Surface Area (km <sup>2</sup> )	Kann & Walker, 2001
V	Mean Volume (hm <sup>3</sup> )	Kann & Walker, 2001
RAD	Total Solar Radiation (cal / cm <sup>2</sup> – day)	Tule Lake Weather Station
PAR	24-hr Avg. Photosyn. Active Solar Rad (μE/m <sup>2</sup> -s)	Agency L., Campbell 1993, Correl. vs. RAD
T <sub>A</sub>	Daily Mean Air Temperature (deg-C)	Klamath Falls Airport
T	Water-Column Temperature (deg-C)	Lake Data Correl. vs. T <sub>A</sub> & RAD
D	Day Length (hours)	Computed from Latitude & Julian Day

**Table 5**  
**Water & Mass Balances Under Historical & Hypothetical TMDL Conditions**

**Historical & TMDL Water Balances**

Water Year	Flows ( 10 <sup>6</sup> m <sup>3</sup> /yr)			Net Inflow	Increase Storage	Outflow	Area km <sup>2</sup>	Mean Depth m
	Inflow	Precip	Evap					
1992	919	73	272	721	-62	773	263	1.69
1993	1790	144	243	1691	169	1522	265	1.97
1994	1023	68	273	818	-210	1026	264	1.87
1995	1581	142	248	1475	230	1243	261	2.01
1996	2091	159	242	2008	-62	2063	269	2.16
1997	2221	155	237	2139	92	2026	269	2.16
1998	2074	139	222	1992	-9	1987	269	2.29
Mean	1671	126	248	1549	21	1520	266	2.02
Max	2221	159	273	2139	230	2063	269	2.29
Min	919	68	222	721	-210	773	261	1.69

**Historical Phosphorus Loads (kg/yr)**

Water Year	Watershed Inflow	Precip	Total Load	Storage Increase	Net Outflow	Retention	Inflow Conc ppb	Outflow Conc ppb	Observed June-July Lake Means ---->					
									Total P ppb	pH	Chl-a ppb	pH > 9 %	pH > 9.5 %	Spring P ppb
1992	108519	4861	113380	-53626	128322	38685	118	166	259	9.38	222	88%	36%	78
1993	202288	4861	207149	8336	134615	64198	113	88	116	8.85	92	52%	25%	81
1994	106931	4861	111792	-10928	98419	24302	105	96	141	9.29	126	72%	42%	55
1995	163629	4861	168491	90825	130135	-52469	103	105	167	9.39	168	81%	58%	65
1996	235935	4861	240796	-44522	175811	109507	113	85	102	9.03	98	61%	20%	48
1997	216476	4861	221337	6199	249156	-34018	97	123	176	9.19	171	74%	41%	44
1998	203853	4861	208714	-12270	194375	26609	98	98	110	9.08	108	48%	19%	53
Mean	176804	4861	181666	-2284	158690	25259	106	104	153	9.17	141	68%	34%	61
Max	235935	4861	240796	90825	249156	109507	118	166	259	9.39	222	88%	58%	81
Min	106931	4861	111792	-53626	98419	-52469	97	85	102	8.85	92	48%	19%	44

**Phosphorus Balance for a Hypothetical Watershed Load Reduction of**

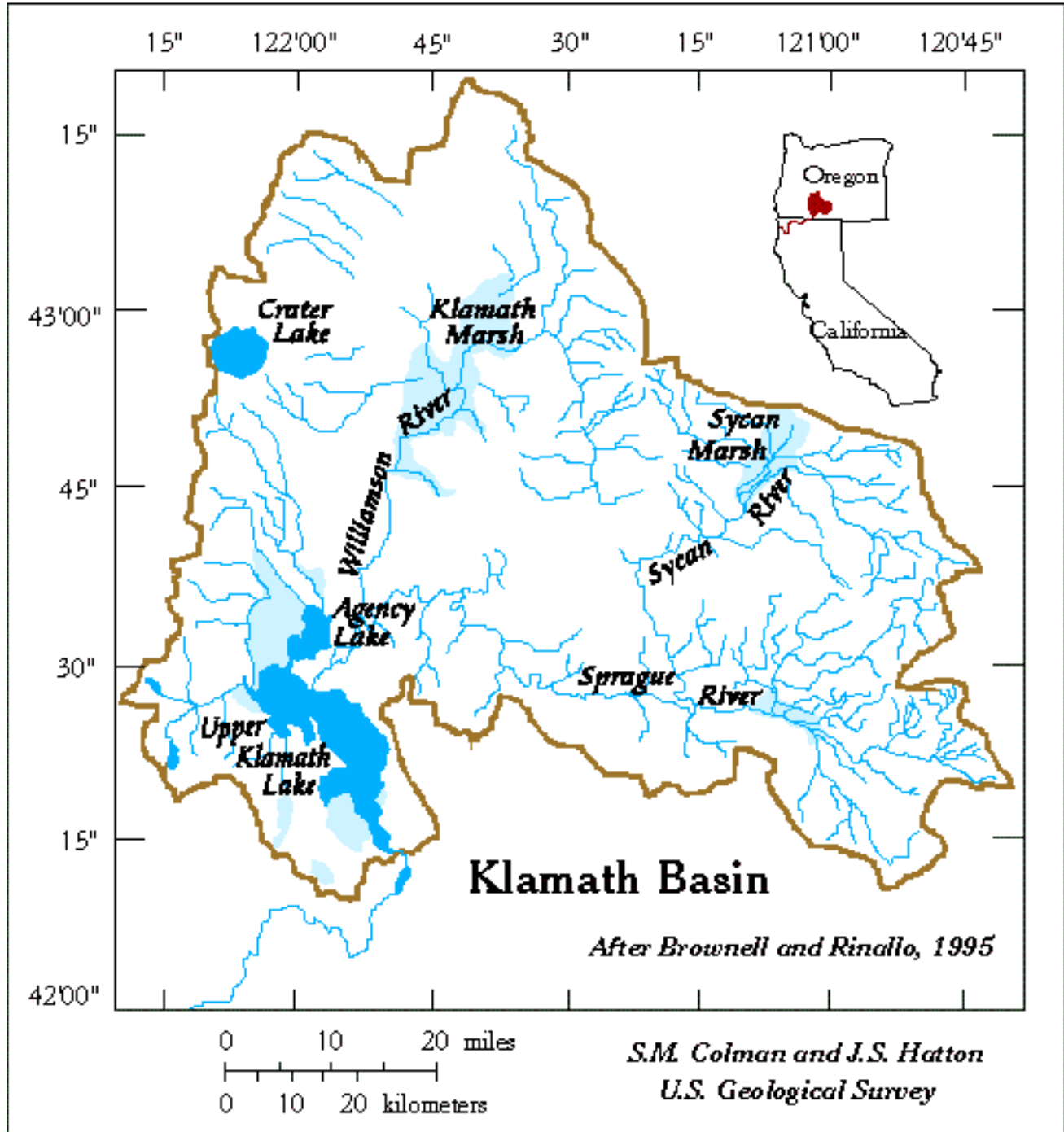
Water Year	Watershed Inflow	Precip	Total Load	Storage Increase	Net Outflow	Retention	Inflow Conc ppb	Outflow Conc ppb	40% Predicted June-July Lake Means ---->					
									Total P ppb	pH	Chl-a ppb	pH > 9 %	pH > 9.5 %	Spring P ppb
1992	65111	4861	69973	-1015	13854	57135	71	18	18	8.45	25	1%	0%	19
1993	121373	4861	126234	107975	114637	-96378	68	75	54	8.91	64	39%	4%	34
1994	64159	4861	69020	-109180	50861	127339	63	50	18	8.39	23	1%	0%	27
1995	98178	4861	103039	4121	30237	68681	62	24	27	8.59	33	5%	0%	27
1996	141561	4861	146422	67610	103839	-25026	68	50	41	8.65	47	24%	1%	34
1997	129885	4861	134747	-66611	83970	117388	58	41	26	8.60	33	6%	0%	29
1998	122312	4861	127173	1431	52057	73685	59	26	31	8.69	40	11%	0%	29
Mean	106083	4861	110944	619	64208	46118	63	42	31	8.61	38	13%	1%	28
Max	141561	4861	146422	107975	114637	127339	71	75	54	8.91	64	39%	4%	34
Min	64159	4861	69020	-109180	13854	-96378	58	18	18	8.39	23	1%	0%	19



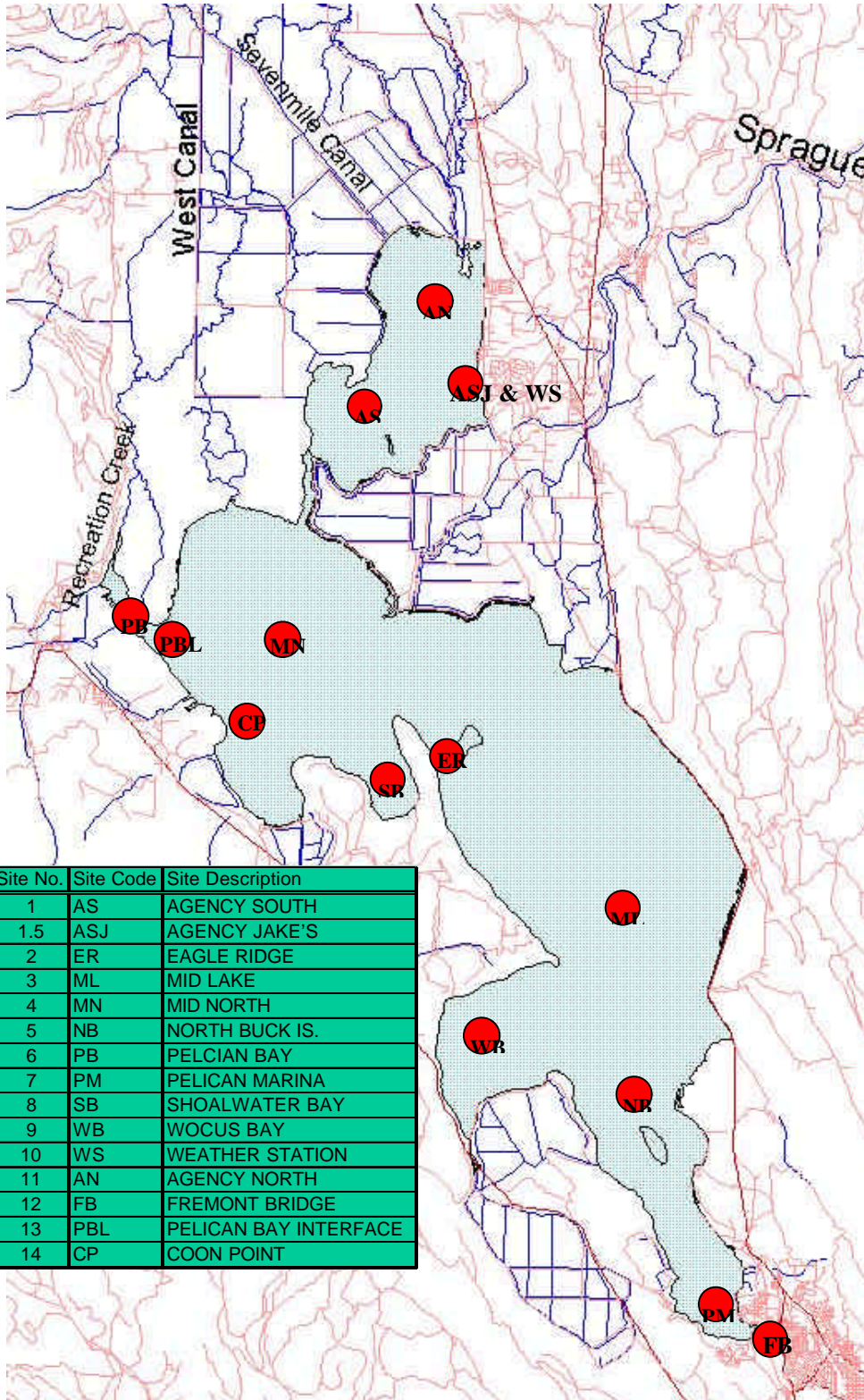
## List of Figures

- 1 Map of Watershed
- 2 Map of Sampling Stations
- 3 Seasonal Variations in Water Quality
- 4 Excursion Frequencies vs. Phosphorus - May-September
- 5 Excursion Frequencies vs. Phosphorus – June-July
- 6 Empirical Models Relating Phosphorus, Chlorophyll-a & pH
- 7 pH vs. Total P Relationships Derived from Linked Empirical Models
- 8 Phosphorus, Chlorophyll-a, and pH Time Series
- 9 pH Excursion Frequency vs. Phosphorus on Various Spatial & Temporal Scales
- 10 Trends in Phosphorus & Nitrogen Species
- 11 Model Structure
- 12 Input Hydrologic & Climatologic Time Series
- 13 Calibration of Light Extinction Model
- 14 Algal Maximum Growth & Respiration Rates vs. Temperature
- 15 Calibration of pH Model
- 16 Model Calibration Results – Linked Chl-a & pH Models
- 17 Observed & Predicted Spring Phosphorus Concentrations
- 18 Calibration of Internal Recycle Function
- 19 Biweekly Phosphorus Fluxes
- 20 Observed & Predicted Time Series Driven by Phosphorus Loads
- 21 Observed & Predicted Seasonal Variations
- 22 Factors Controlling Algal Density
- 23 Phosphorus, Chlorophyll-a, & pH Simulations
- 24 Excursion Frequencies vs. Phosphorus Load Reduction
- 25 pH Simulations with Estimated Background Loads
- 26 Apparent Trends in Inflow and Lake Spring P Concentrations
- 27 Spring P & Summer pH Excursion Frequency vs. Inflow P Concentration

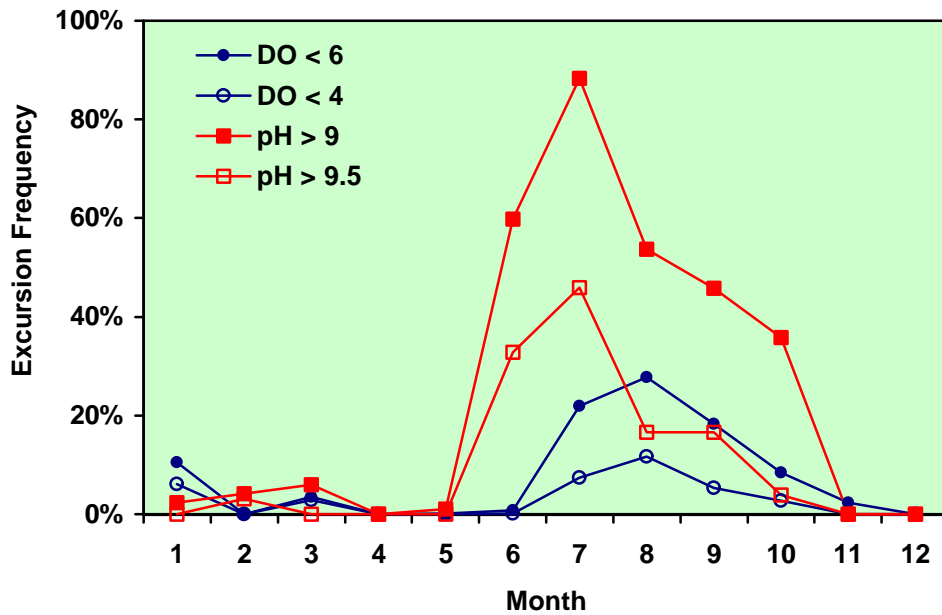
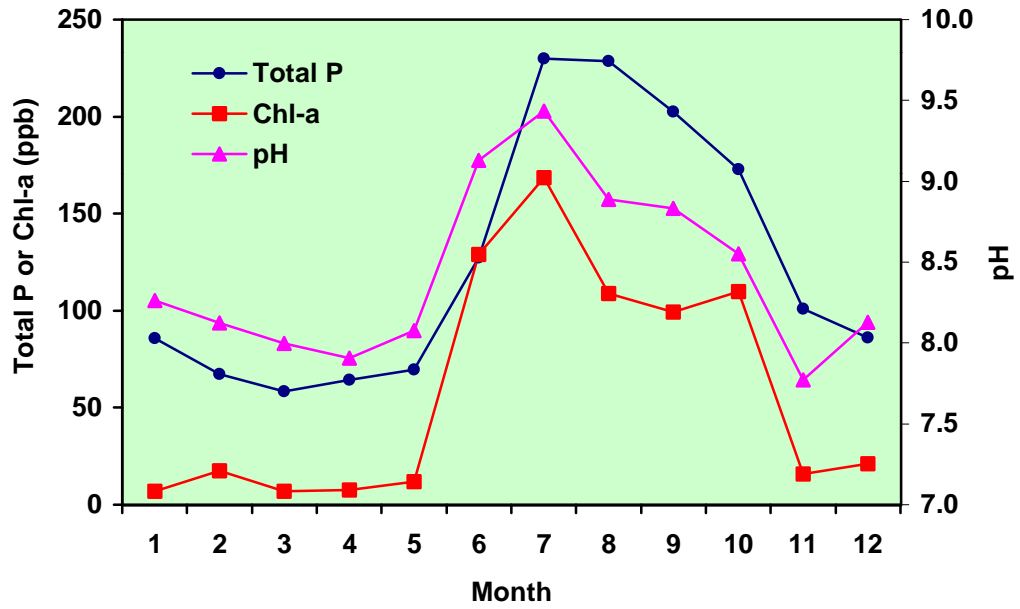
**Figure 1**  
**Map of Watershed**



**Figure 2**  
**Map of Sampling Stations**

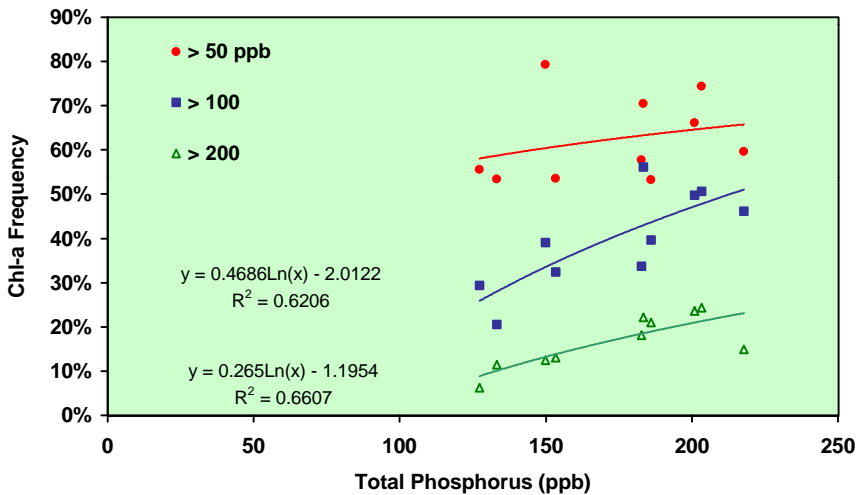
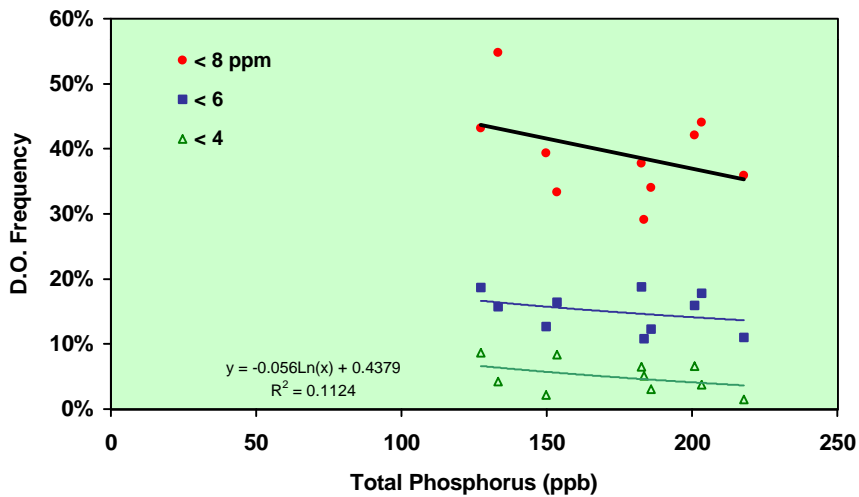
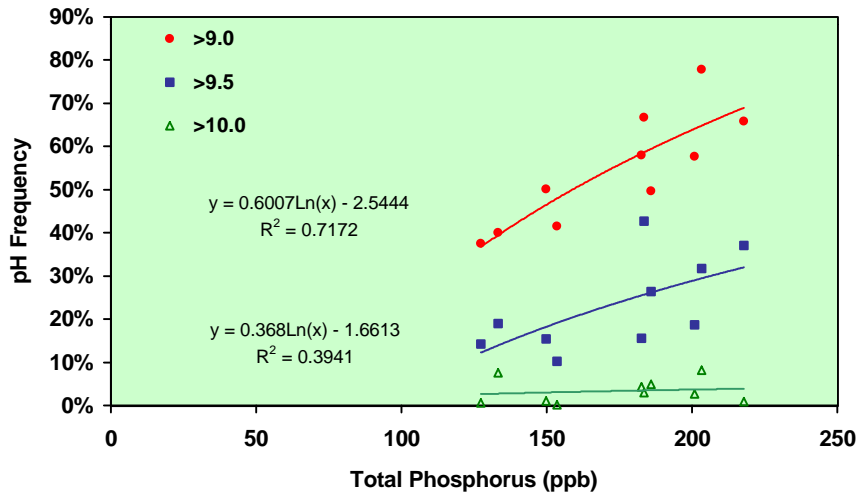


**Figure 3**  
**Seasonal Variations in Water Quality**



**Figure 4**  
**Excursion Frequencies vs. Total Phosphorus**

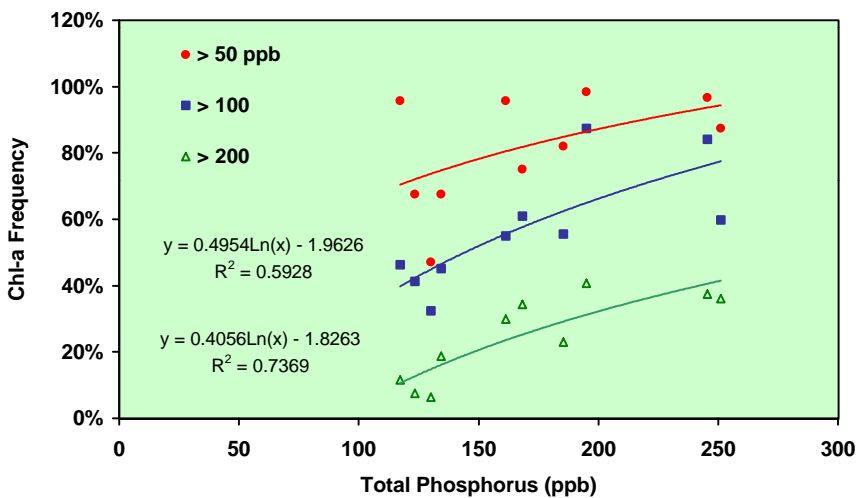
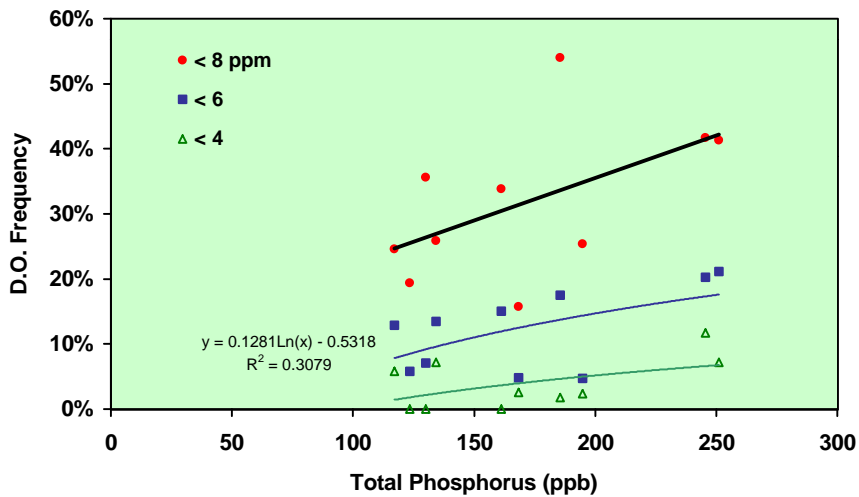
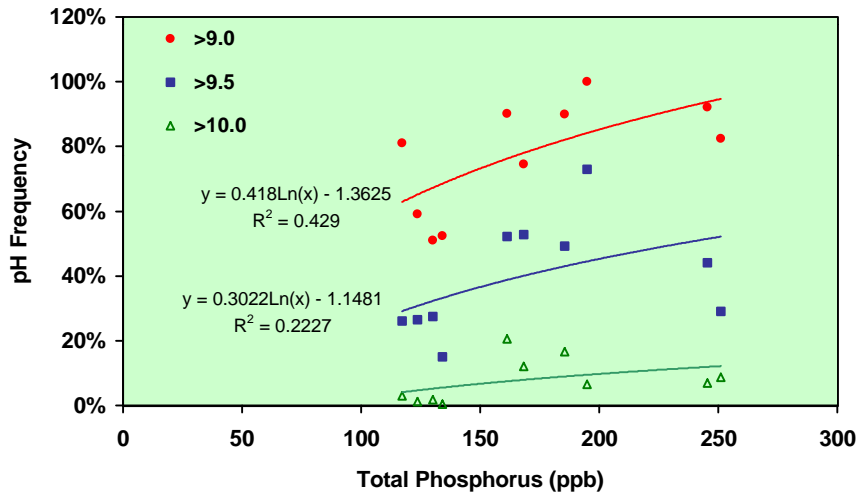
Months: 5 thru 9



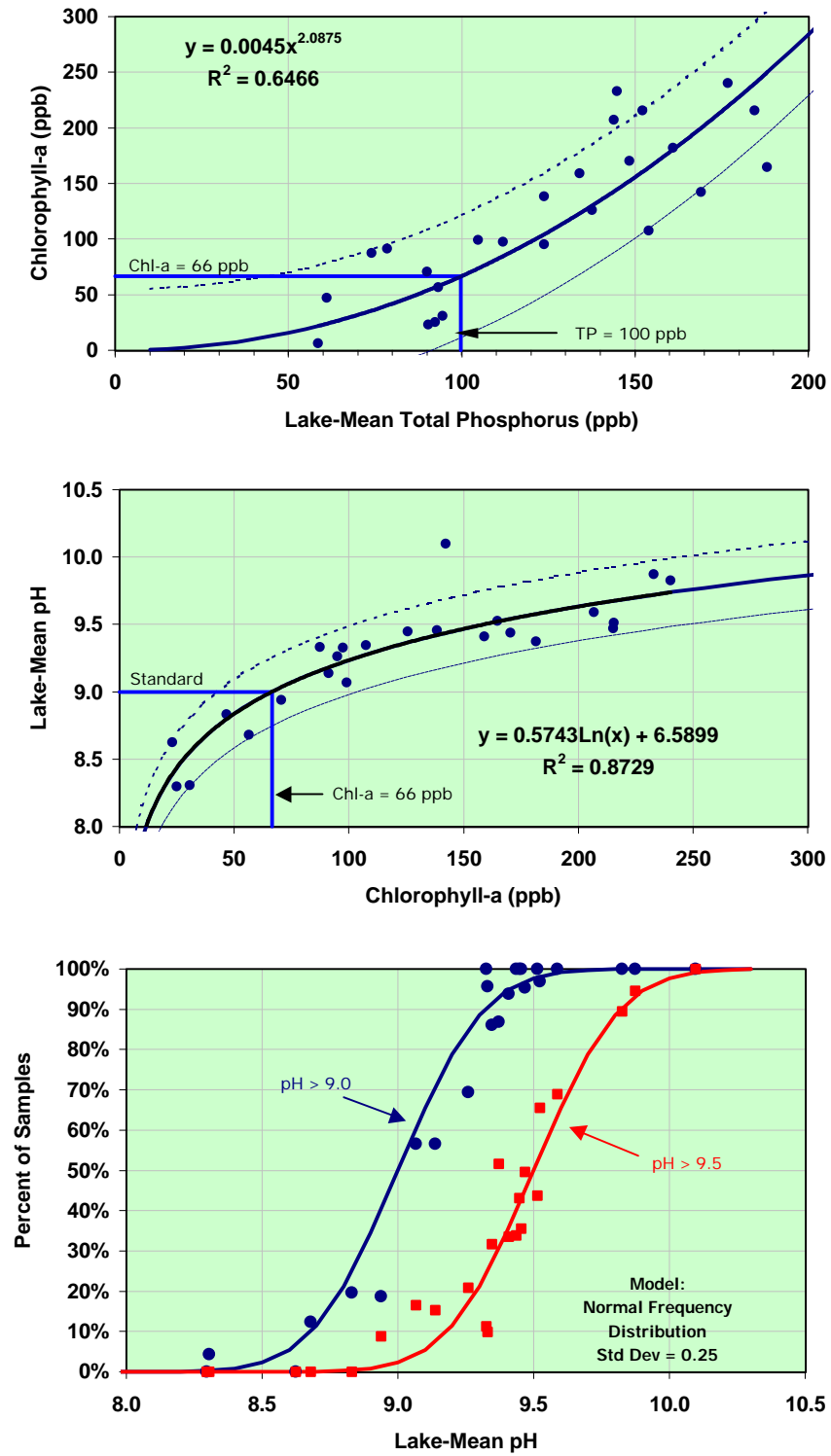
**Figure 5**  
**Excursion Frequencies vs. Total Phosphorus**

Months:

6 thru 7

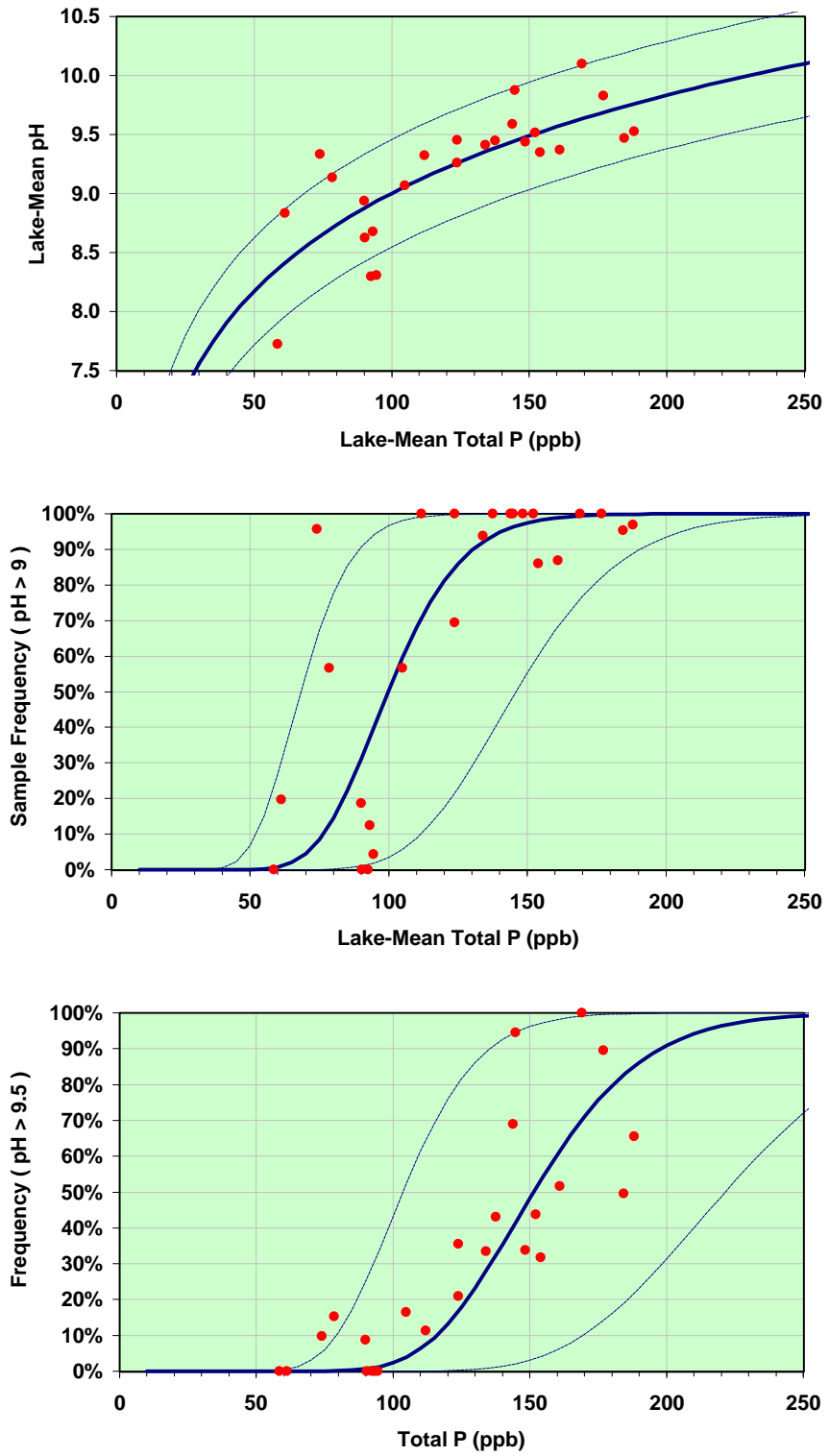


**Figure 6**  
**Empirical Models Relating Phosphorus, Chlorophyll-a & pH**



Symbols: Mean Values for June & July Sampling Dates, 1990-1999, Total P < 190 ppb  
 Dashed Lines Show ~80% Prediction Intervals for Individual Sampling Dates

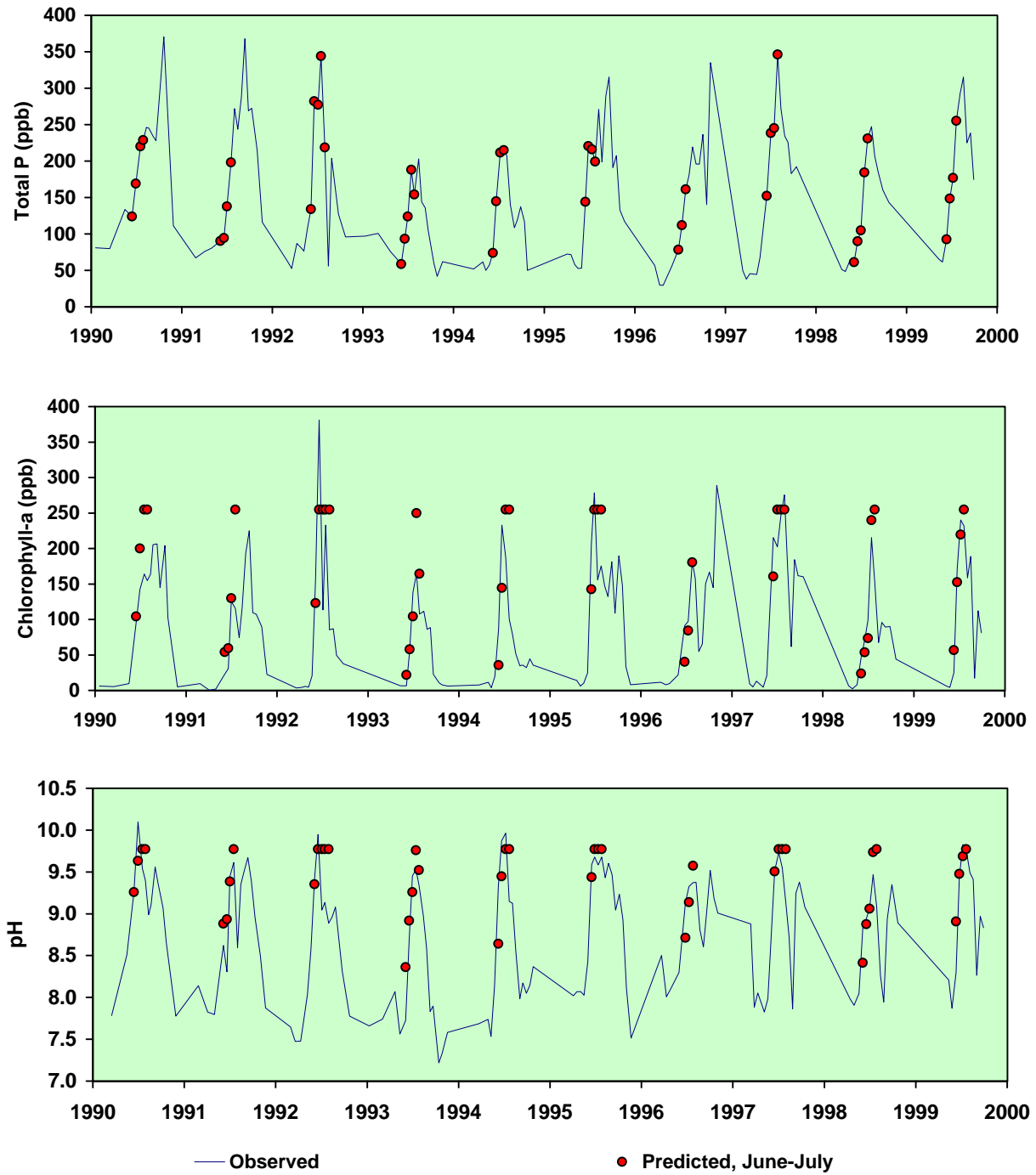
**Figure 7**  
**pH vs. Total P Relationships Derived from Linked Empirical Models**



Symbols: Mean Values for June & July Sampling Dates, 1990-1999, Total P < 190 ppb  
 Dashed Lines Show ~80% Prediction Intervals for Individual Sampling Dates



**Figure 8**  
**Phosphorus, Chlorophyll-a, & pH Time Series**

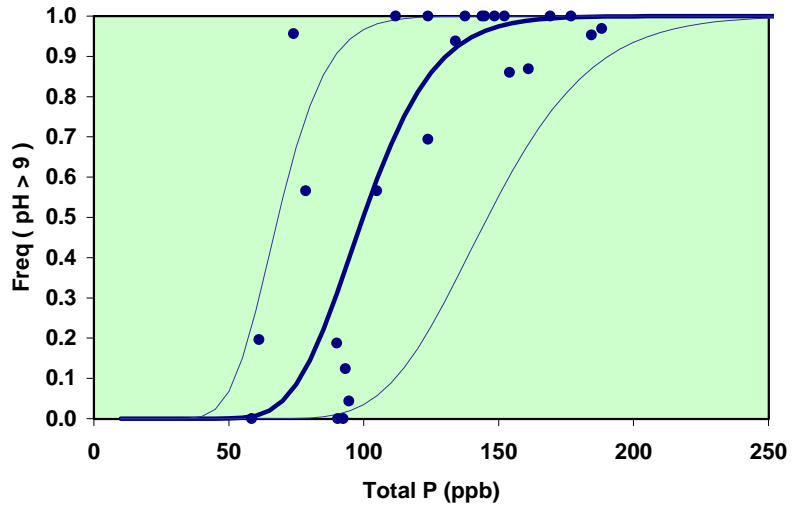


Lake Mean Concentrations; lines = Observed; Symbols = June-July Observed Total P, Predicted Chlorophyll-a, & Predicted pH

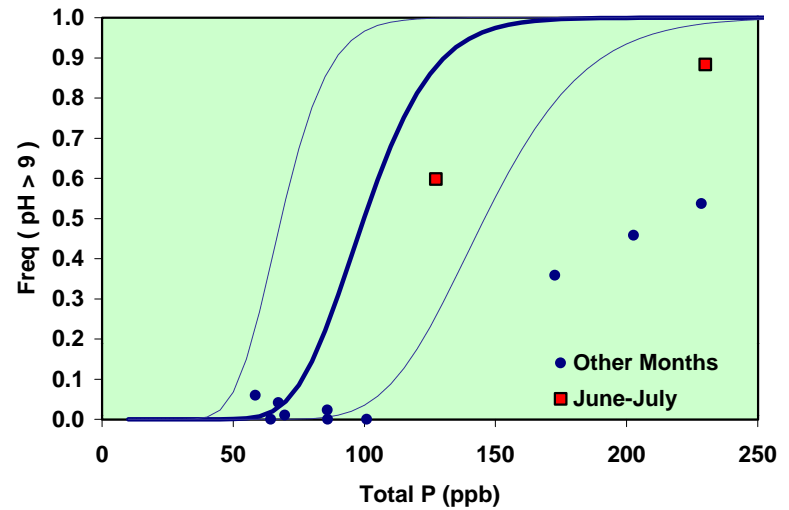
## Figure 9

### pH Excursion Frequency vs. Total Phosphorus on Variations Spatial & Temporal Scales

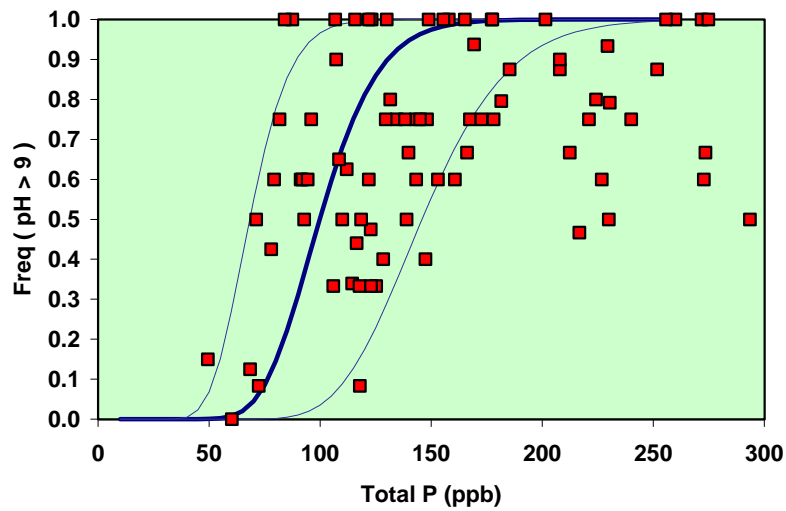
Lake Means by Sampling Event (June+July), Calibration:



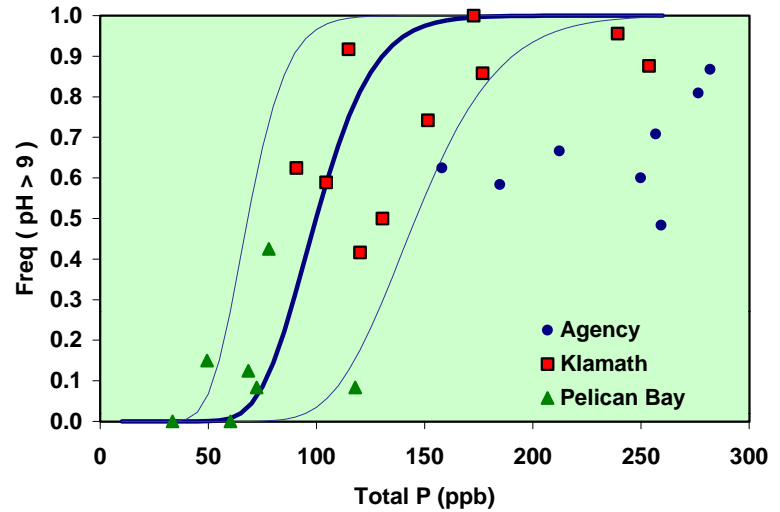
Lake Means by Month:



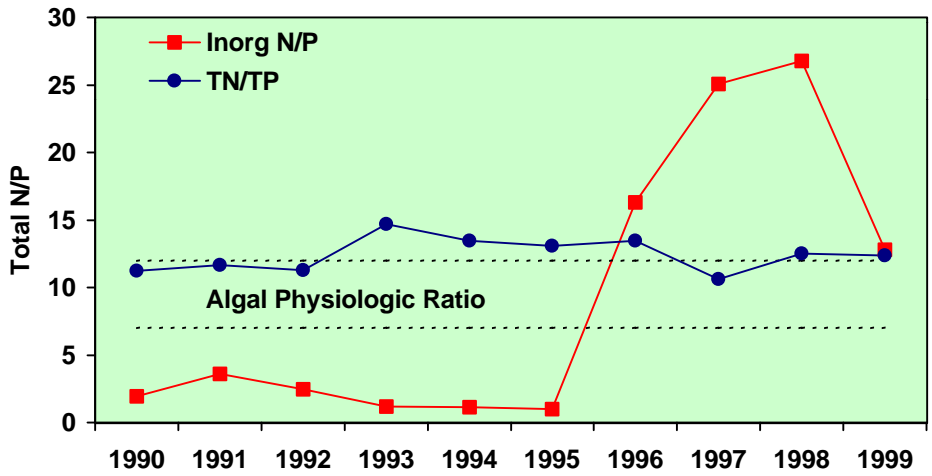
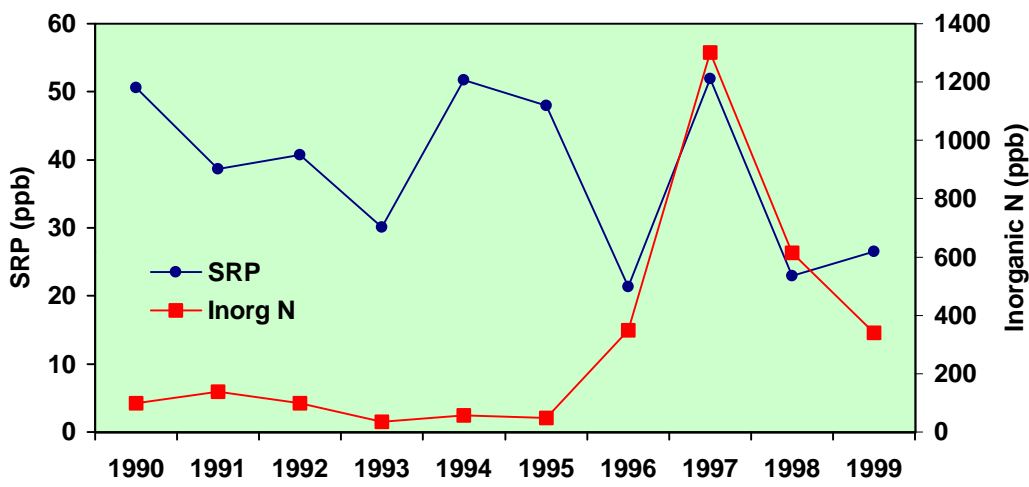
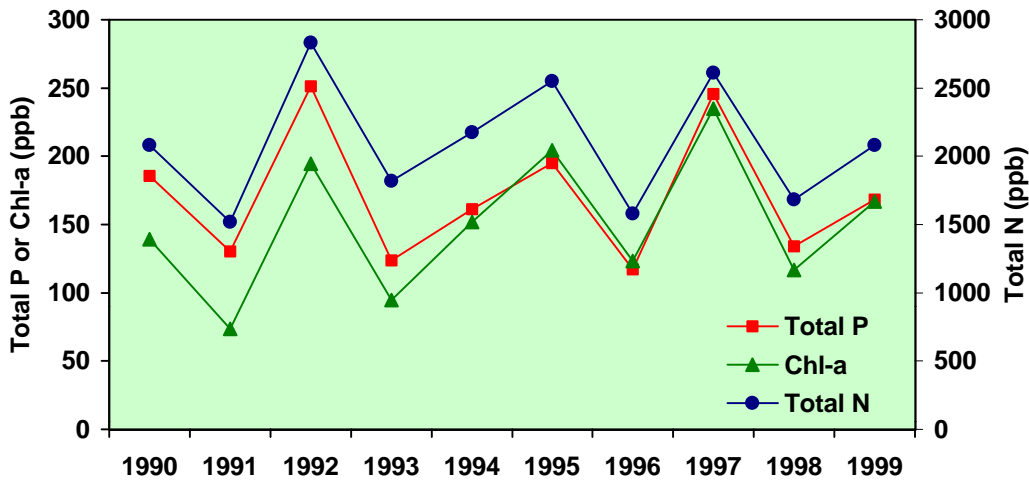
Site Means by Year (June+July):



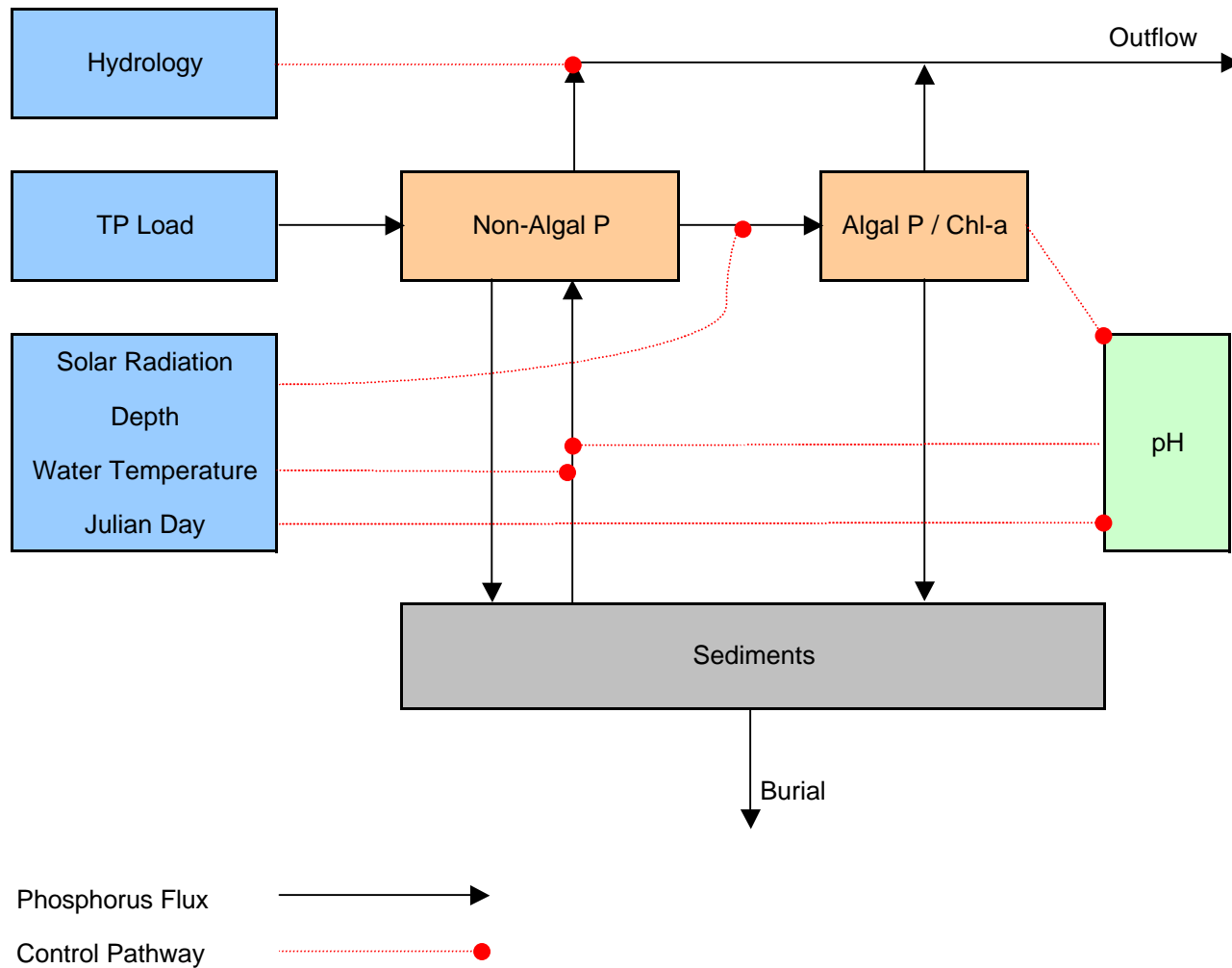
Lake Regional Means by Year (June+July):



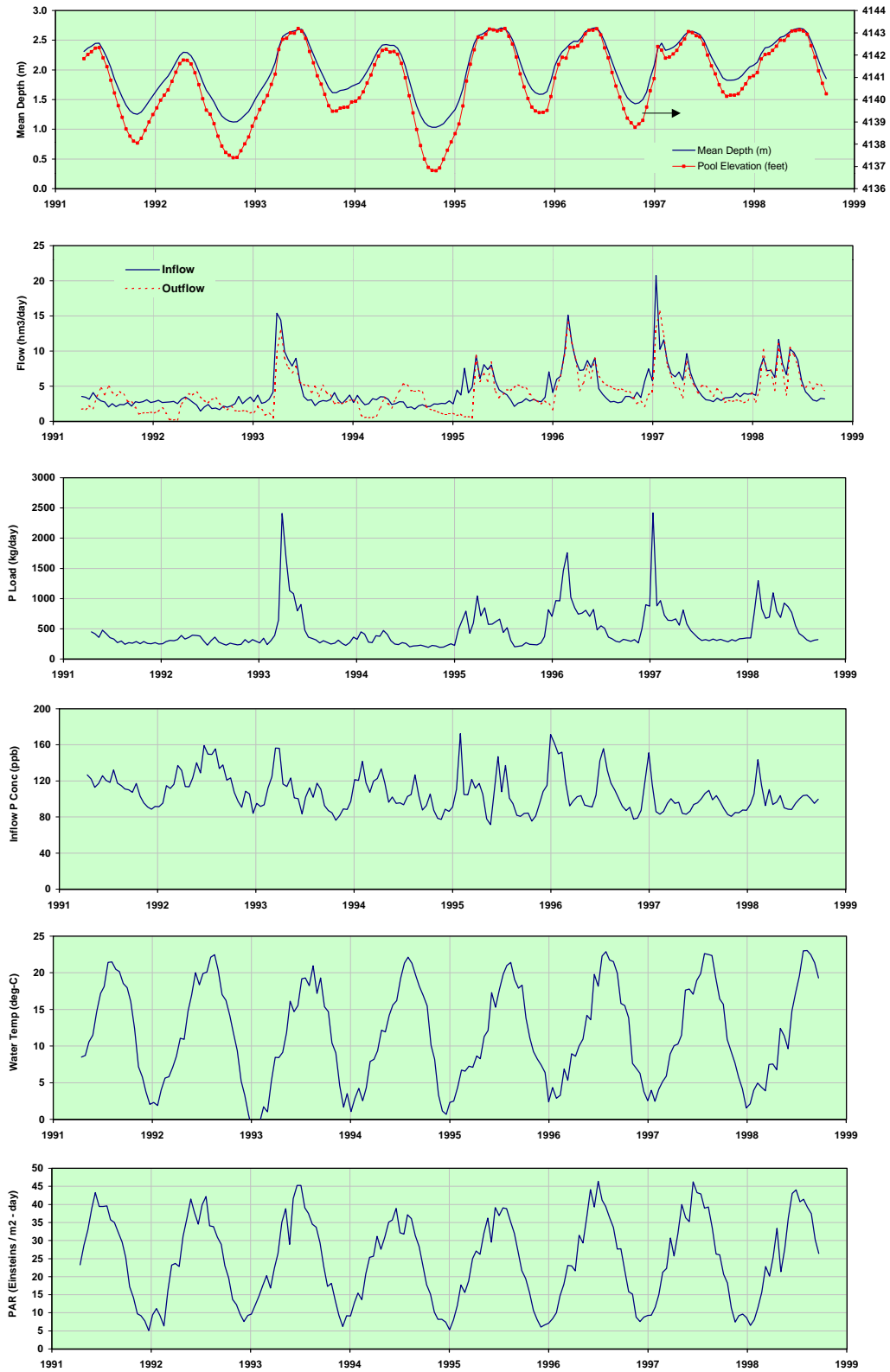
**Figure 10**  
**Trends in Phosphorus & Nitrogen Species**



**Figure 11**  
**Model Structure**

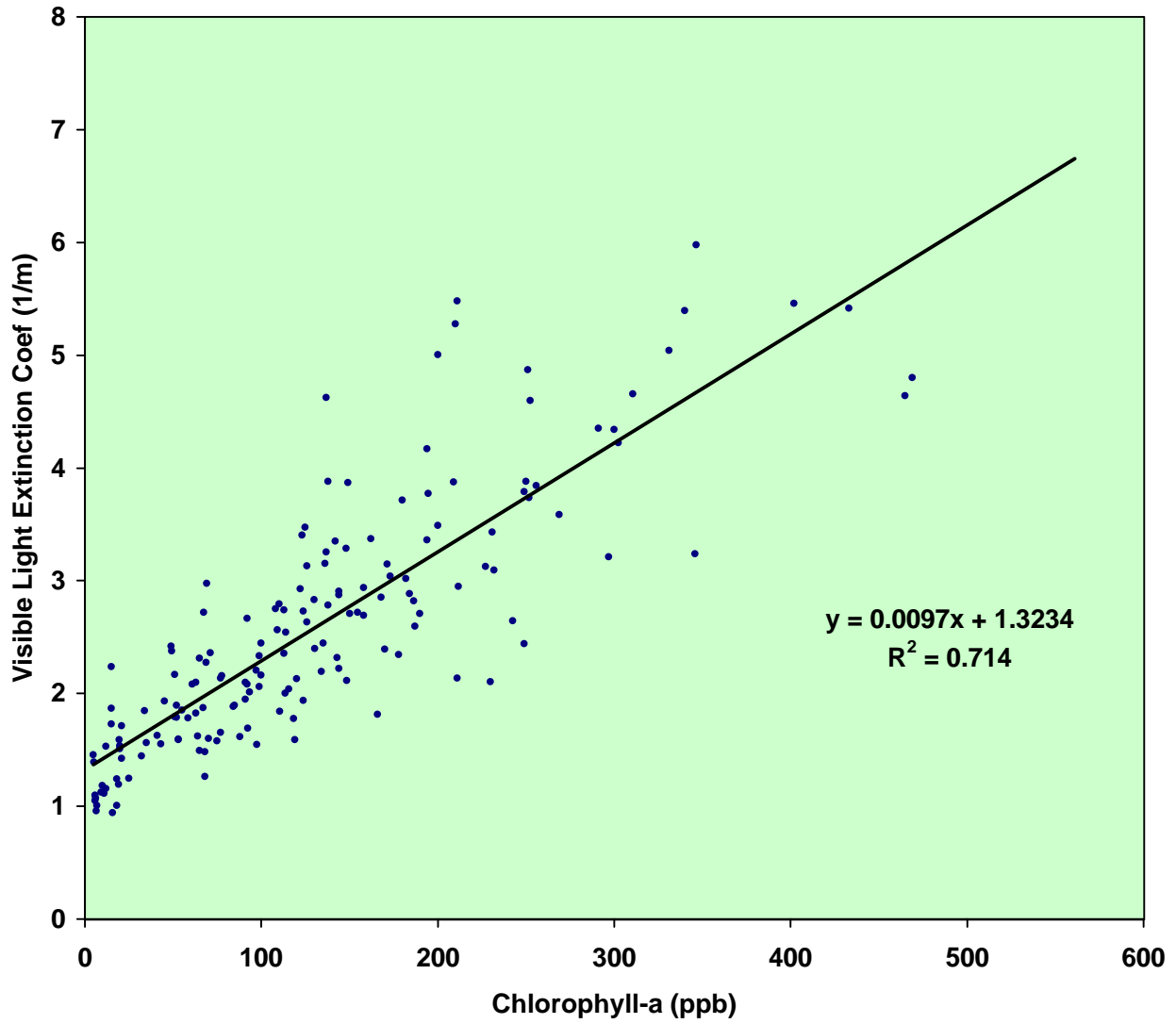


**Figure 12**  
**Input Hydrologic & Climatic Time Series**



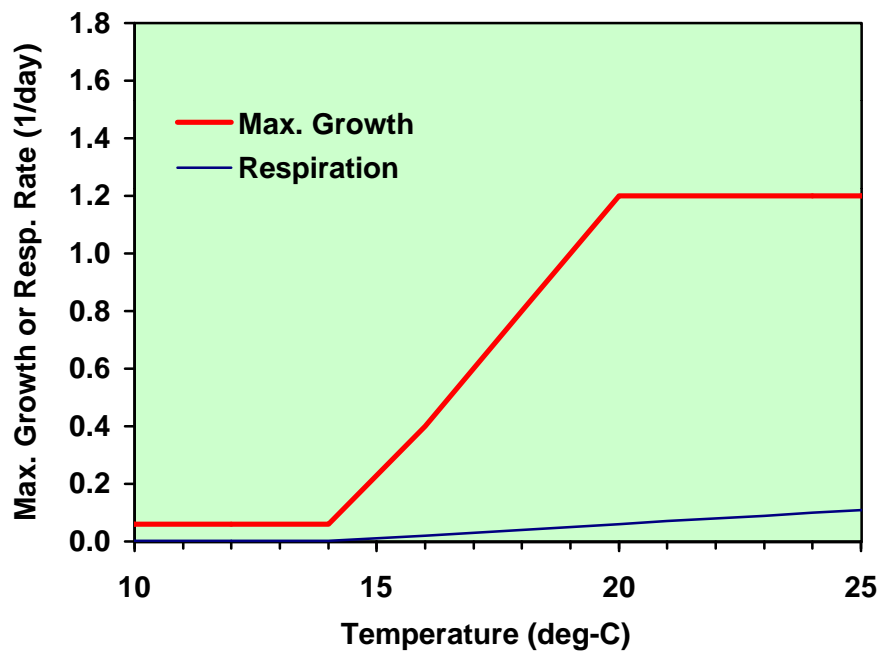
Biweekly Averages

**Figure 13**  
**Calibration of Light Extinction Model**

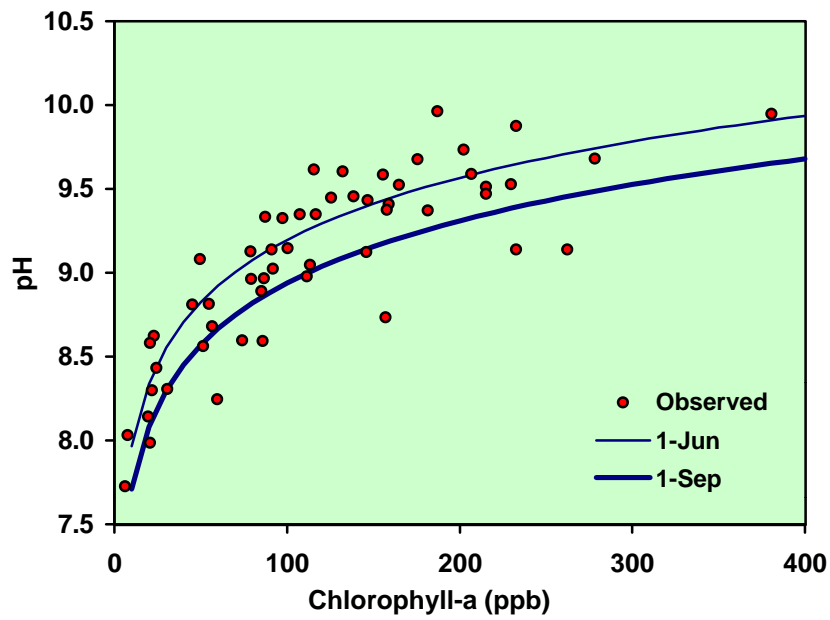
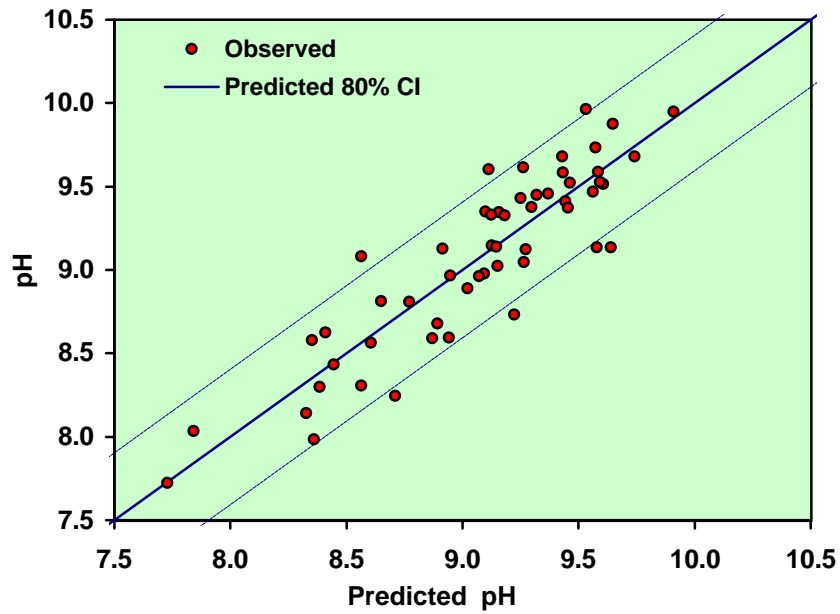


Data: Paired Light & Chlorophyll-a Measurements at Individual Stations  
June-July, 1990-1999 One outlier removed

**Figure 14**  
**Algal Maximum Growth & Respiration Rates vs. Temperature**



**Figure 15**  
**Calibration of pH Model**



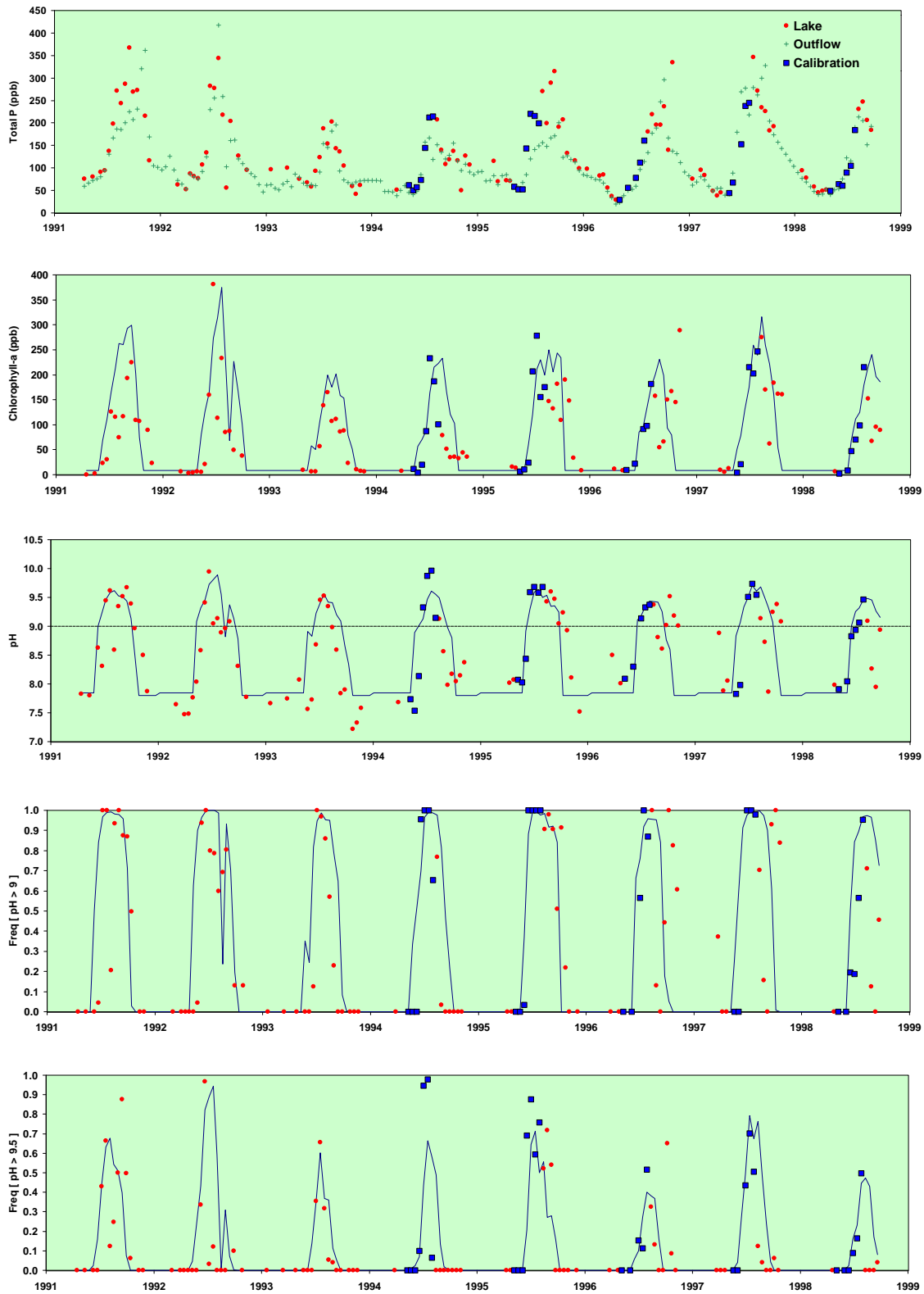
$$Y = a + b \ln(\text{Chl-a}) + c [\text{Max}(\text{Julian Day}, 200)]$$

a =	7.9310	R <sup>2</sup> =	0.803
b =	0.5338	SE =	0.242
c =	-0.0060		

Calibration Months: June-August

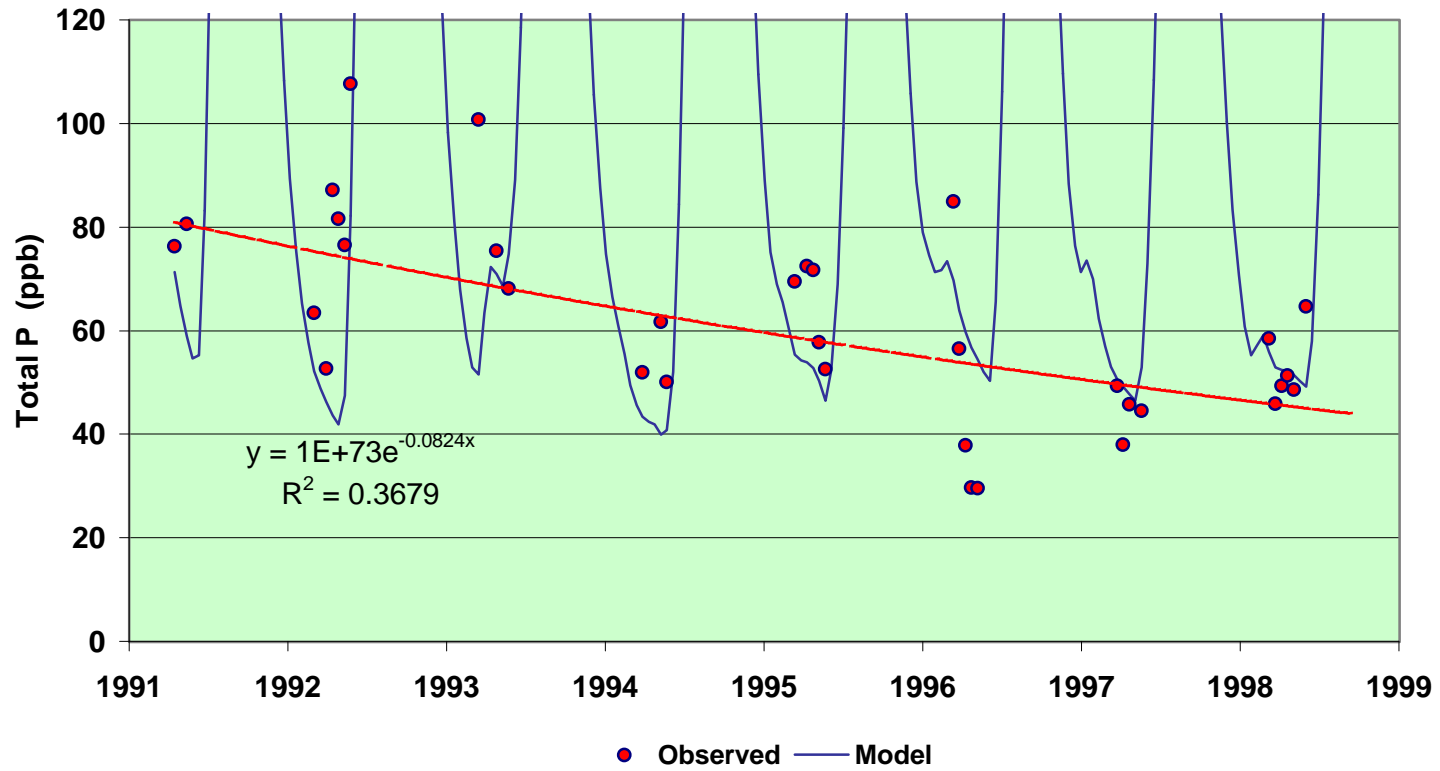


**Figure 16**  
**Observed & Predicted Time Series - Linked Chl-a & pH Models**



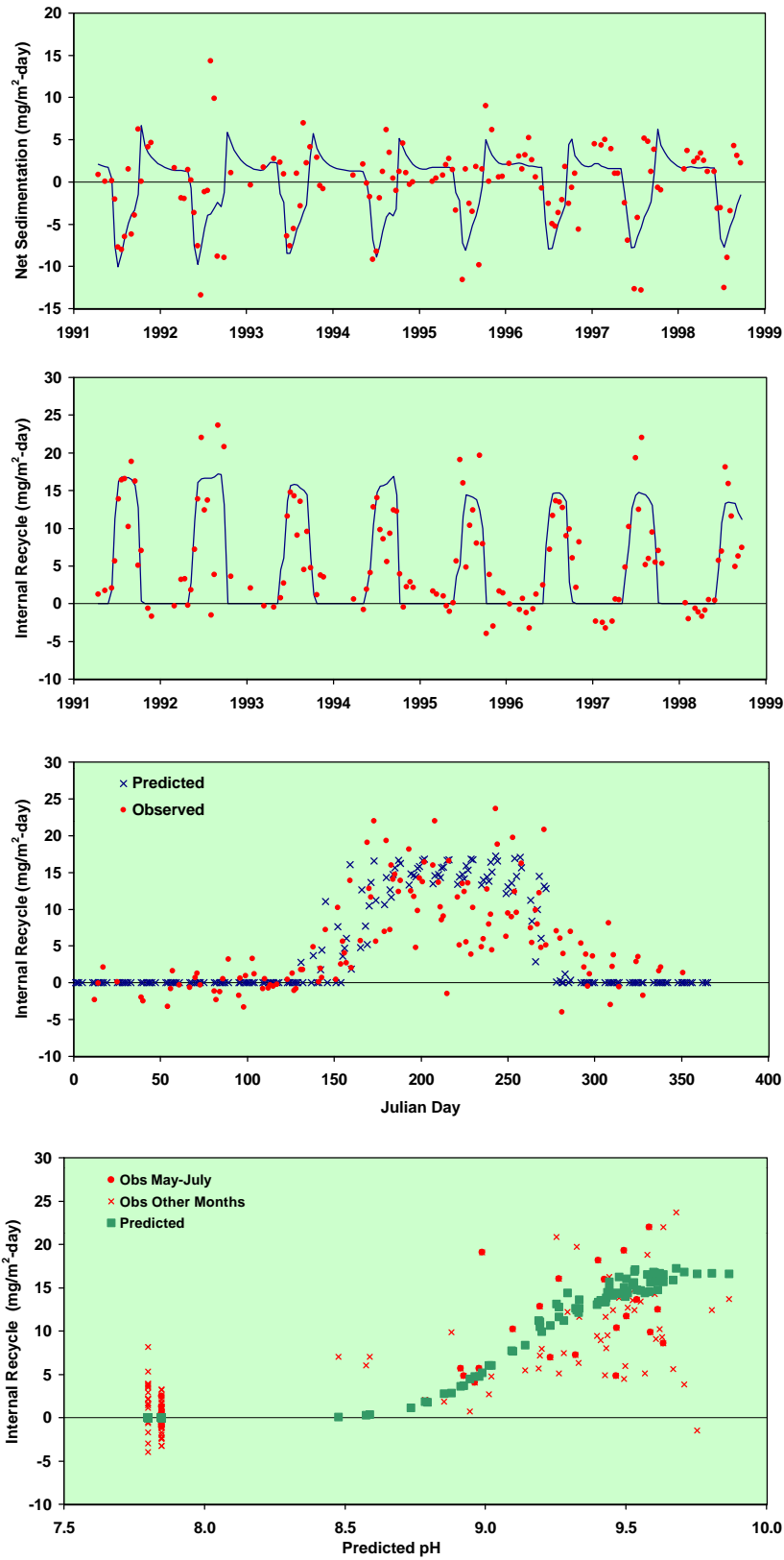
Top: Observed Lake P & Outlet P concentrations  
 Lines: Chl-a, pH, & pH Frequency predicted from observed Total P & other factors regulating chlorophyll-a & pH (light, temp., depth, flushing, etc.)  
 Squares: Observed values used for model calibration (May-July, 1994-1999)  
 Circles: Observed values used for model testing

Figure 17  
Observed & Predicted Spring Phosphorus Concentrations



Months: 3 thru 5

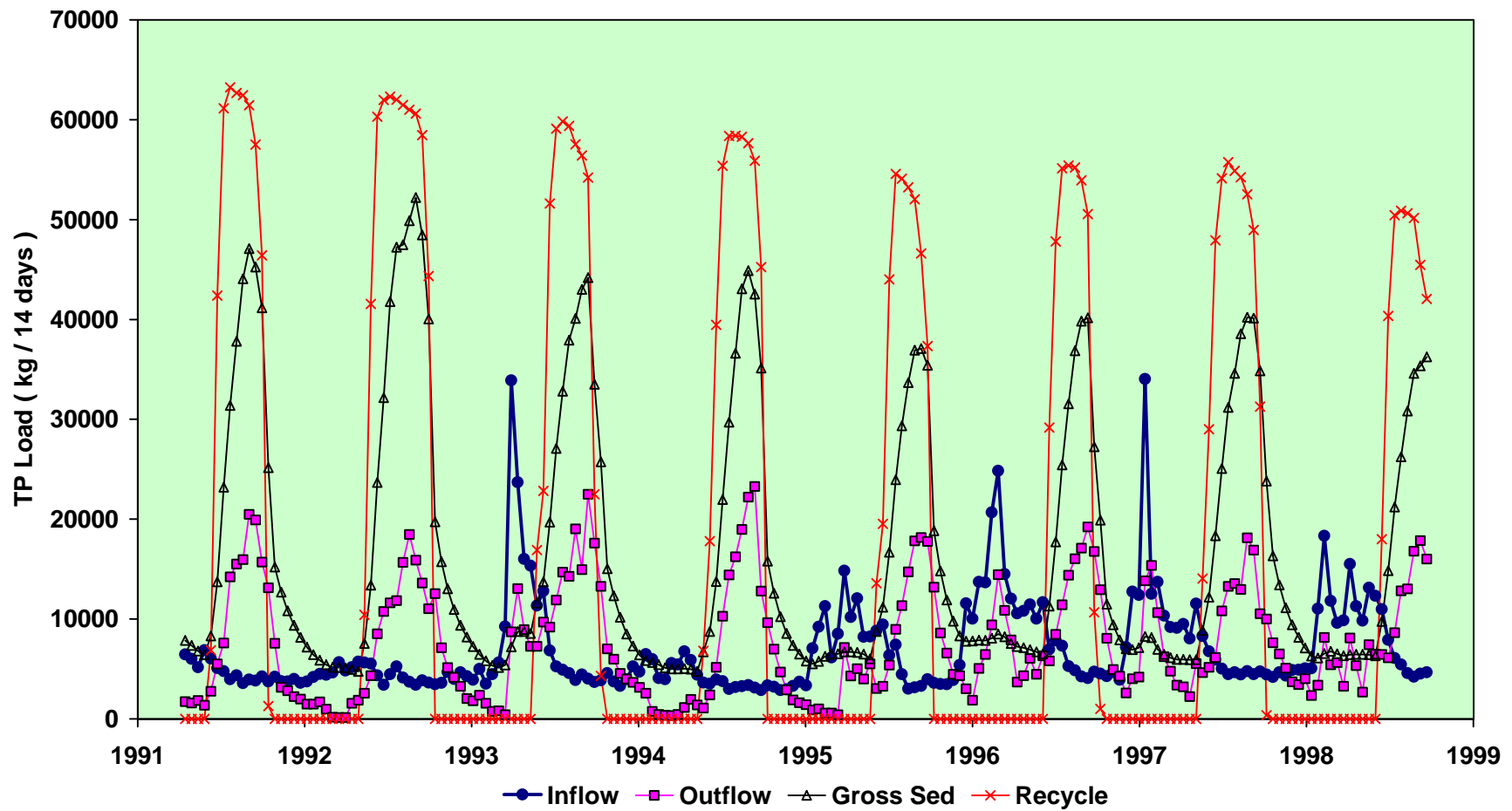
**Figure 18**  
**Calibration of Internal Recycle Function**



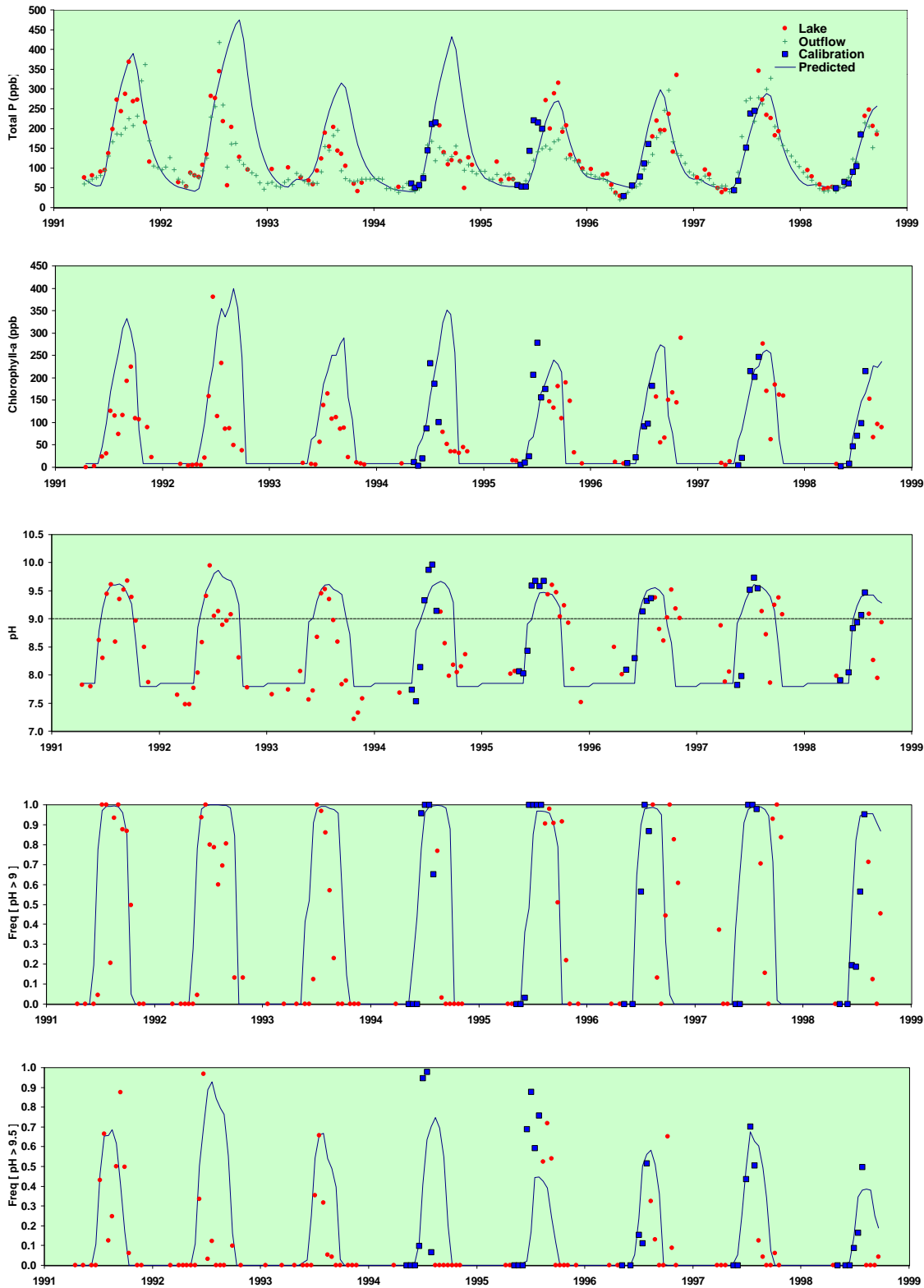
Observed Internal Load = Predicted Gross Sedimentation - Observed Net Sedimentation

Predicted recycle rates (squares, bottom panel) vary with pH because they are also dependent on sediment P content

Figure 19  
Biweekly Phosphorus Fluxes

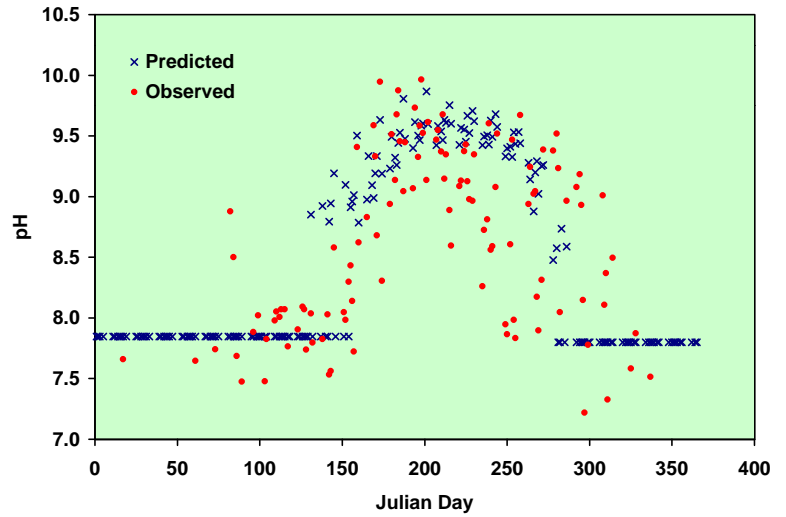
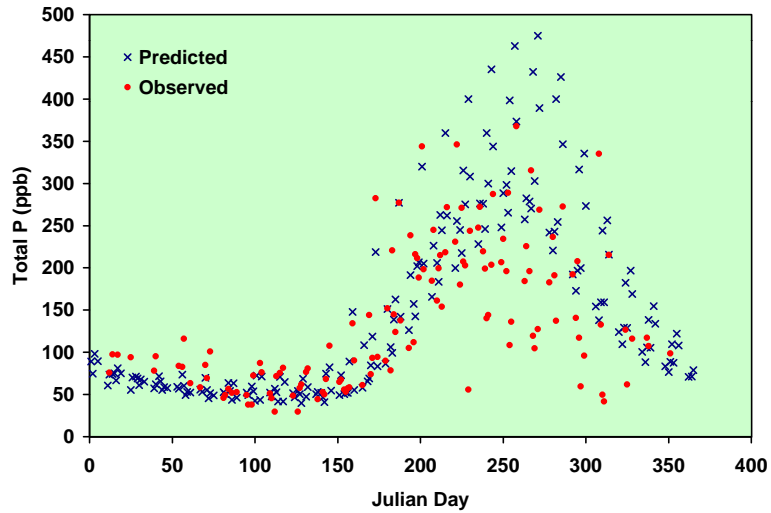
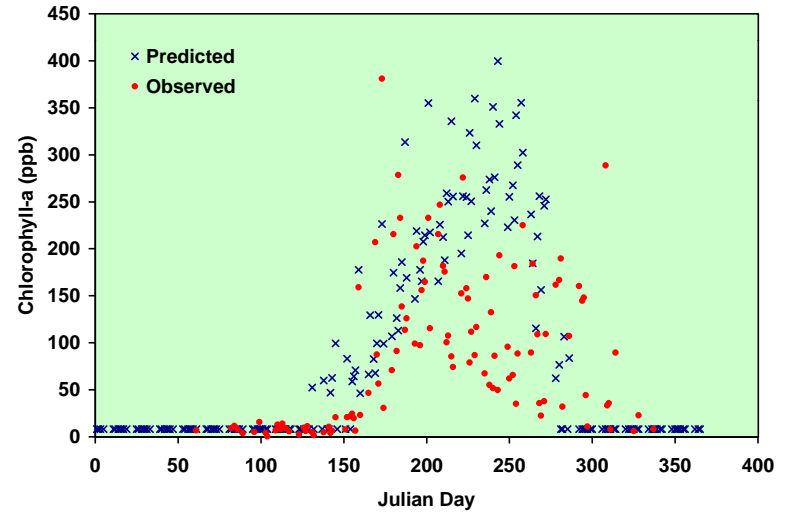
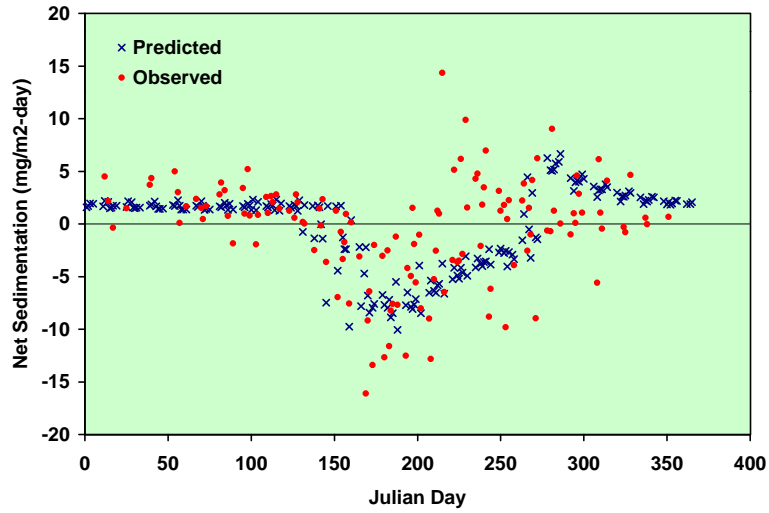


**Figure 20**  
**Observed & Predicted Time Series Driven by Phosphorus Loads**

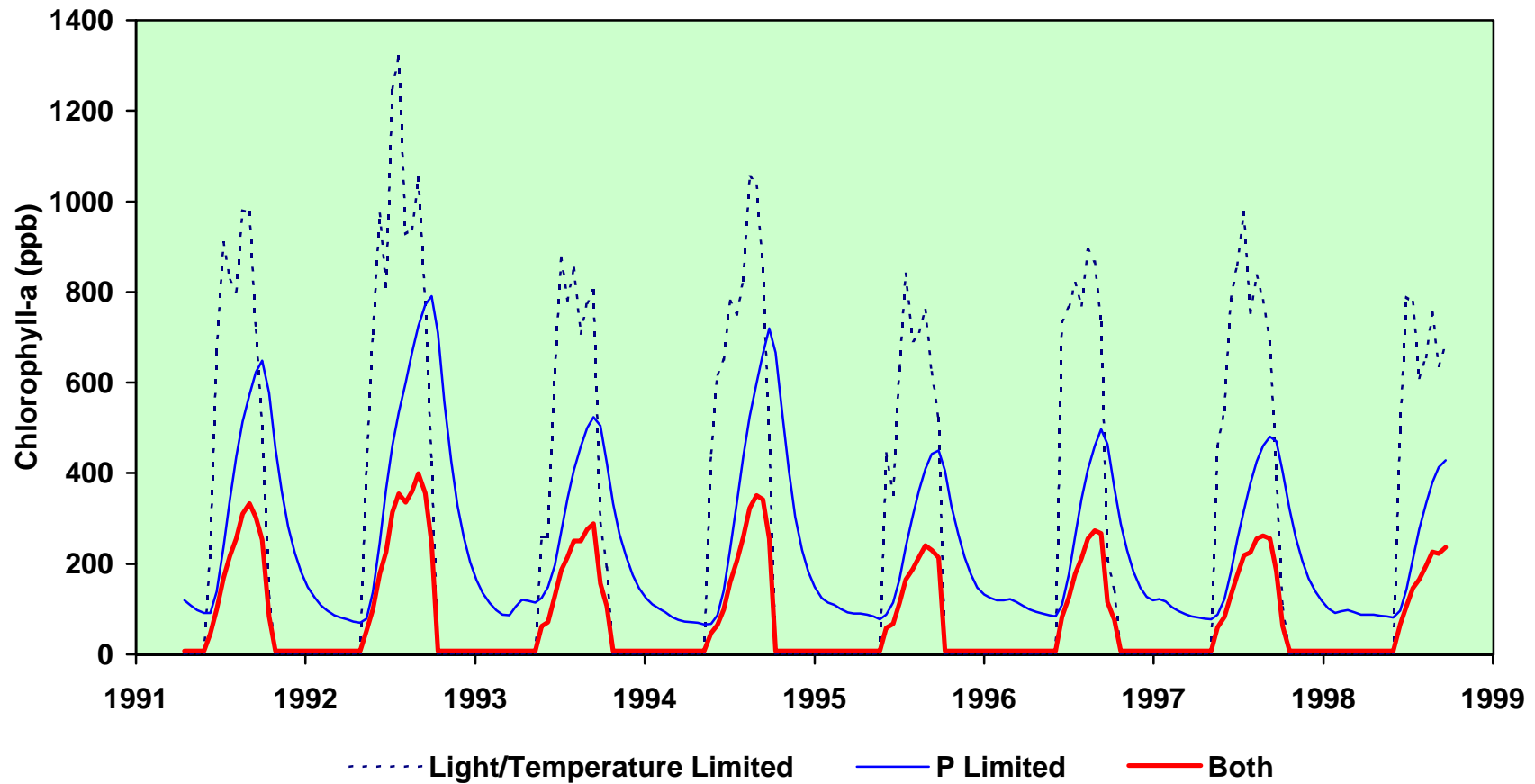


Top: Observed Lake P & Outlet P concentrations  
 Lines: TP, Chl-a, pH, & pH Frequency predicted from external P loads & other controlling factors (light, temp., depth, flushing, etc.)  
 Squares: Observed values used for model calibration (May-July, 1994-1999)  
 Circles: Observed values used for model testing

Figure 21  
Observed & Predicted Seasonal Variations



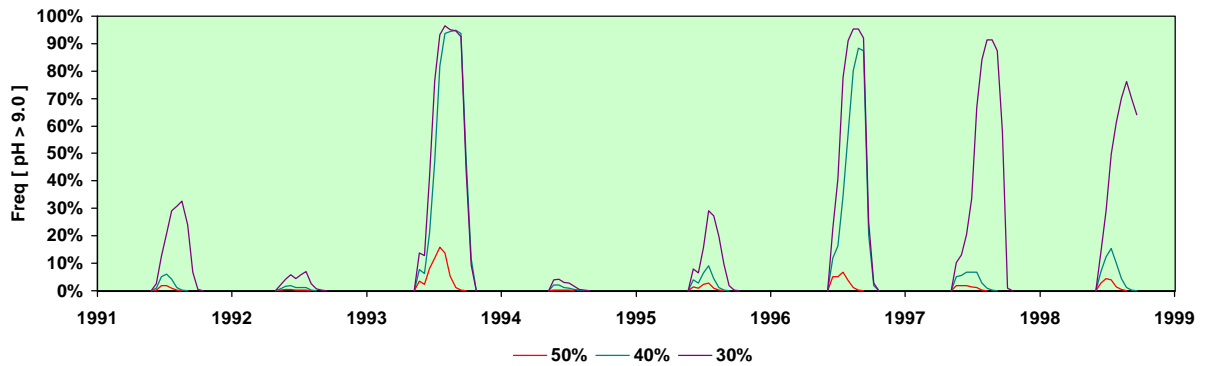
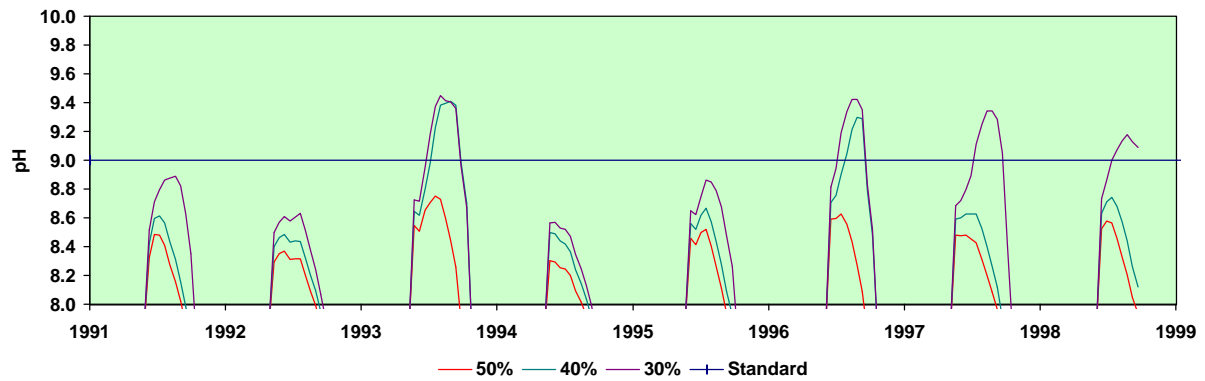
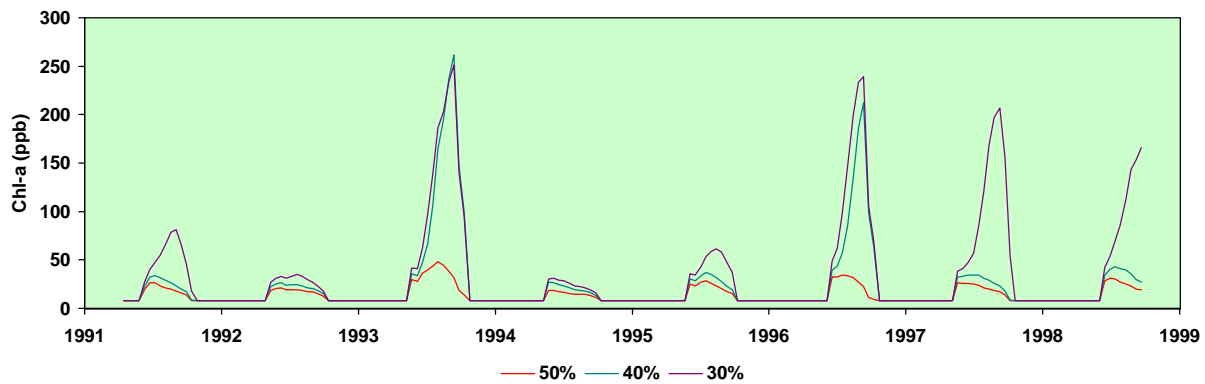
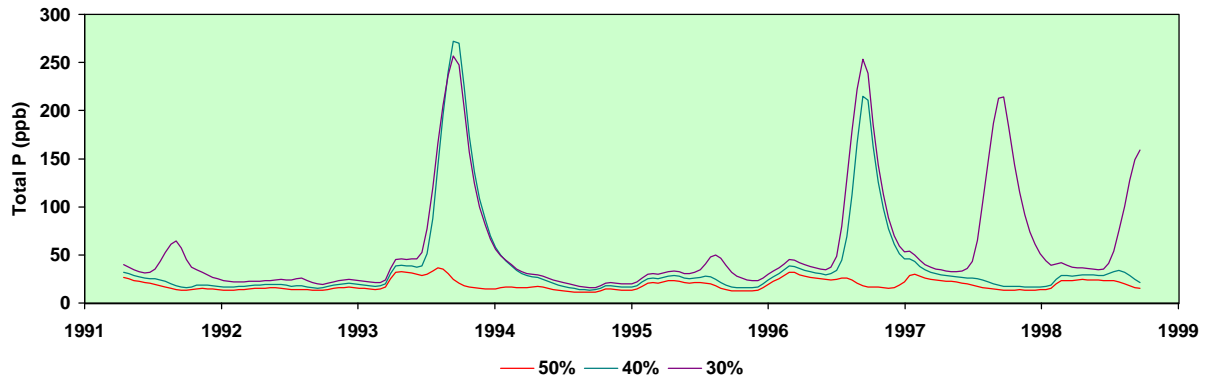
**Figure 22**  
**Factors Controlling Algal Density**



Light/Temperature Limited =  
P Limited =  
Both =

Predicted Chl-a with Infinite P Concentration at Ambient Temperature & Light  
Predicted Chl-a with Optimal Light Intensity & Temperature at Ambient P Concentration  
Predicted Chl-a Considering All Factors

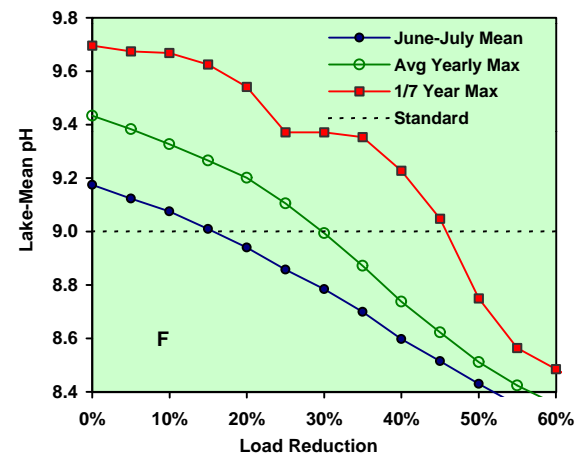
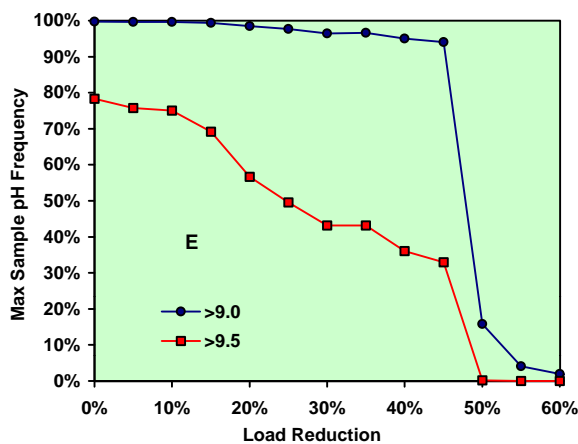
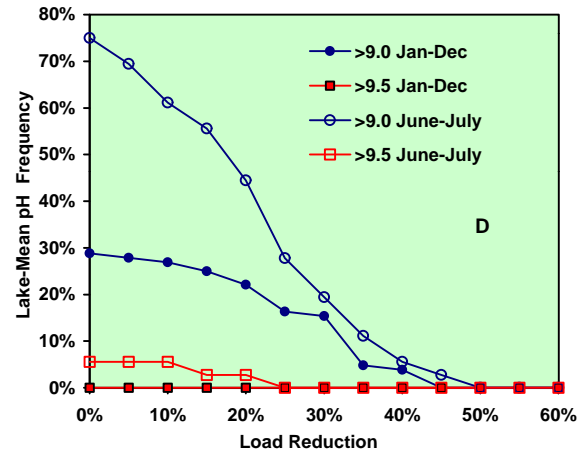
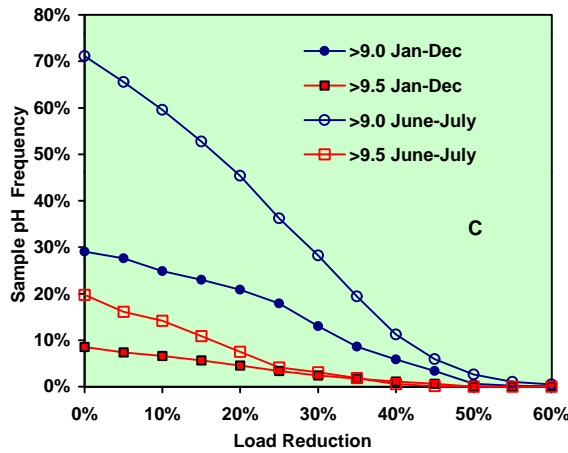
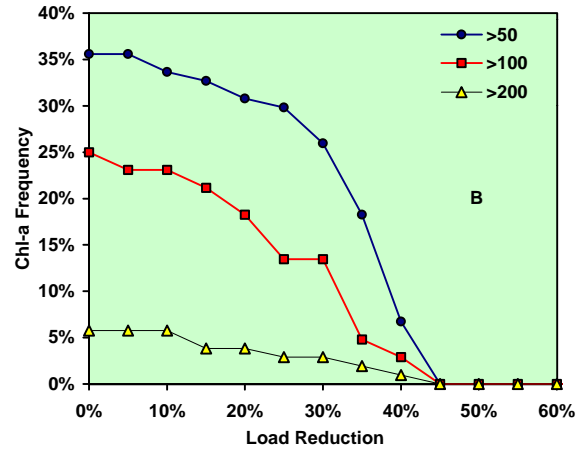
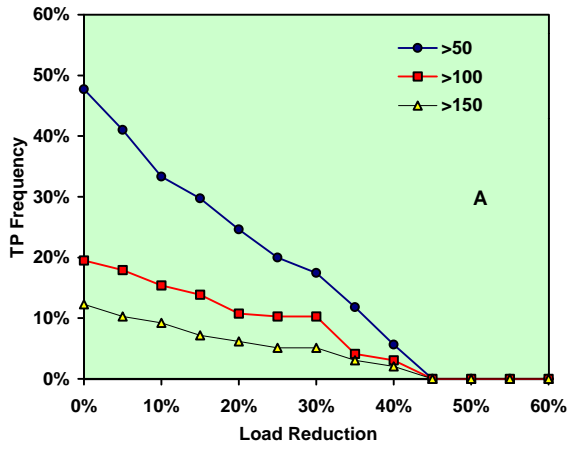
**Figure 23**  
**Phosphorus, Chlorophyll-a, & pH Simulations**



Curve Labels = Percent Reduction in Historical P Load



**Figure 24**  
**Excursion Frequencies vs. Phosphorus Load Reduction**



A,B: Total P & Chl-a Frequencies for January-December, Averaged over 7 Years

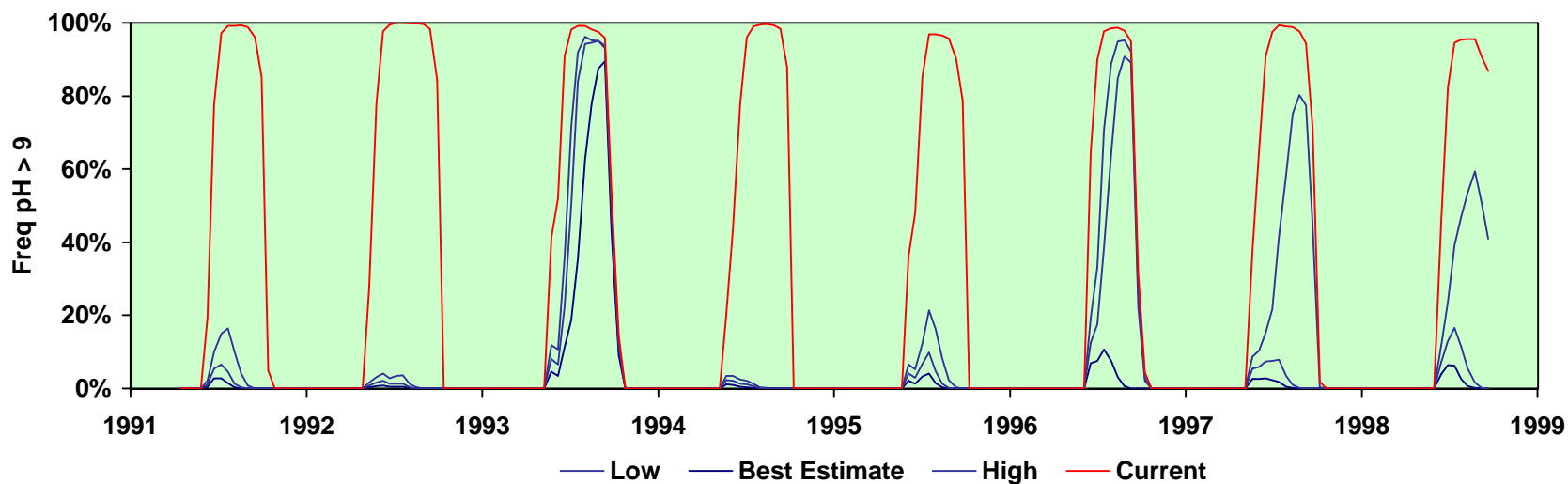
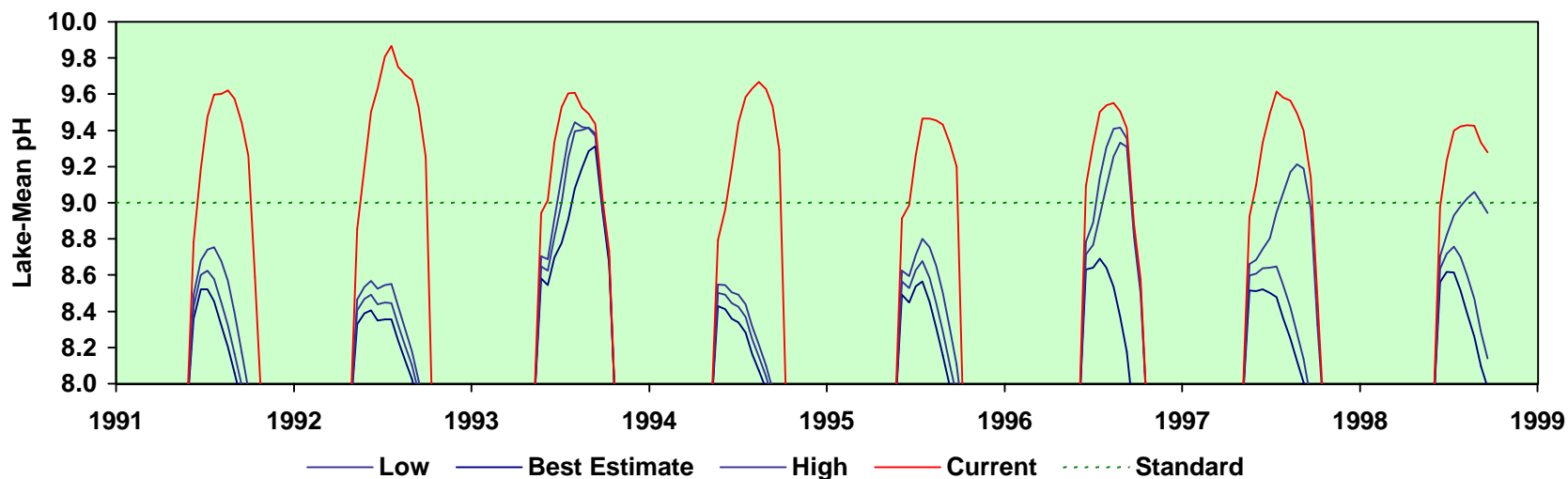
C: % of pH Measurements, Averaged Over 7 Years, For Jan-Dec & June-July

D: % of Lake-Mean pH Values, Averaged Over 7 Years, For Jan-Dec & June-July

E: Maximum% of Measurements in Any 2-Week Period, All Seasons & Years (i.e., worst-case)

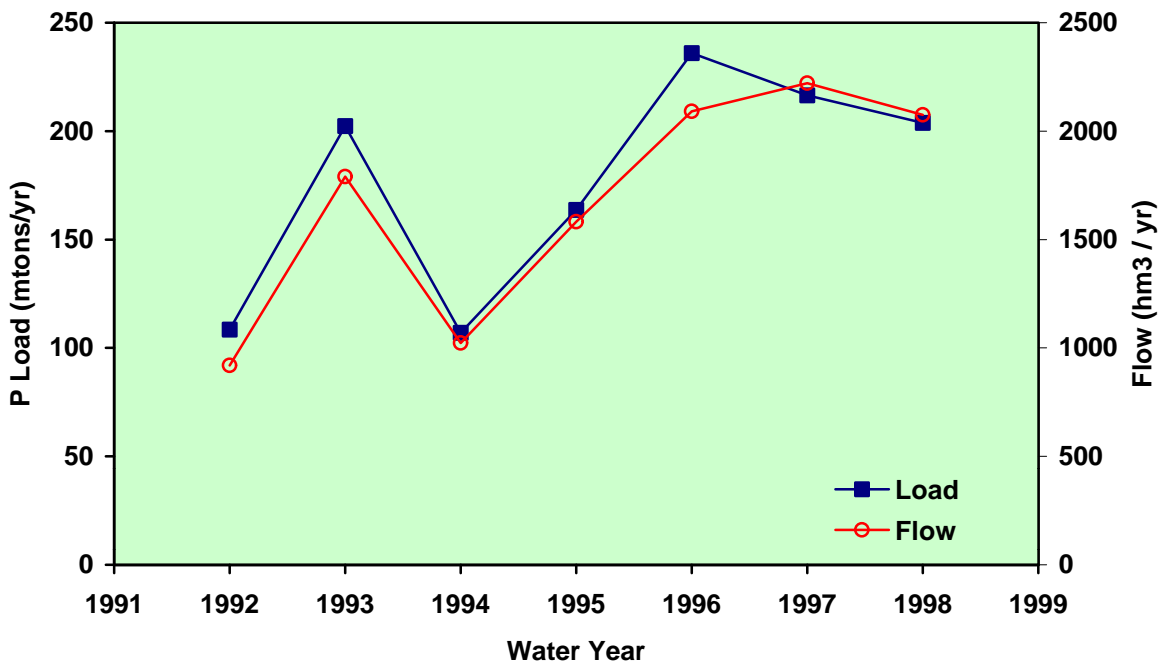
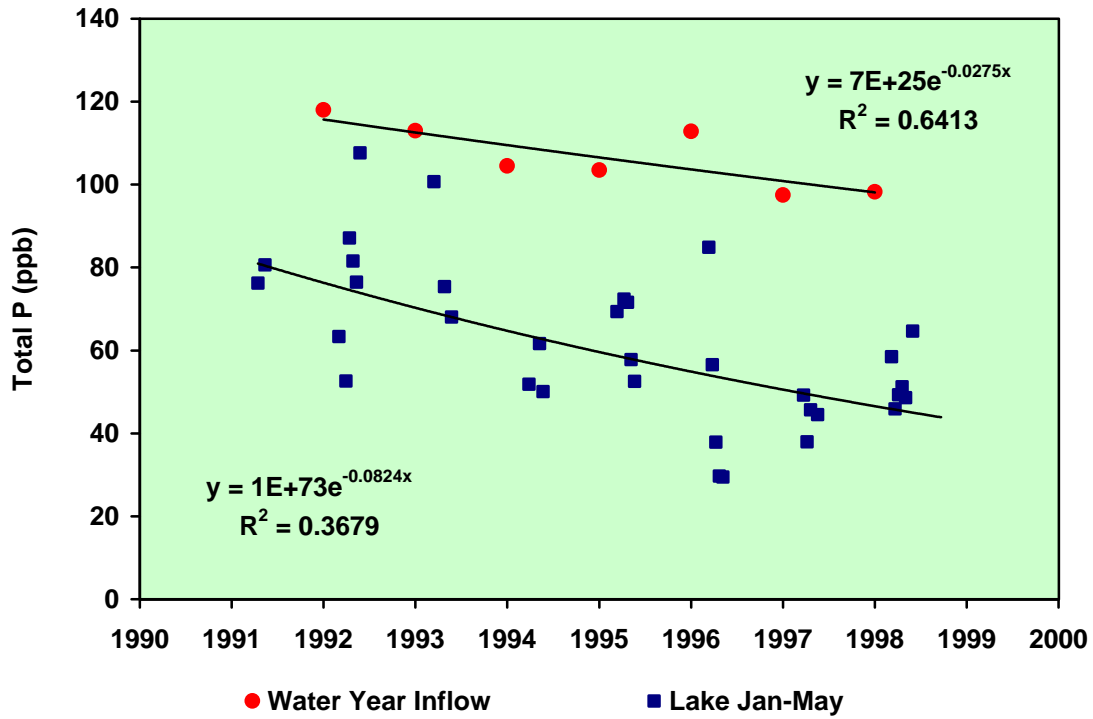
F: Lake Mean pH for June-July (Mean, Mean Yearly Maximum, 1/7 Year Maximum)

**Figure 25**  
**pH Simulations with Estimated Background Loads**

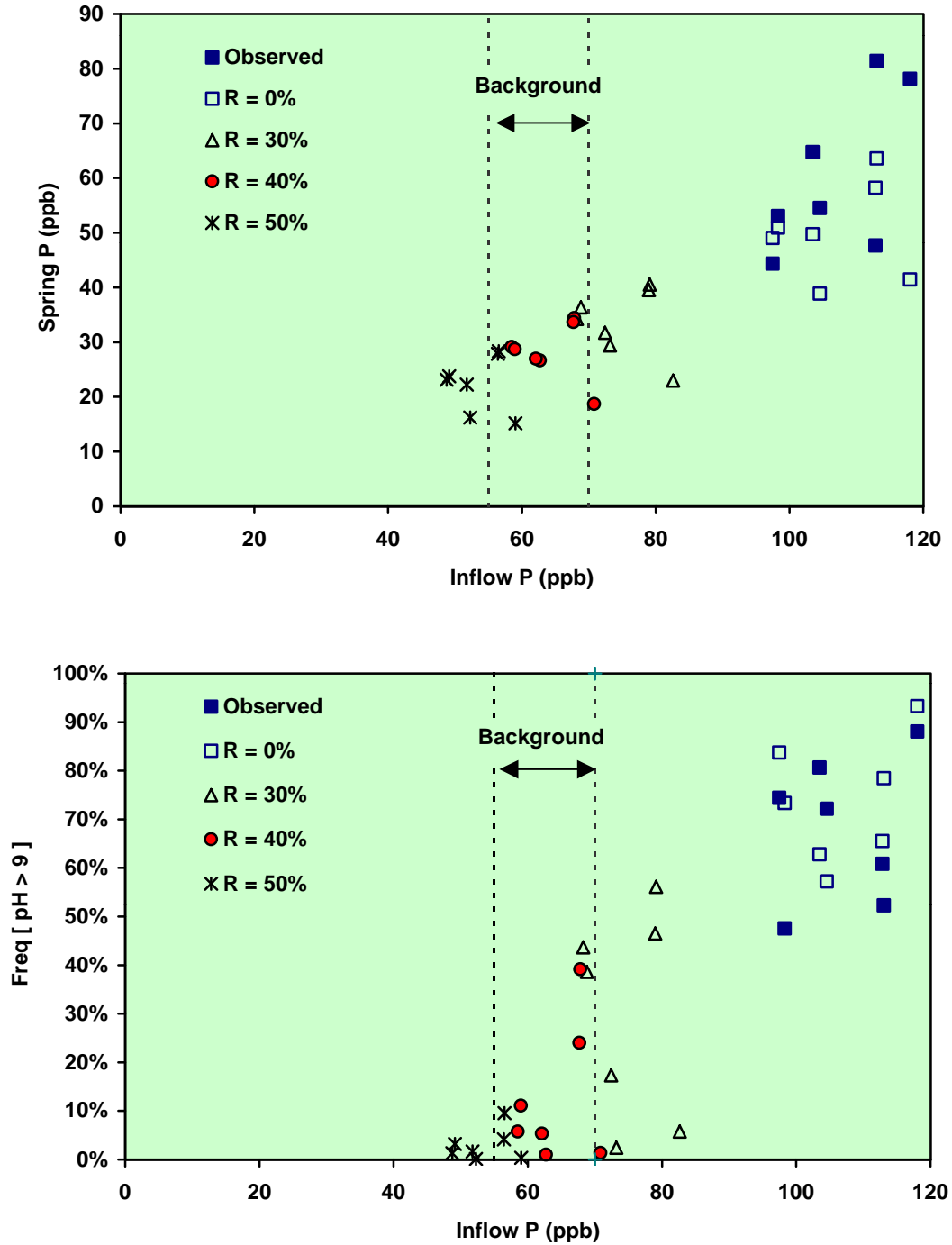


Low, Best Estimate, High = Approximate 80% Confidence Interval for Estimated Background Inflow Concentration (55, 63, & 70 ppb)  
 Corresponding to Reductions of 33%, 40%, & 47% in 1992-1998 Watershed P Loads

**Figure 26**  
**Apparent Trends in Inflow & Lake Spring Phosphorus Concentrations**



**Figure 27**  
**Spring P & Summer pH Excursion Rate vs. Inflow P Concentration**



R = P%, Model Prediction for Total Load Reduction of P%  
 Spring P = March-May Average, Freq [ pH > 9 ] = June-July Average  
 Inflow P = Flow-Wtd-Mean Inflow Conc in Watershed Inflows, Oct-Sept Water Year

## **Appendix A**

### **Spatial & Temporal Variations in Water Quality**

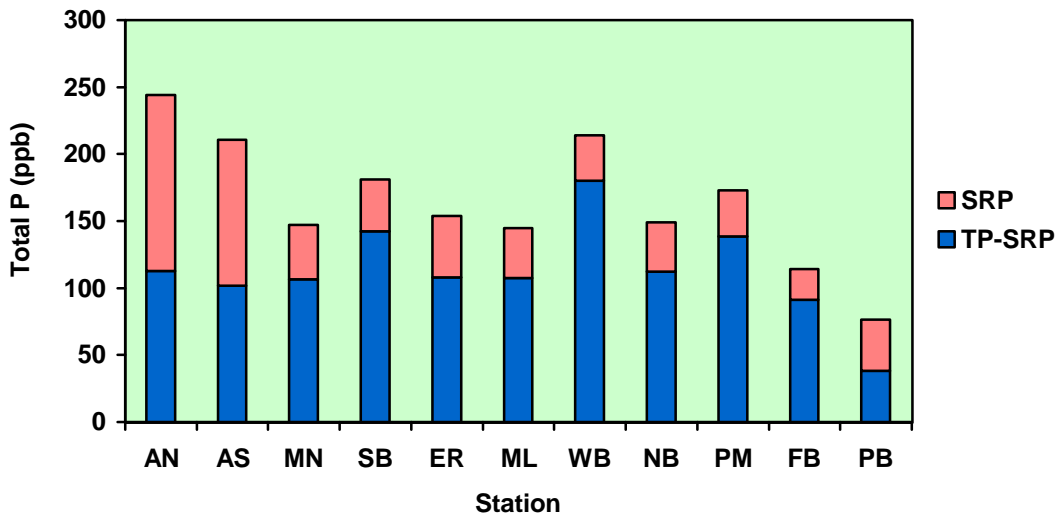
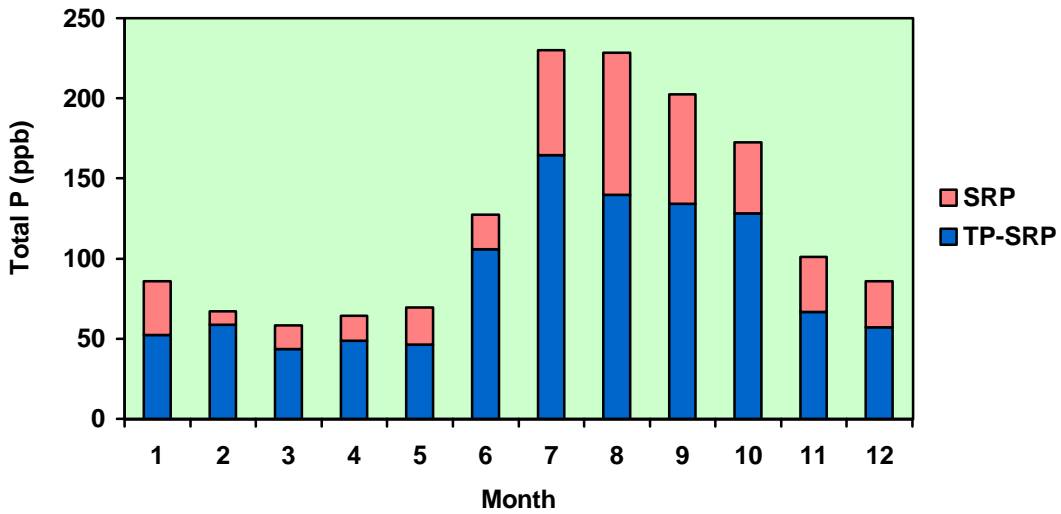
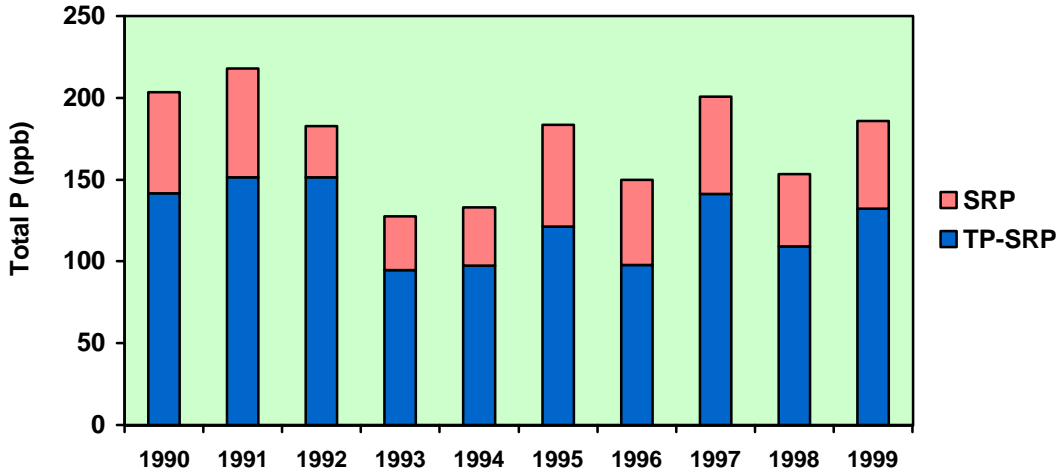
- 1 Phosphorus**
- 2 Nitrogen**
- 3 Chlorophyll-a**
- 4 Algal Bloom Frequency**
- 5 pH**
- 6 pH Excursion Frequency**
- 7 Dissolved Oxygen Excursion Frequency**
- 8 Secchi Depth**
- 9 Light Extinction Coefficient**
- 10 Total N/P Ratio**
- 11 Inorganic N/P Ratio**

Spatial & Temporal Variations in Water Quality

Variable: Phosphorus Species

Months: 5 thru 9

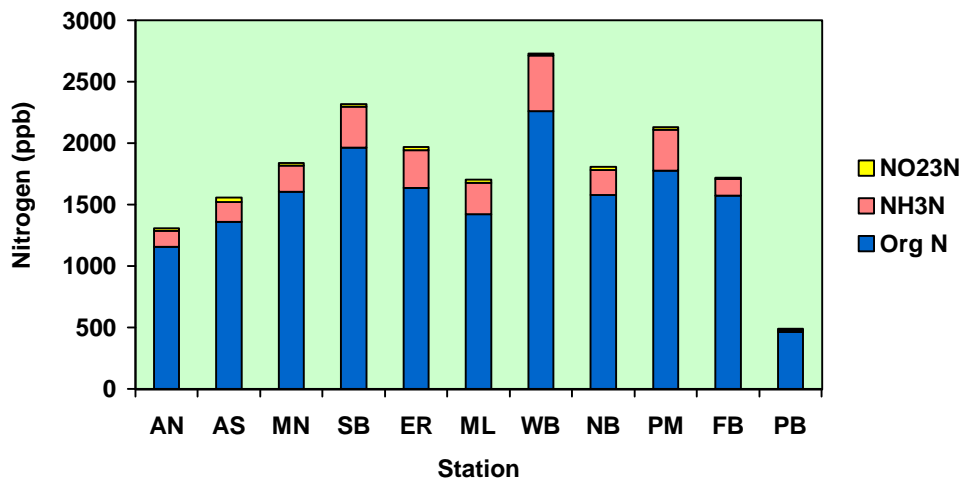
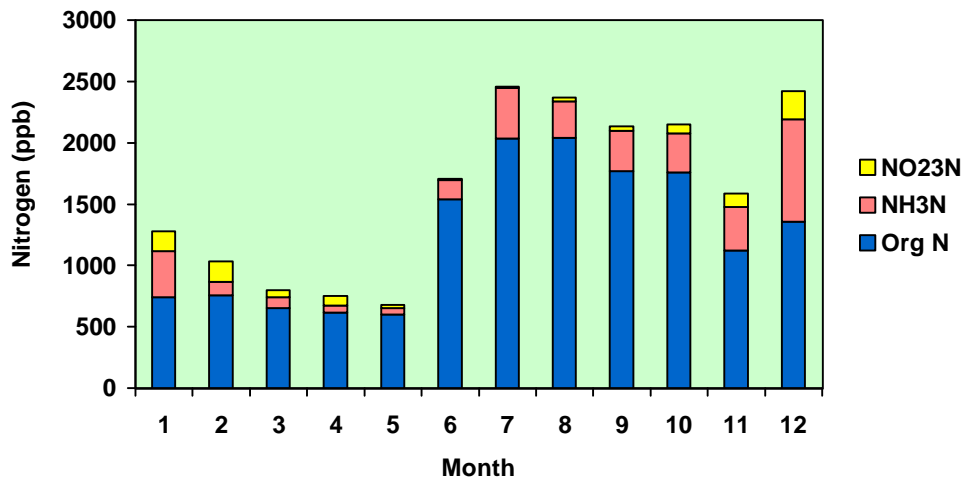
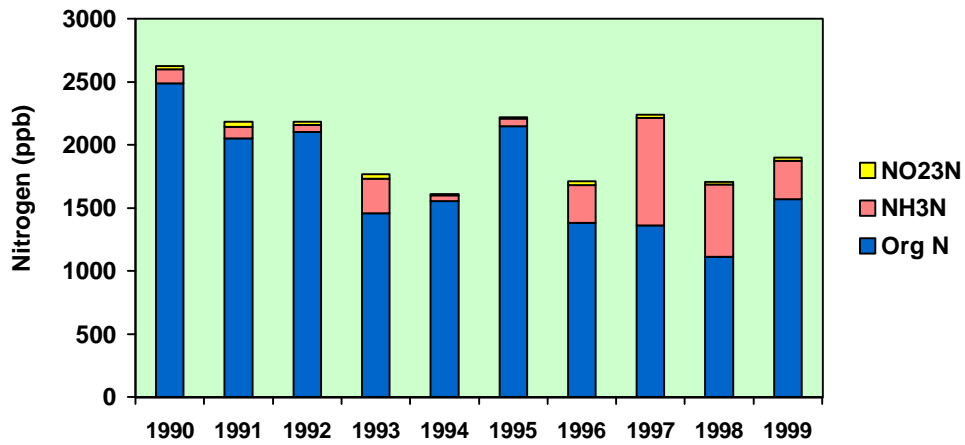
9



Spatial & Temporal Variations in Water Quality

A-2

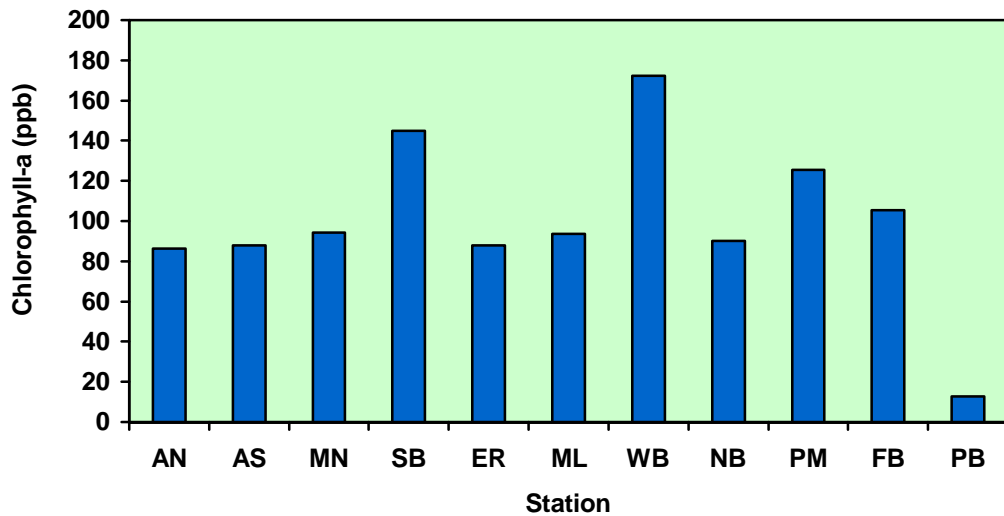
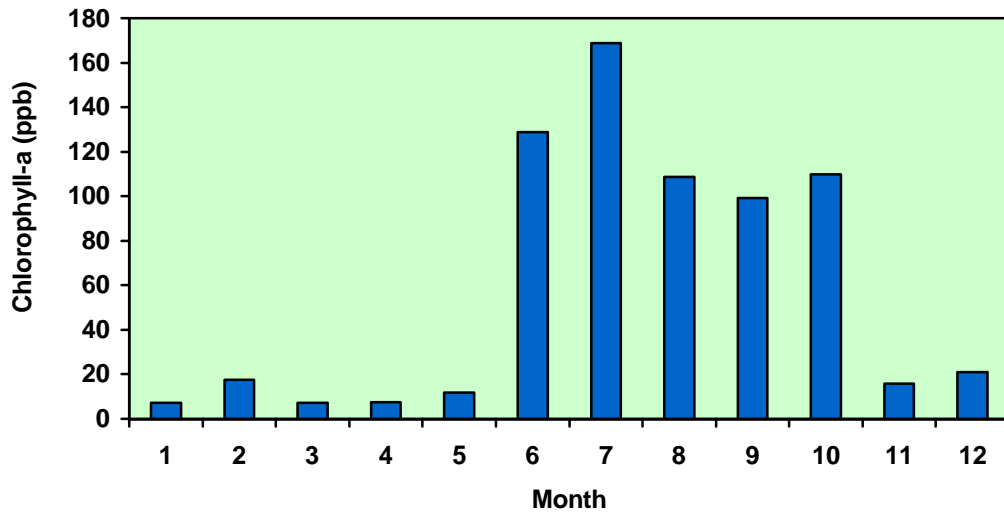
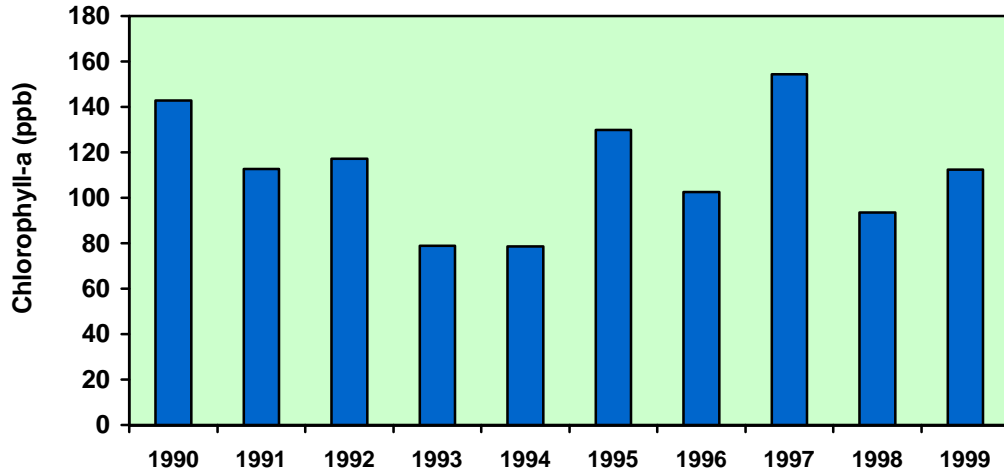
Variable: Nitrogen Species Months: 5 thru 9



Spatial & Temporal Variations in Water Quality

Variable: Chlorophyll-a

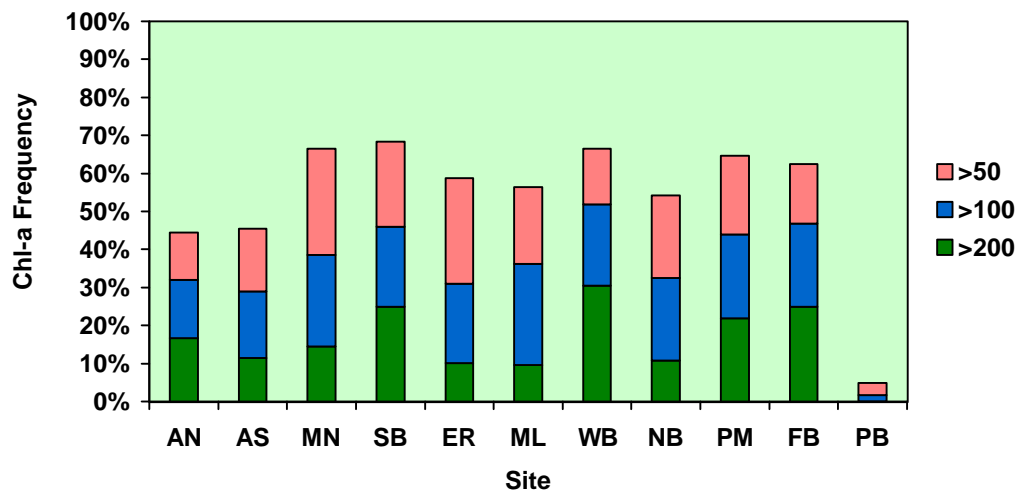
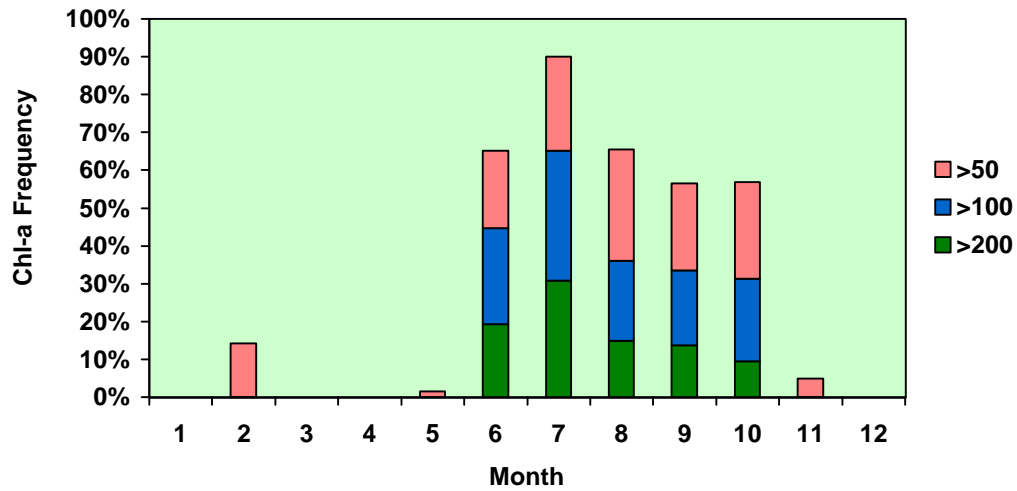
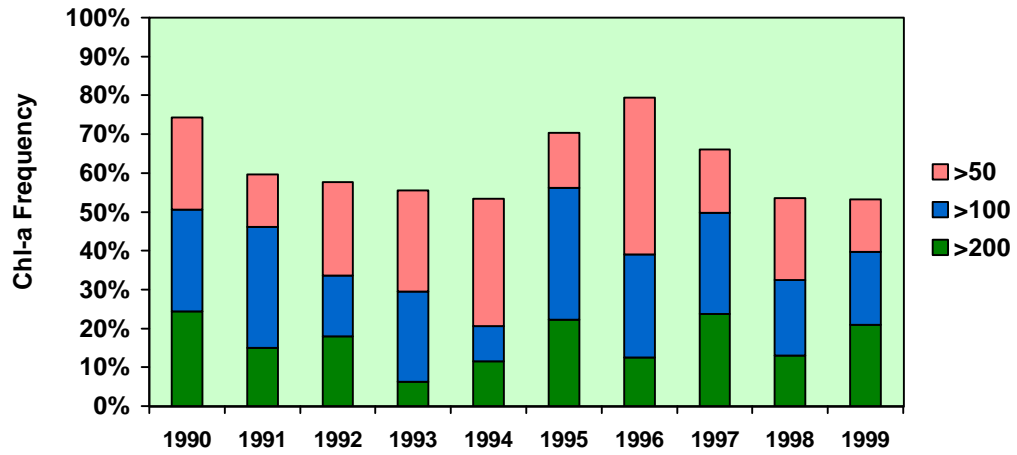
Months: 5 thru 9





Spatial & Temporal Variations in Water Quality

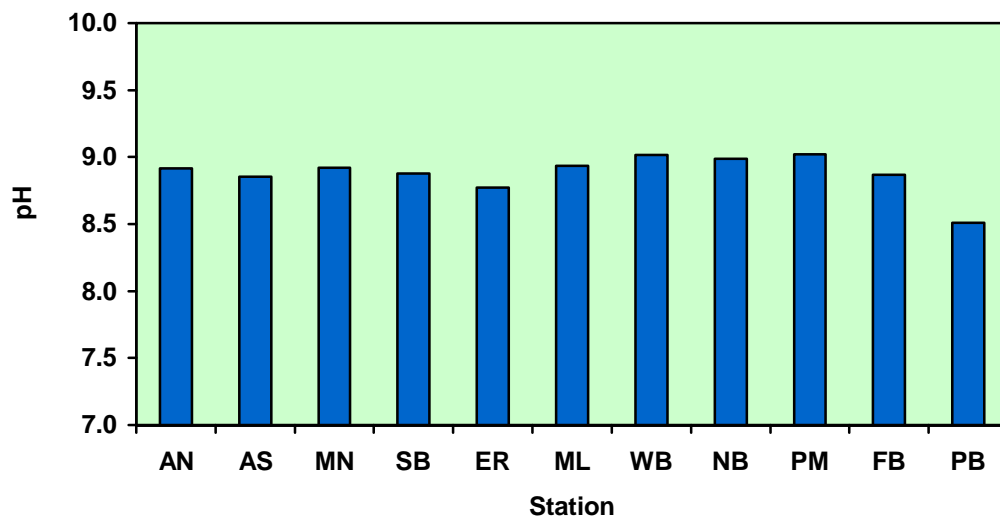
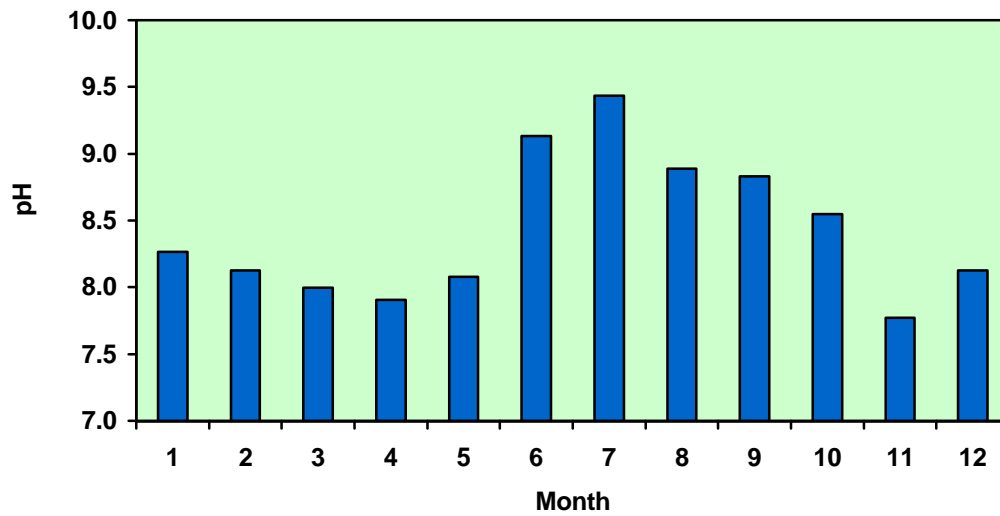
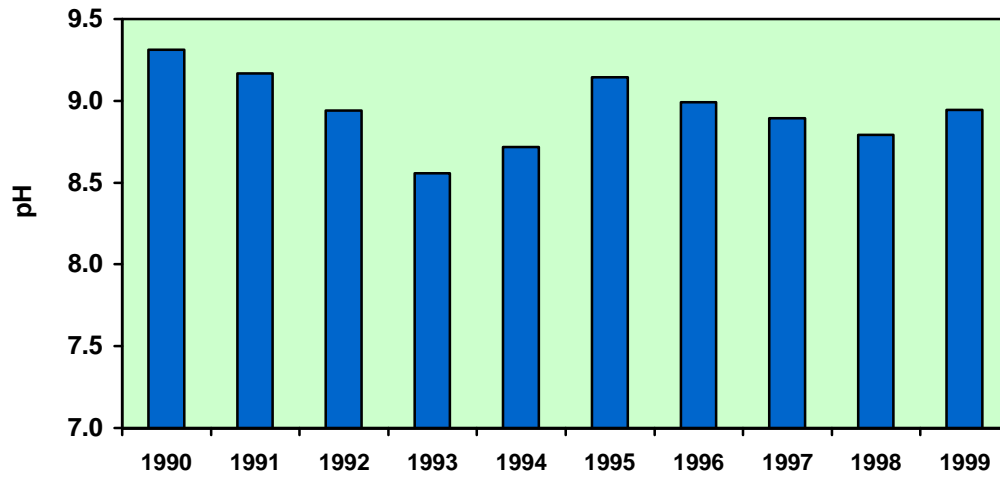
Variable: Algal Bloom Frequency Months: 5 thru 9



Spatial & Temporal Variations in Water Quality

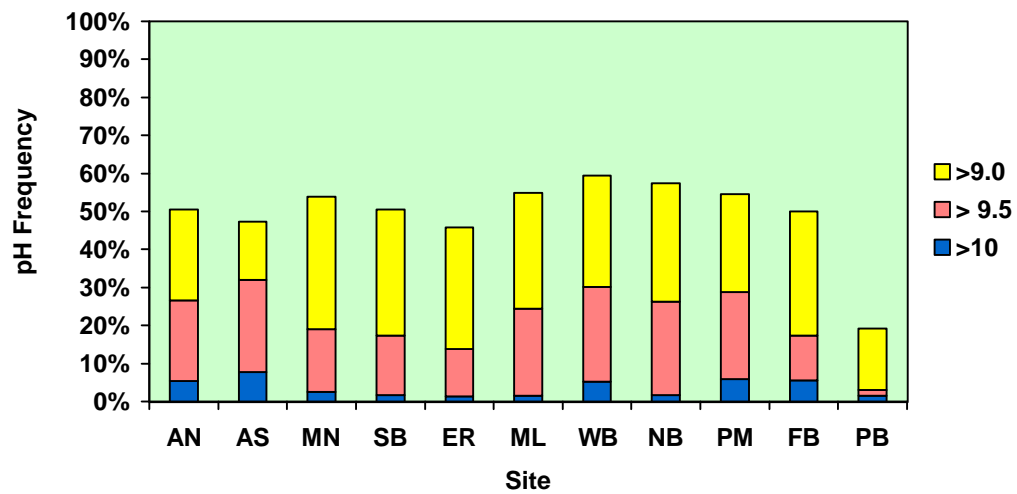
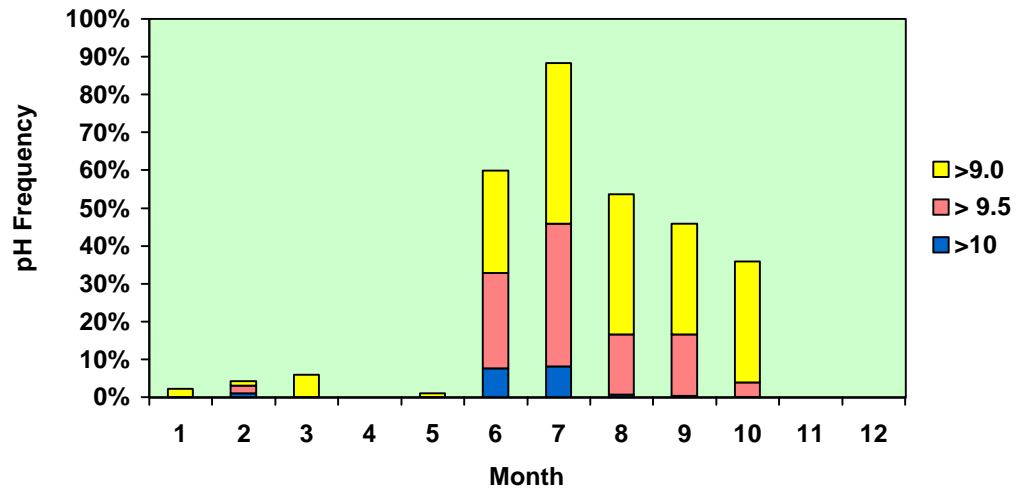
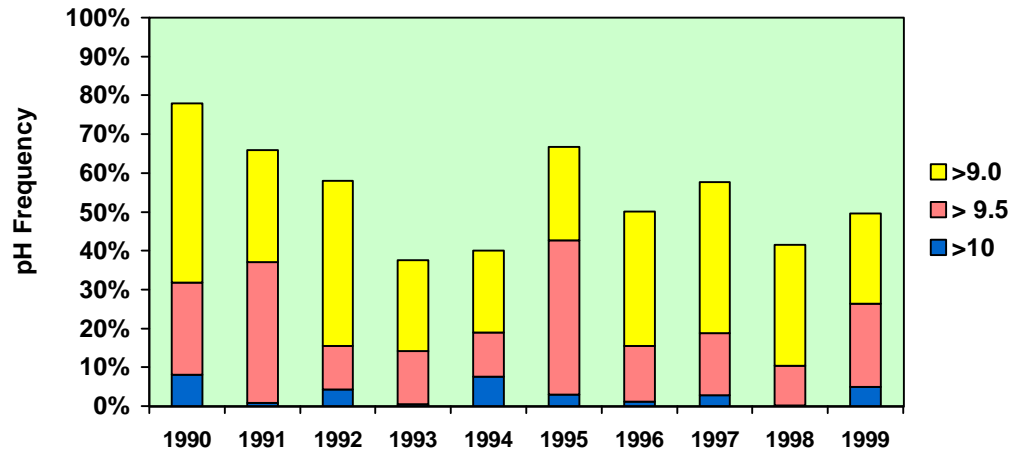
Variable: pH

Months: 5 thru 9



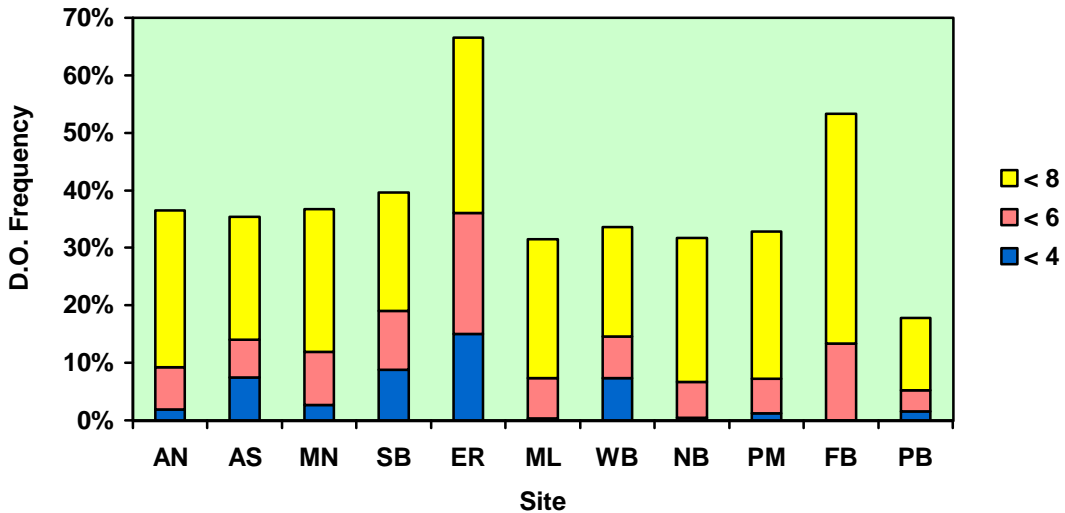
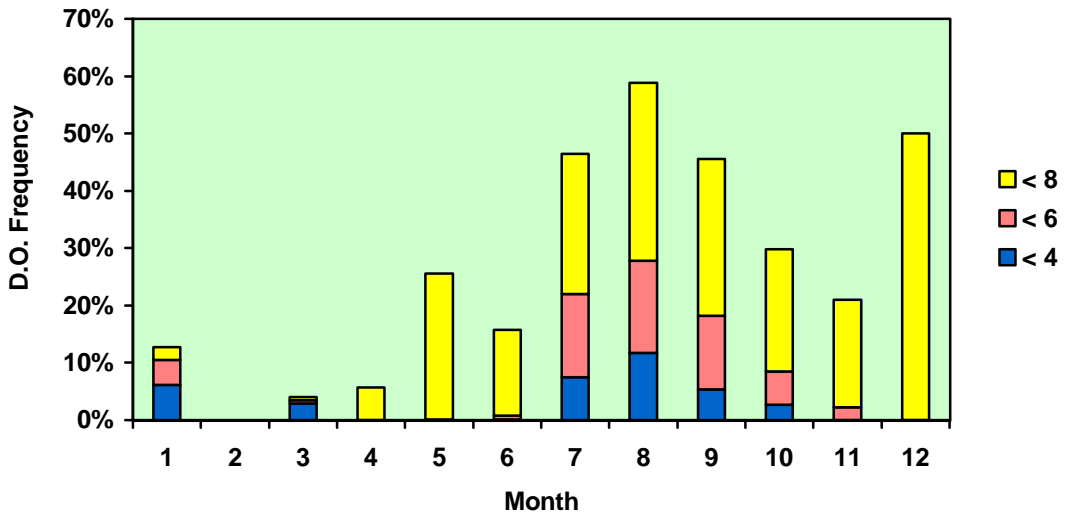
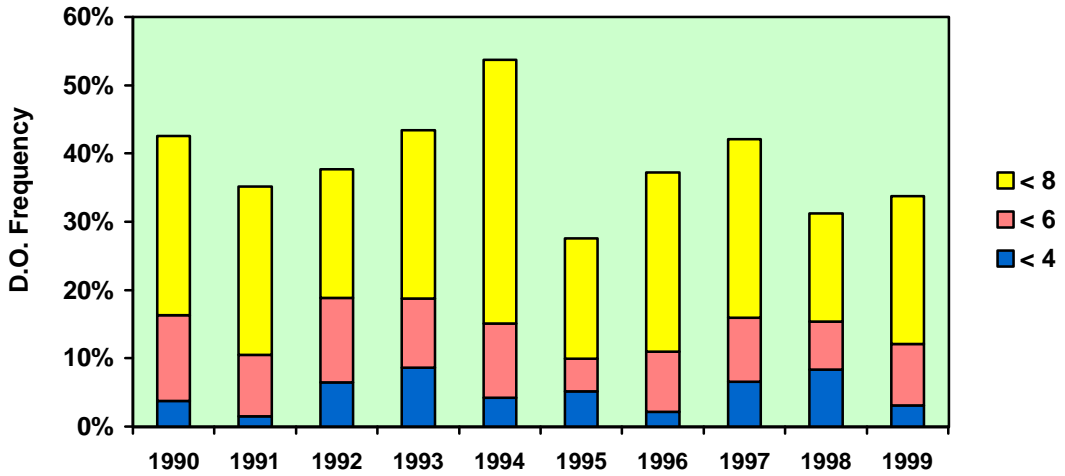
Spatial & Temporal Variations in Water Quality

Variable: pH Excursion Freq. Months: 5 thru 9



Spatial & Temporal Variations in Water Quality

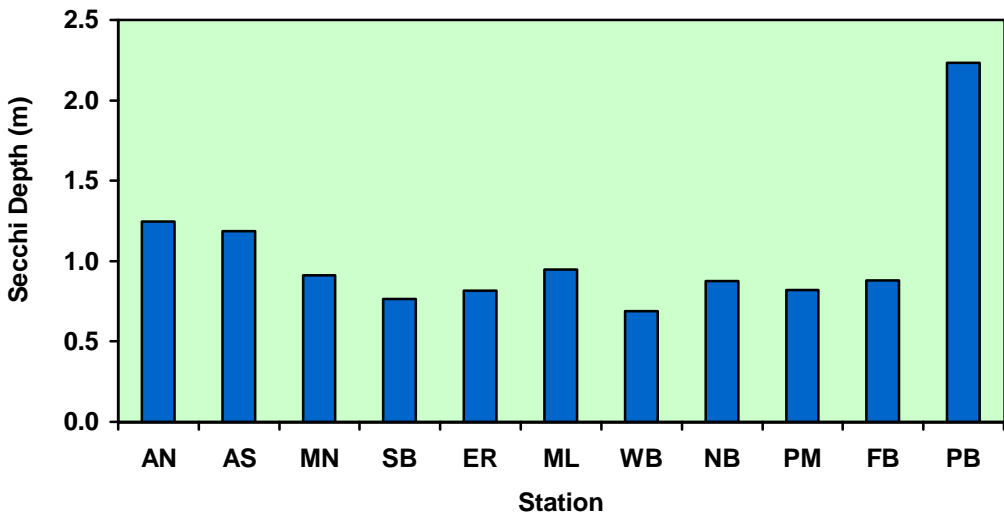
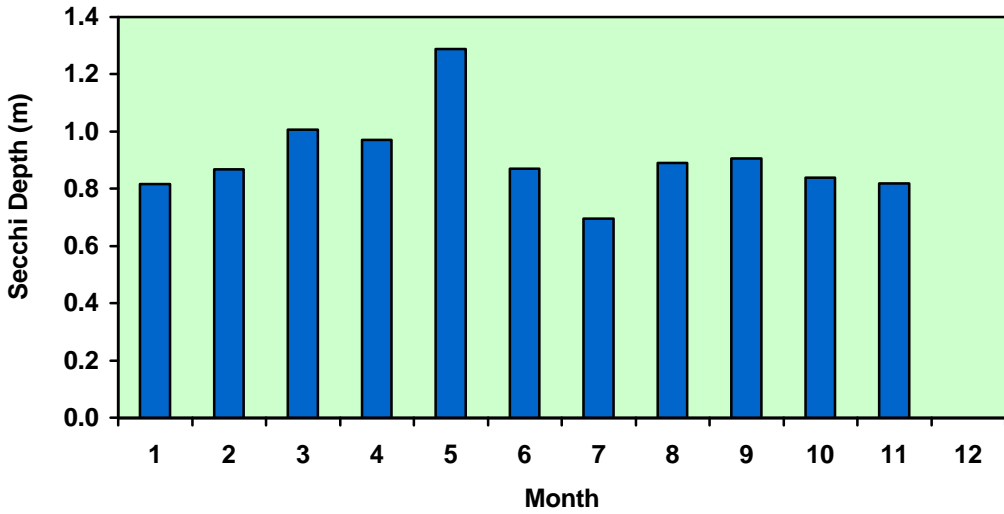
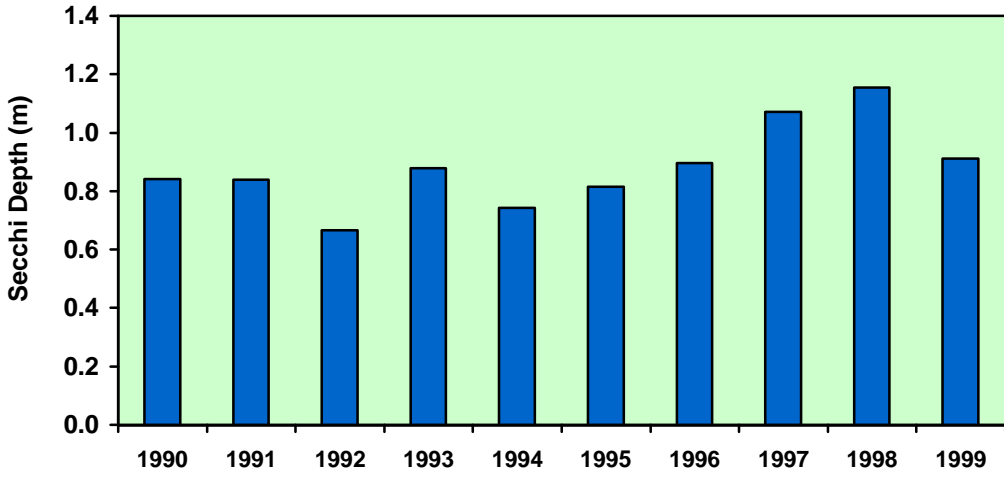
Variable: D.O. Excursion Freq. Months: 5 thru



Spatial & Temporal Variations in Water Quality

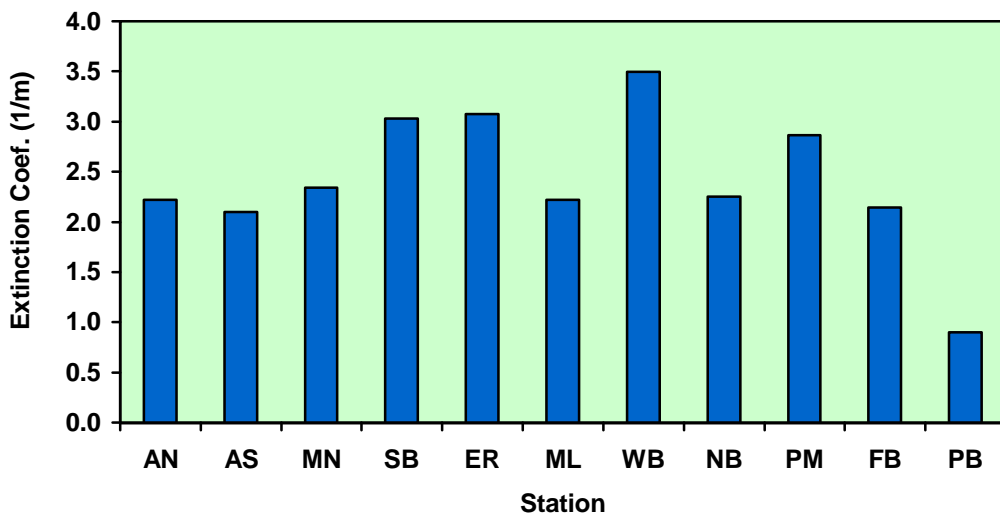
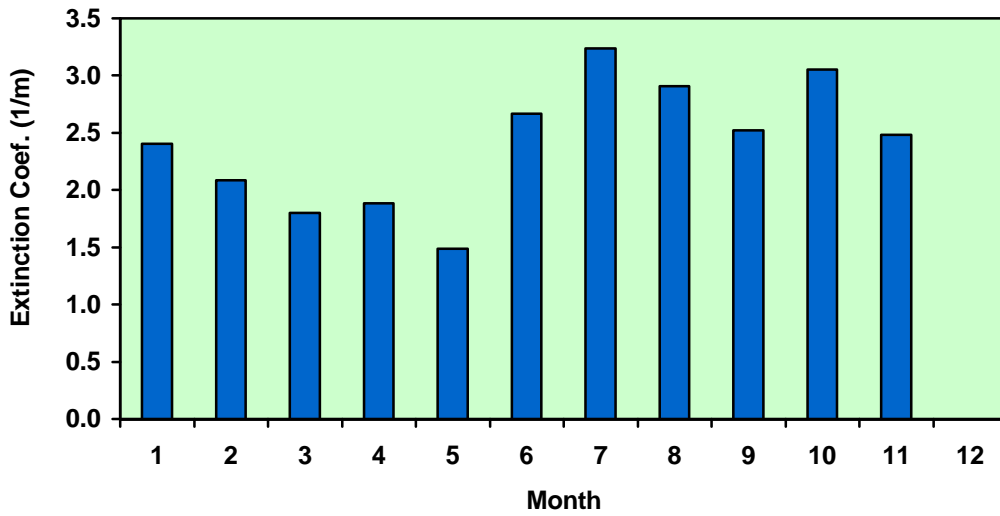
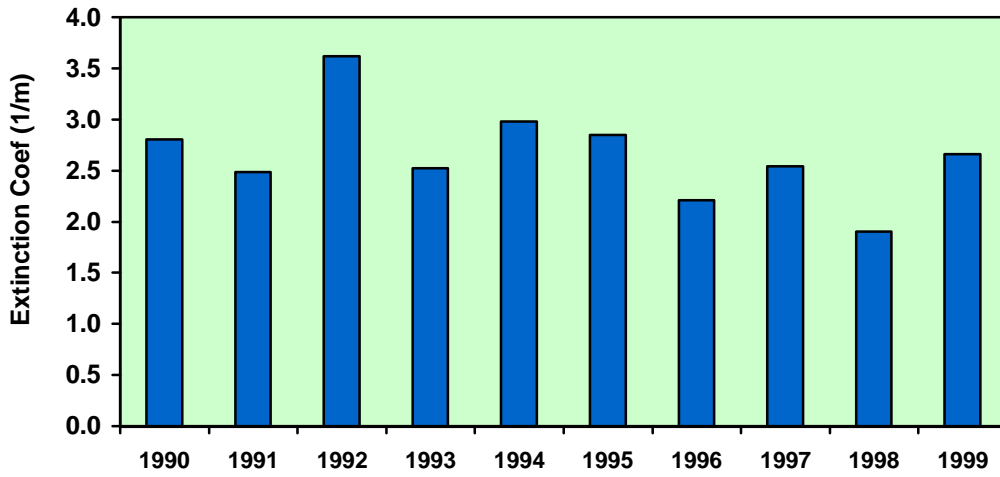
Variable: Secchi Depth

Months: 5 thru 9



Spatial & Temporal Variations in Water Quality

Variable: Light Extinction Coef Months: 5 thru 9

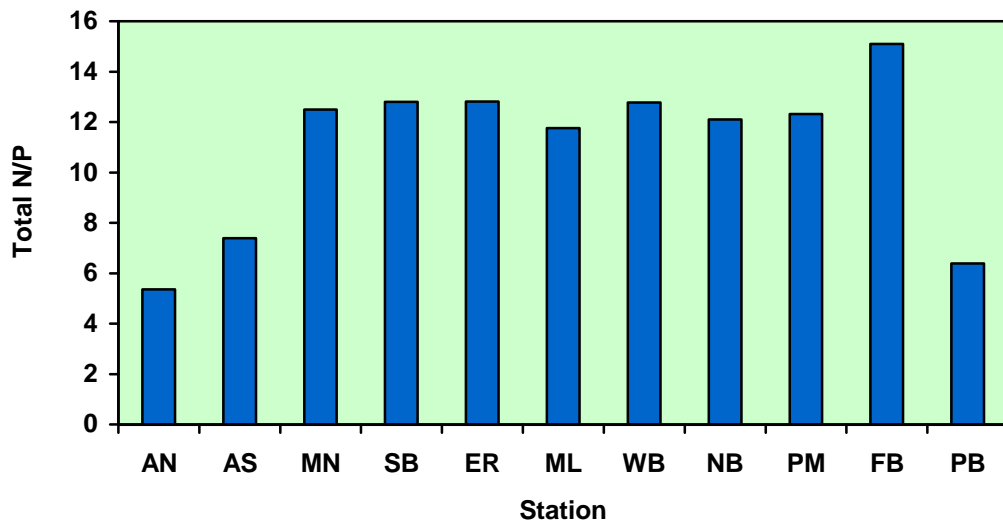
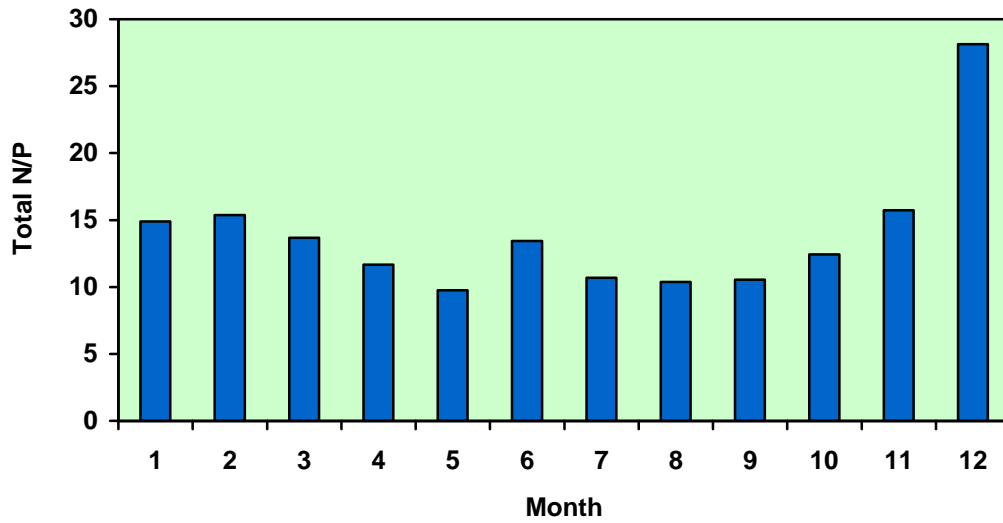
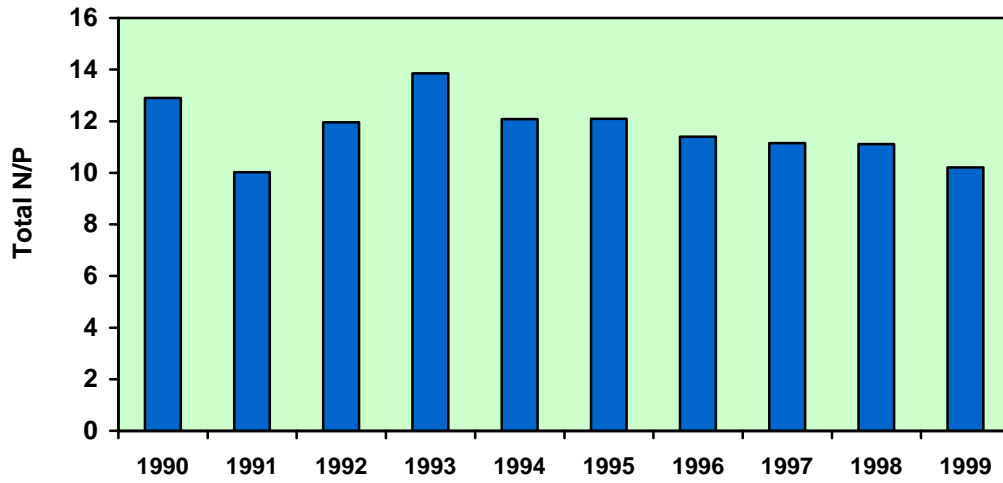


Spatial & Temporal Variations in Water Quality

Variable: Total N/P Ratio

Months: 5 thru

9



Spatial & Temporal Variations in Water Quality

Variable: Inorganic N/ SRP Ratio Months: 5 thru 9

