

An Introduction to Nanoscience and Nanotechnology

Alain Nouailhat

iSTE

 **WILEY**

This page intentionally left blank

An Introduction to Nanoscience and Nanotechnology

This page intentionally left blank

An Introduction to Nanoscience and Nanotechnology

Alain Nouailhat

iSTE

 **WILEY**

Part of this book adapted from "Introduction aux nanosciences et aux nanotechnologies" published in France by Hermes Science/Lavoisier in 2006

First published in Great Britain and the United States in 2008 by ISTE Ltd and John Wiley & Sons, Inc.

Apart from any fair dealing for the purposes of research or private study, or criticism or review, as permitted under the Copyright, Designs and Patents Act 1988, this publication may only be reproduced, stored or transmitted, in any form or by any means, with the prior permission in writing of the publishers, or in the case of reprographic reproduction in accordance with the terms and licenses issued by the CLA. Enquiries concerning reproduction outside these terms should be sent to the publishers at the undermentioned address:

ISTE Ltd
6 Fitzroy Square
London W1T 5DX
UK

www.iste.co.uk

John Wiley & Sons, Inc.
111 River Street
Hoboken, NJ 07030
USA

www.wiley.com

© ISTE Ltd, 2008

© LAVOISIER, 2006

The rights of Alain Nouailhat to be identified as the author of this work have been asserted by him in accordance with the Copyright, Designs and Patents Act 1988.

Library of Congress Cataloging-in-Publication Data

Nouailhat, Alain.

An introduction to nanoscience and nanotechnology / Alain Nouailhat.

p. cm.

"Part of this book adapted from "Introduction aux nanosciences et aux nanotechnologies" published in France by Hermes Science/Lavoisier in 2006."

Includes bibliographical references.

ISBN 978-1-84821-007-3

1. Nanoscience. 2. Nanotechnology. I. Title.

QC176.8.N35N68 2007

620'.5--dc22

2007021734

British Library Cataloguing-in-Publication Data

A CIP record for this book is available from the British Library

ISBN: 978-1-84821-007-3

Printed and bound in Great Britain by Antony Rowe Ltd, Chippenham, Wiltshire.



Mixed Sources
Product group from well-managed
forests and other controlled sources

Cert no. SGS-COC-2953
www.fsc.org
© 1996 Forest Stewardship Council

The Physicists

*“Leaning over the screens of powerful machines
They watch the rise of a world previously unknown
From within their instruments new phenomena appear.”*

(José Maria de Heredia, *Les Conquérants*, adapted by the author)

This page intentionally left blank

Table of Contents

Foreword	xiii
Acknowledgements	xv
Preface	xvii
Chapter 1. What are Nanos?	1
1.1. What are we talking about?	3
1.2. References	7
1.2.1. Two basic facts	7
1.2.2. Two approaches	9
1.2.3. Two key points	11
1.3. Some bonus material for economists	13
Chapter 2. Some Science to Get You Started	15
2.1. Quantum physics	17
2.1.1. From the traditional world to the quantum world	17
2.1.2. Two fundamental concepts	19
2.1.2.1. Wave-corpuscule duality	19
2.1.2.2. Probability in the quantum world	21

2.2. The key players	22
2.2.1. The electron	22
2.2.1.1. The cornerstone of matter	22
2.2.1.2. Electronic states	23
2.2.1.3. The quantification of energy	24
2.2.1.4. Bonds	25
2.2.2. The photon	27
2.2.2.1. The wave.	27
2.2.2.2. The energy grain	30
2.3. Molecules	34
2.3.1. From the smallest molecule to the largest and their spectacular properties	34
2.3.2. Functionality	35
2.4. Solid matter	36
2.4.1. Insulators or conductors.	36
2.4.2. Semi-conductors	37
2.4.2.1. Silicon crystal.	37
2.4.2.2. Electrons and holes.	40
2.4.2.3. Junctions	40
2.4.3. Nanomaterials	41
2.5. Quantum boxes: between the atom and the crystal.	41
2.6. Some bonus material for physicists.	42
2.6.1. Luminescence	42
2.6.2. The laser device.	44
Chapter 3. The Revolution in Techniques Used in Observation and Imagery	51
3.1. Observing with photons	53
3.1.1. The optical microscope in visible light	53
3.1.2. X-ray machines	54
3.2. Observing with electrons	55
3.2.1. The transmission electron microscope (TEM)	55
3.2.2. The scanning electron microscope (SEM)	56

3.3. Touching the atoms	58
3.4. Observing how our brain functions	60
3.4.1. Nuclear magnetic resonance	60
3.4.2. Functional magnetic resonance imaging	61
3.5. Some bonus material for researchers	62
Chapter 4. The Marriage of Software and Hardware	69
4.1. Small is beautiful	71
4.2. Miniaturization	71
4.3. Integration	72
4.3.1. The silicon planet	72
4.3.2. An expanding universe	78
4.4. Programs	82
4.5. Some bonus material for mathematicians	83
Chapter 5. Mechanics of the Living World	89
5.1. Proteins – molecules with exceptional properties	93
5.1.1. The program of cellular production	94
5.1.2. Reading instructions and the production of proteins	95
5.1.3. How does it work?	99
5.1.4. Molecular disfunctioning	100
5.1.4.1. External causes	100
5.1.4.2. Internal causes	100
5.2. Intervention of human beings	101
5.2.1. Medication	102
5.2.2. The creation of those famous GMOs (Genetically Modified Organisms)	102
5.2.3. Manipulation of embryos	103
5.3. Some bonus material for biologists	103

Chapter 6. The Uses of Nanotechnologies	107
6.1. New objects	109
6.1.1. Carbon in all its states	109
6.1.1.1. Nanodiamonds	110
6.1.1.2. Carbon nanotubes	110
6.1.2. A handful of gold atoms	116
6.2. Ground-breaking products	116
6.2.1. Surface treatment	117
6.2.2. Incorporation in a composite environment.	119
6.3. From micro to nanosystems	120
6.3.1. Miniature components – MEMS	120
6.3.1.1. A print head for inkjet printers	120
6.3.1.2. Airbags	122
6.3.1.3. A microlens for miniaturized optics	123
6.3.1.4. Magnetic disk readheads: quantum nanostructures.	124
6.3.2. Microsources of energy: key points for embedded systems	124
6.3.3. Micromotors	125
6.4. A global integration.	132
6.5. Some bonus material for engineers.	139
Chapter 7. Nanos are Changing the World	143
7.1. A simulation or a virtual world	145
7.2. Understanding nature.	151
7.2.1. Understanding energy	151
7.2.2. Understanding materials	152
7.2.3. Understanding information.	154
7.2.4. Understanding life	156
7.3. Watch out for nanomedicine	159
7.4. Nanosciences and our future	161
7.5. Essential ethics.	165
7.6. Conclusion	169

Appendices	173
Appendix A. European Parliament Resolution on Nanosciences and Nanotechnologies	175
Appendix B. Eight Guidelines on Nanotechnologies Issued by the CNRS Ethics Committee	185
Abbreviations	191
Bibliography	195
Figures	197
Index	205

This page intentionally left blank

Foreword

Alain Nouailhat's book takes us on a journey to a newly discovered magical realm. This is the world of the small and the smallest parts, of micro and nanotechnologies. The discovery of this world is, of course, not a recent one, but one which began a long time ago. The ancient Greeks imagined the atom as the smallest unit which could not be split. There then followed a long evolution comprising several different stages before the eventual development of the quantum mechanics model. Recently, a very important step was taken to improve the technology of microscopes. At last we are able to see atoms (in some ways this was already possible with the invention of transmission electron microscopy). However, now we can also manipulate them individually, change their position one by one and use them to create a new code; this is a difficult task but nevertheless it is possible. In fact, we can only create something we can actually see.

In the beginning, there were only two dimensions in nanotechnologies. Specialists in optics then created almost perfect surfaces. The difficulty lay, and still lies, in how to deal with the third dimension. Specialists in electronics working with integrated circuits took part in the miniaturization race going from micro to submicrodimensions, all the while getting closer and closer to the nanometer. Once they reach the stage where they will finally be using a single electron as the basis of electronics (and this day is

still far in the future) the whole idea of electronics will need to be rethought.

This evolution does not only concern electronics, since other fields of study such as mechanics, optics, chemistry and biology have also started creating their own nanoworld; today we refer to these as microsystems. The first example of mass production of microsystems which was not purely electronic was the silicon accelerometer of airbags which can be found in the majority of cars. On the contrary, nanosystems do not yet exist. It will still take some time before they make it out of the laboratories.

As expected, these technological evolutions, not to speak of revolutions, bring with them some concerns since change does not come naturally to humanity and societies. We must therefore be aware of the ongoing challenges and of what is at stake.

I would like to invite the reader to follow Alain Nouailhat on his journey. Let us discover this new world in all its varieties. Alain Nouailhat describes it with the realism of an engineer as well as with the imagination of a researcher; in doing so he shows us a part of his dream.

Jean-Jacques GAGNEPAIN
Research Director at the CNRS,
former Director at the Department of Technology
in the Ministry for Research (France)

Acknowledgements

To my scientific friends who encouraged me and who contributed to my work through their enlightened comments: Jacques Descusse, Research Director at the CNRS (French public research organization), Sylviane Muller, Research Director at the CNRS, and André Toulmond, a highly experienced professor and former Director of the Roscoff Biological Research Laboratory.

To all those who have participated in the illustration of this book.

To the OMNT (Observatory for Micro and Nanotechnology) and ADIT (French agency for the diffusion of technological information) which have been my main sources of information due to their scientific and technological knowledge in an area of perpetual evolution.

To Isabelle Denizet, for carefully proofreading the original manuscript.

This page intentionally left blank

Preface

The term “nanoworld” is understood differently by many experts. Do we have to restrict ourselves to the field of nanomaterials, which consists of building nanometric structures made up of a limited number of atoms? Should we include the miniaturized world which is largely dominated by microelectronics and in which the dimensions of its devices are smaller than a hundredth of a nanometer?

How do we approach concepts which at first glance seem to be very different, ie the link between volume and surface of the different aggregates, the functionality of macromolecules and the complexity brought about by our electronic systems?

In fact, all different scientific disciplines, including every single sector (such as nanomaterials, micro and nanomachines, micro and nanoelectronics), have their own paradigm¹. This is why innovations and industrial developments are profoundly different. However, these fields are strongly interlinked. It is therefore necessary to make our studies more interdisciplinary in order to enable us to understand the nanoworld.

¹ “A paradigm is an image of the world; it describes a way of seeing things, a coherent model which lies on a previously defined basis (a matrix according to the scientific discipline). It refers to a theoretic model in a specific field of science” (Wikipedia).

Taking this idea as a basis for our work, we would like to introduce nanosciences and nanotechnologies in the broadest scale possible by showing their common scientific basis as well as their multiple interconnections.

We will cover different fields in the chapters to come. This is not a straight textbook; those are easily accessible in libraries or on the Internet. The following chapters will both provoke reflection and provide the reader with a better understanding of the subject. This is a guided tour of the discovery of the nanoworld which we hope will arouse the reader's curiosity so that they will engage more profoundly with the subject.

In many different fields we can observe a tidal wave of new products which are directly linked to nanosciences. Therefore, the basic ideas will be introduced and a brief outline will be given in Chapter 1.

Yet, it remains difficult to understand how so many complex domains work together. An understanding of the basic concepts of quantum physics is of great importance as these laws rule the nanoworld. A basic introduction to these ideas will be given in Chapter 2.

In Chapter 3 the functioning of the tools needed to explore the nanoworld will be explained.

We have entered the nano era: progress in the domains of electronics, information technology and telecommunications allows us to bring together fields which were once separate. Microelectronics, which is covered in Chapter 4, has merged with molecular and cellular biology.

Chapter 5 will introduce this convergence and the impressive new perspectives that it opens up. Silicon-based circuits are constantly improving and we can observe the functioning of our

neuronal circuits via MRI². The transistors connect to the biological neurons and enable us to create prostheses which were unheard of before.

The latest innovations, examples of which will be given in Chapter 6, show the applications of nanotechnologies in the domains of materials, motors, energy and also micro and nanosystems. The convergence of these technologies allows for the creation of complex systems.

In Chapter 7 we will deal with the impact on society that these new technologies will have. The chapter focuses on computer simulations which were greatly improved due to better databases and an increased performance in the processing capabilities of computers. These computer simulations have become an essential tool in predicting future developments and in supporting industrial innovations. A large part of our work takes place in a virtual world, which in turn enables us to understand the nanoworld. The object becomes the actor.

Nanosciences and nanotechnologies are leading to a major turning point in our understanding of nature. Such a force has its consequences or in the words of a famous fictional character: every force has its dark side. Our future depends on how we use new discoveries and what risks they bring upon humanity and our natural environment. The ethical implications of this must therefore be discussed.

² Magnetic resonance imaging.

This page intentionally left blank

Chapter 1

What are Nanos? *Putting Things into Perspective*

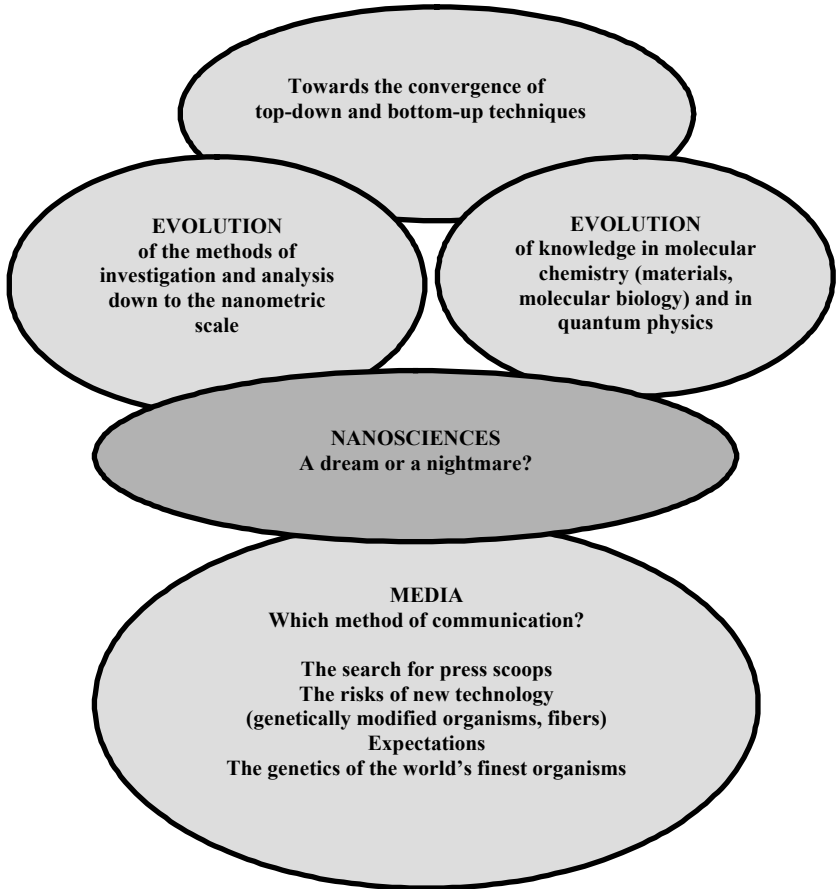

A nanometer = 10^{-9} meter

1.1. What are we talking about?

We are talking about the “nano tidal wave”. Not a single day passes without the press reporting on major innovations in this area. Large industrialized countries spend considerable amounts of money, around US\$10 billion per year, on this field of study. This should have a positive effect on the economy and on employment¹.

Microelectronics and the steady miniaturization of components has become commonplace. Moore’s Law (a doubling of the number of transistors for the same surface every 18 months) illustrates this idea. This also makes us think of the production of chips in laboratories. With their engineers and technicians in uniform, these laboratories can be considered as the technological cathedrals of our times. Microcomputers, microprocessors, mobile phones and MP3 players with a USB connection are available to the general public. For several decades now, this technology has been largely submicronic, and the idea of nanoelectronics was created in the laboratories. The current technological limits will soon be reached, even if ongoing innovations will push them beyond these limits. Emerging technologies such as carbon nanotubes will take over.

¹ In Grenoble, France, the first European center for micro and nanotechnologies, Minatec, has been created. It was inaugurated in June 2006, and with an area of 45,000 m² it is home to 4,000 engineers and researchers who work in the fields of microelectronics, biotechnologies and information technology.

The nanoworld is the intermediary between the atom and the solid, from the large molecule or the small solid object to the strong relationship between surface and volume. Strictly speaking, the nanoworld has existed for a long time and it is up to chemists to study the structures and properties of molecules. They have learnt (with the help of physicists) to manipulate them and build more and more complex structures. Progress in observation tools (electron microscopes, scanning-tunneling microscopes and atomic force microscopes) as well as in analysis tools (particularly X-ray, neutron and mass spectrometry) has been a decisive factor. The production of nanoscopic material is constantly improving, as is the case for the process of catalysis and surfaces used in the nanoworld. A substantial number of new materials with nano elements such as ceramics, glass, polymers and fibers are making their way onto the market and are present in all shapes and forms in everyday life, from washing machines to architecture.

In 1959, the physicist Richard Feynman, Nobel Prize winner for Physics in 1965, came up with the brilliant concept of the nano when he said “there is plenty of room at the bottom” during a conference of the American Physical Society.

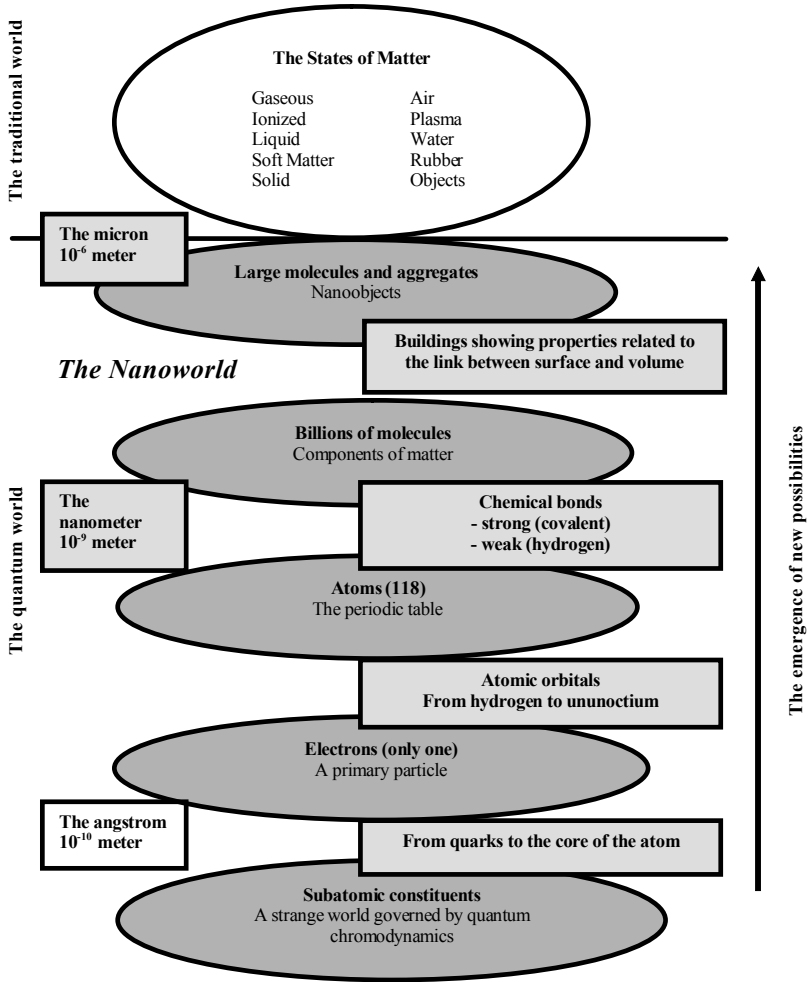

Figure 1.1. Where can we find the nanoworld?

Biology has been molecular for a long time. The areas of DNA, proteins, and cellular machinery are all subjects of multidisciplinary research. Investigations into these fields have been carried out by biologists, chemists, and physicists. Furthermore, the tools that have been developed have created new areas of specialization, such as bioinformatics. Observation, image-processing and simulation all benefit from the advances in information technology and, once more, conceptual progress goes hand in hand with technical expertise.

The concept of the nanoworld is based on the convergence of a real mix of scientific and technological domains which once were separate.

Even though the laws of quantum mechanics based on wave corpuscle duality are not directly visible in our everyday world, except for lasers and semi-conductor components, they do govern the nanoworld. In the future, the quantum effects will be used in a large number of applications, and in objects with new properties, such as quantum cryptography, quantum computers, teletransportation, etc.

The evolution of our know-how, and of technological innovations, is already having significant consequences. The Internet is the fruit of the union between information technology and telecommunications, just as biochips are for electronics and biology. Imaging on a molecular level revolutionized the techniques of medical examinations. The borders between chemistry, physics, mechanics and biology are disappearing with the emergence of new materials, such as intelligent systems, nanomachines, etc.

This is where the nano tidal wave, which will have considerable impact on society, can be found. A comprehensive public debate is required on real or possible risks and their consequences. Will humanity be able to master these new applications or are we taking on an unfamiliar role?

1.2. References

1.2.1. *Two basic facts*

The evolution of knowledge

This is a fabulous adventure where the frontier between fundamental science and applied science becomes an area of exchange and innovation. If the laws of electricity make the electric motor possible, then we can make the same comparison for the electron and television. We are going from the macroscopic to the microscopic.

Technological expertise

Progress in metallurgy and in chemistry has allowed scientists to process silicon. Physicists, in particular, have highlighted its semi-conductor properties. The understanding of these allowed the invention and the production of the transistor. A long succession of successful discoveries and innovations has meant that integrated circuits are now present in everyday objects. If an object can be understood in detail at the microscopic level, we can use our knowledge to apply it to the macroscopic level.

Furthermore, the concept of nano is becoming fashionable as it combines what we already know with new concepts and it conveys the idea of modern technology (eg carbon nanotubes used in top of the range tennis rackets, bicycle frames, or golf clubs).

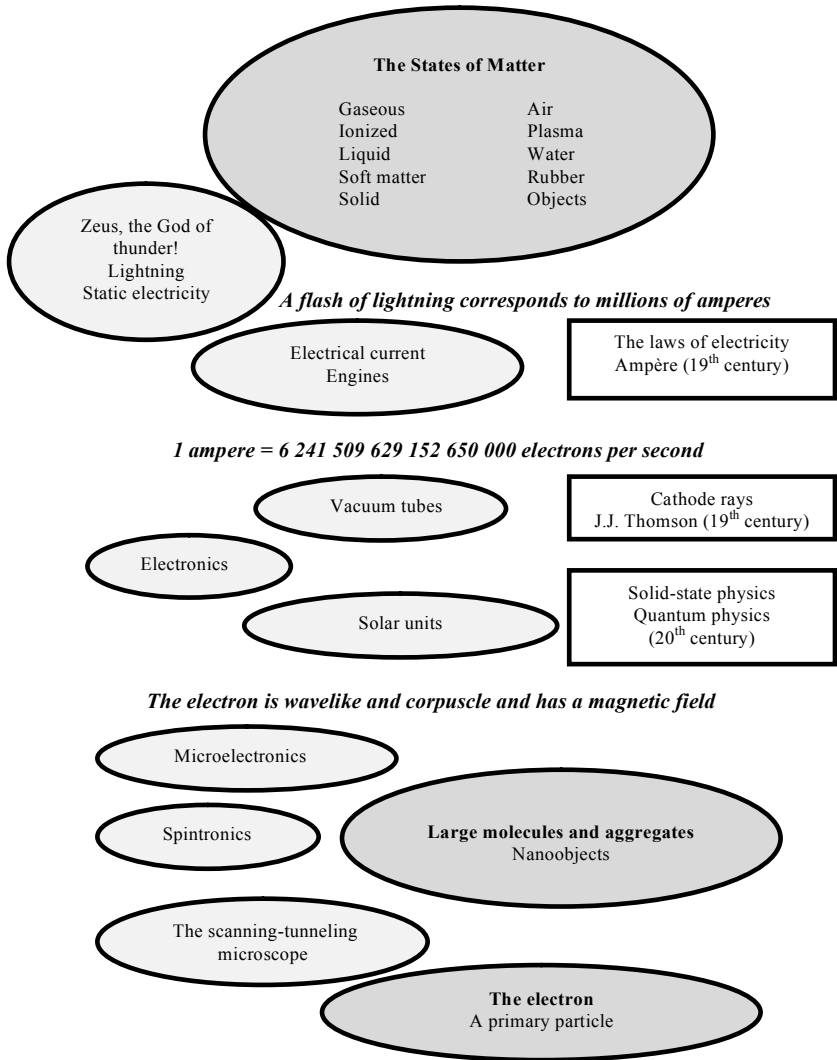

Figure 1.2. *The scientific approach is advancing on all fronts: from lightning to the electron, from the thunder of Zeus to the scanning-tunneling microscope*

1.2.2. *Two approaches*

It seems that the level of knowledge and technical know-how has never been as advanced. This in turn allows for the manufacture of intelligent objects which result from the merging of two approaches:

- top-down, which enables us to control the manufacture of smaller, more complex objects, as illustrated by micro and nanoelectronics;

- bottom-up, which enables us to control the manufacture of atoms and molecules, as illustrated by supramolecular chemistry.

The traditional world has come together with the quantum world. Sectors that were once separate are now coming together. The natural world is of interest to physicists as well as to computer scientists and mathematicians. The divisions between the different disciplines are disappearing and paving the way for new paradigms.

These approaches come together in the nanometric domain.

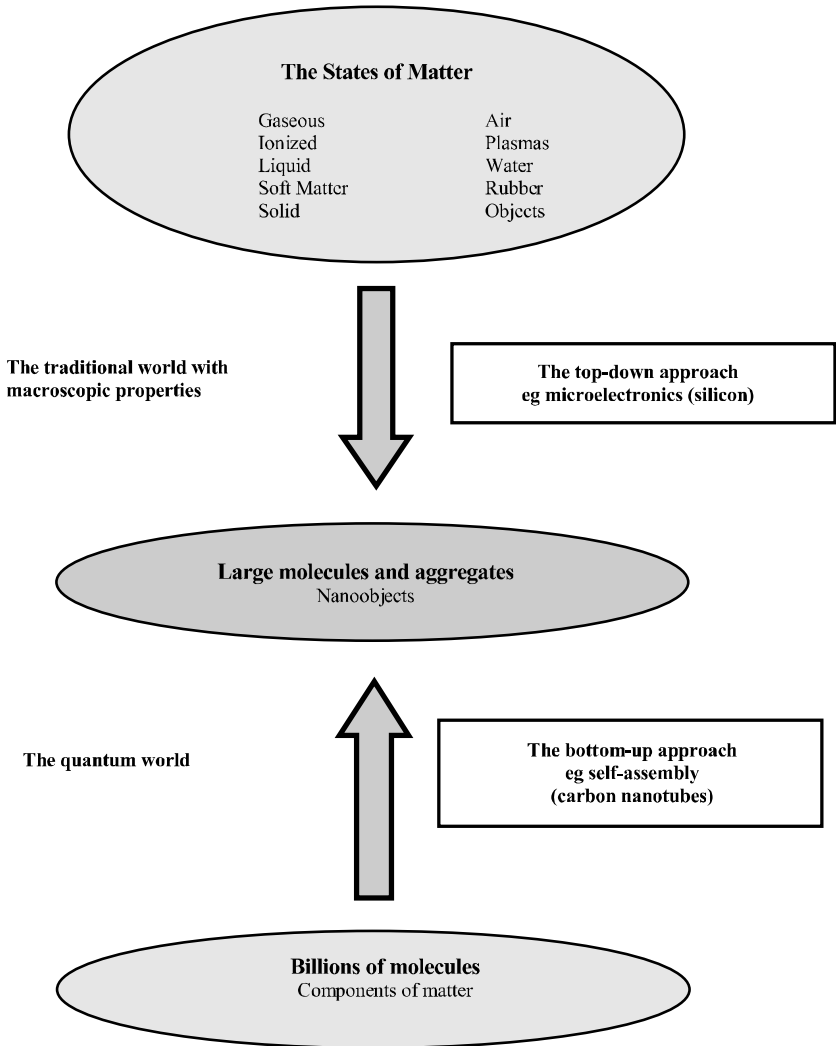

Figure 1.3. *Two technological approaches to the nanoworld: top-down and bottom-up*

1.2.3. *Two key points*

Miniaturization

This process makes it possible to see, work on and manufacture ever smaller objects. In order to do so, increasingly sophisticated technology is required.

Complexity

The integration of ever smaller objects, coupled with a rise in their number, leads to the emergence of new implementations. The appearance of algorithms, with sometimes unpredictable results, brings objects that have been inspired by human genius closer together with objects found in the biological world. The complexity of objects in the biological world is strictly organized and at the same time they are self-organizing. The processes of supramolecular chemistry and of the chemistry of self-assembling materials function in the same fashion.

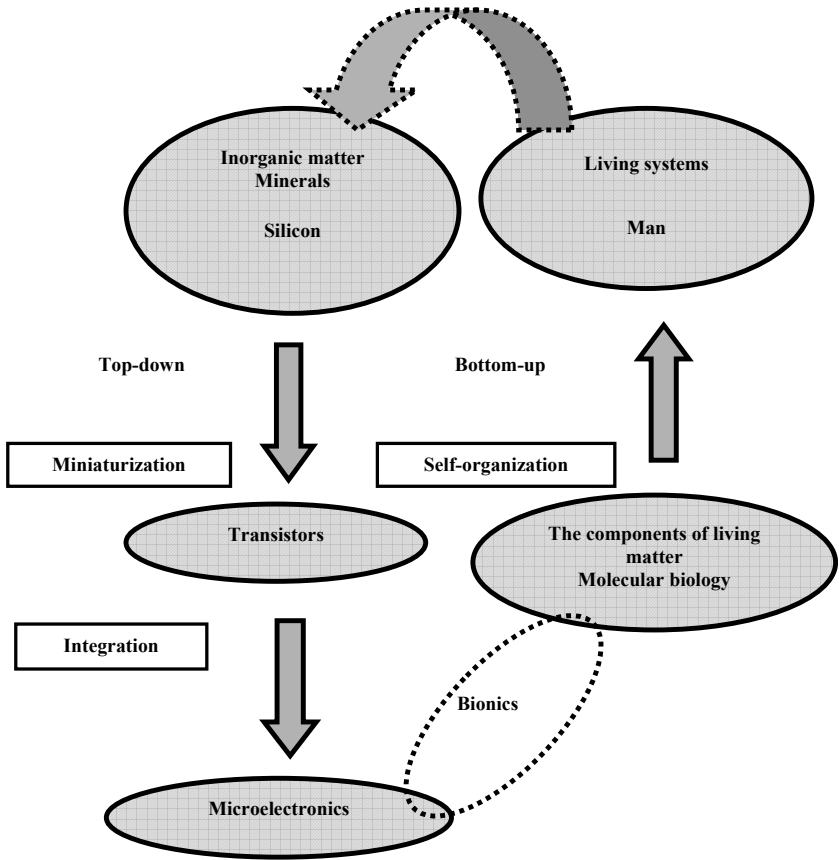

Figure 1.4. Two key points: miniaturization and complexity. Self-organization in the bottom-up approach (eg living systems), and miniaturization integration in the top-down approach (eg micro and nanoelectronics)

1.3. Some bonus material for economists

Recent government measures aim to discover what impacts these new technologies will have on the economy. These measures bring considerable investment in developed countries: the global effort was US\$10 billion in 2004 and this was double the figure from 2003. Large American companies, such as IBM, HP and 3M, invest about one-third of their research and development budget in nanotechnologies. There are more than 1,000 start-ups that have declared that they are carrying out research in the area of nanos.

However, these figures should not to be taken as definitive since they depend on the generally restrictive definition that is given to the area of nanotechnology. Nanotechnologies often share some common ground with microtechnologies from which they are partly derived. Strictly speaking, nanotechnologies do not include technologies measuring up to several tens microns in size, at least not at present. This is frequently the case for MEMS (Micro Electro Mechanical Systems). Furthermore, an ambiguous common ground, if one exists, divides traditional chemistry from modern chemistry in the area of molecular auto-binding, the aim of which is to lead to self-organized materials and systems.

Europe has adopted an active policy so that its member states can remain frontrunners in this competition. Europe is supporting nanoelectronics via the 7th Framework Programme for Research and Technological Development by increasing infrastructure, initiatives relating to health, security and the environment, and introducing a new system of European patent control (see Appendix A).

Miniaturization and complexity

What do the development of cells and organisms have in common with the day-to-day running of a town or society? The answer is complexity. Complexity, under different variants, is present everywhere in the nanoworld.

With regard to products originating from the top-down approach, except when used industrially (when referring to complex industrial systems), it seems that true complexity lies in software or, in other words, in the intelligent objects themselves. The duplication of millions of identical elements, as well as the links between them, admittedly leads to complications. However, complexity can be found in both self-repair and self-learning programs. Thus, hierarchical organization defined in terms of components, machines and systems is moving ever closer to the organization we see in biological systems. In the technology of the future, the recognition of error management and of corrections will reinforce this analogy.

Complexity is a notion that brings unpredictability into play. If biosystems are strongly hierarchical in terms of their level, ie molecules, cells, organisms, and populations, then these four systems are, unlike computers, interdependent. Complexity comes from unpredictable emerging functions in the bottom-up approach. These functions not only provide organisms with the sturdiness they need in order to live, but also create opportunities for evolutionary adaptation depending on the external conditions. It is this concept that is being discovered in new emerging phenomena, which is, of course, understandable, but at the same time is occasionally unpredictable. For example, the multiplicity of interaction loops makes their analysis with genes extremely difficult. Remember that each protein has its own gene code, meaning that each gene determines the chain of a certain number of amino acids. This is only the beginning of understanding how molecular machinery works.

The idea of complexity is, in essence, multidisciplinary. Not only does it introduce us to the graph theory, supramolecular synthesis, modelization and simulation, and thermodynamics of systems that are not in equilibrium, it also introduces us to the information theory, meaning mathematical, chemical, IT, and physical approaches. Observation and calculation techniques, as well as general expertise, are needed in order to advance our understanding of complex systems.

Chapter 2

Some Science to Get You Started

The Necessary Toolkit

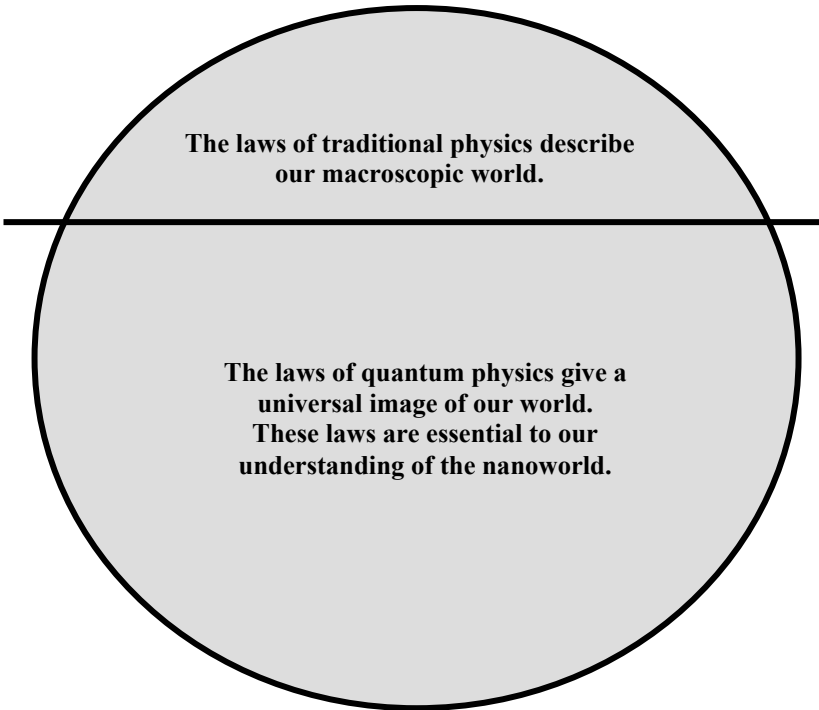

2.1. Quantum physics

2.1.1. *From the traditional world to the quantum world*

The nanoworld is part of our world, but in order to understand this, concepts other than the normal ones, such as force, speed, weight, etc., must be taken into consideration.

The nanoworld is subject to the laws of quantum physics, yet evolution has conditioned us to adapt to this ever changing world. This observation has led us to further investigate theories based on the laws of physics that deal with macroscopic phenomena.

Therefore, the law linking the pressure of a gas “P”, its volume “V” and its temperature “T”, following the equation $P \times V/T = a$ constant, is one of astounding simplicity. It describes how engines work. Each liter of gas, at atmospheric pressure, contains approximately 10,000 billion billion atoms, and because of this immense size we are unable to predict the individual movement of the atoms. This movement can only be observed in exceptional vacuum conditions and in exceptionally low temperatures, but the laws of physics that are applied will no longer be the same.

Let us take Ohm’s Law, $V = R \times I$, which in the field of electricity deals with the relationship between the potential difference from one terminal point on a conductor to the other “V”, its resistance “R” and the flow of electric current “I”. The simplicity and elegance of this equation come from the statistical translation of the number of different behaviors that electrons have; electrons being the fundamental particles for the flow of electricity in the conductor. An ampere, which is a unit of electric current, is the equivalent of approximately 10 billion billion of these small particles moving around per second. Resistance represents a statistical value resulting from the interactions of electrons with atoms. In a gas, the number of electrons is much higher. We can observe the behavior of a single electron, but there again the laws

of physics will no longer be the same. If the notion of electric current is intuitive and does not create any problems of representation, such as fluid analogies, then the electrons in the final component state will not be the same.

Furthermore, in the macroworld, sizes are continuous; however this is not the case in the nanoworld. When we investigate and try to understand what is happening on this scale, we have to, strictly speaking, change the way we look at things. New concepts of quantum physics can only come directly from our surroundings. However, our world is fundamentally quantum. Our common sense in this world has no value in the nanoworld; we have to invent new concepts. This does not happen overnight: little by little, scientists have been able to interpret all known phenomena and give them a joint, common theory which has never been called into question.

This is recent history. In fact, we had to wait for the 20th century and the observation of the atomic world to reach the real limits of traditional physics and create a new branch of physics, quantum physics.

Also known as quantum or wave mechanics, this branch of physics was created by Max Planck (Nobel Prize winner for Physics in 1918) who showed that the exchange of energy between matter and radiation occurred in discontinuous quantities (quanta). The physicist Louis de Broglie (Nobel Prize winner for Physics in 1929) founded wave mechanics. Erwin Schrödinger and Paul Dirac (who shared the Nobel Prize for Physics in 1933) developed the general formulae of quantum mechanics. Finally, Wolfgang Pauli (Nobel Prize winner for Physics in 1945), who is well known for his exclusion principle which governs the states of particles, and other physicists took this theory to the highest degree of accurate prediction in the atomic world.

Until now, no observation has proved the theories of quantum physics wrong and it remains an area that is still under investigation.

Quantum physics also describes an extraordinary world with entirely new properties that are difficult to imagine, but which give us a better understanding of chemistry, transistors and lasers.

2.1.2. *Two fundamental concepts*

2.1.2.1. Wave-corpucle duality

Particles can behave like waves. This property, particularly for electrons, is used in different investigative instruments in the atomic scale:

– The scanning-tunneling microscope, which lets us look at atoms on the surface of a lattice, uses an effect of quantum physics, the tunneling effect, which allows particles to pass through a barrier.

– The electronic microscope whose function is based on the wave properties of electrons, and whose wavelength and speed both correspond to light with a very short wavelength.

Waves can also act like particles: the photoelectric effect shows the corpuscular properties of light.

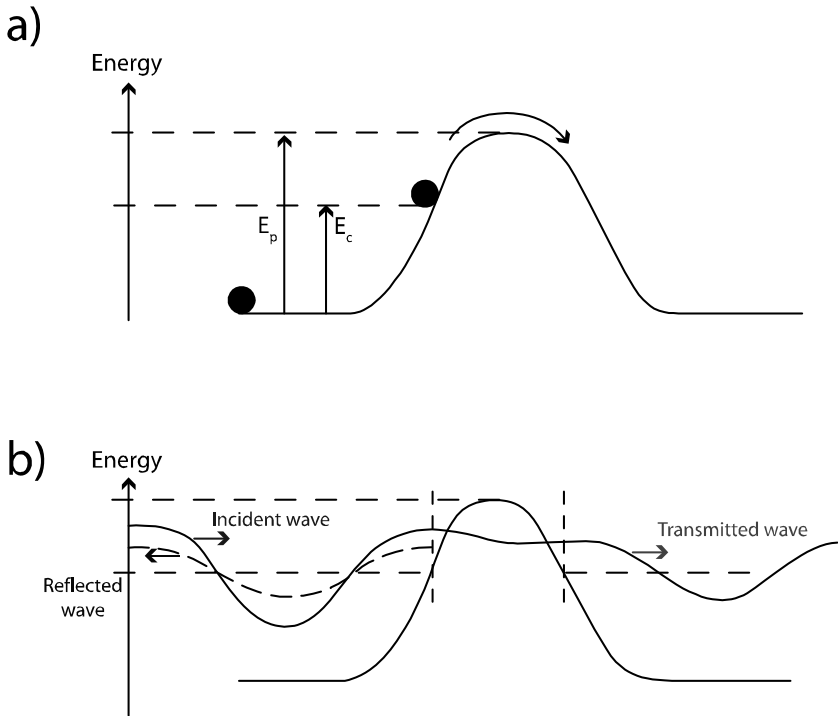

Figure 2.1. An effect of quantum physics: the tunneling effect

a) The passage of a particle through a barrier in the traditional world: the particle does not pass if $E_c < E_p$ and the particle passes if $E_c > E_p$.

b) The passage of a particle through a barrier in the quantum world: the probability of passage is not zero when $E_c < E_p$ and the probability increases with E_c to reach 1 when $E_c = E_p$.

2.1.2.2. *Probability in the quantum world*

Quantum physics gives a completely different version of the world on the nanometric scale than that given by traditional physics. A molecule is described by a cloud of probability with the presence of electrons at discrete energy levels; this can only be represented as a simulation.

All measurable sizes are subject to the laws of quantum physics which condition every organism in our world, from the atom to the different states of matter.

The nanoworld must therefore be addressed with quantum concepts.

Chemistry is quantum.

The chemistry of living organisms is quantum.

Is the functioning of our brain closer to the concept of a quantum computer or to the most sophisticated microprocessors?

All properties of matter are explicable only by quantum physics. Traditional physics, which is certainly efficient and sufficient in the macroscopic domain, only deals with large objects (remember that there are nearly 10^{23} atoms per cm^3 in a solid), while quantum physics only deals with small discrete objects. However, the evolution of techniques and the use of larger and larger objects stemming from scientific discoveries make us aware of the quantum nature of our world in all its domains. Our vision of this has been completely transformed, and our lives have been changed as a result.

Just as Alice did in *Alice in Wonderland*, we are going to have a look at things from the reverse side. Before leaping into the submicronic world we need to understand some of the key ideas that await us there.

Fasten your seatbelts!

2.2. The key players

2.2.1. *The electron*

2.2.1.1. *The cornerstone of matter*

Everything starts with the atom, the building block of the nanoworld, and also of our world. Mass is predominantly concentrated in the nucleus of the atom, which is made up of particles called protons which have a positive electric charge, and of neutrons which are neutral, but which have the same mass as protons. The neutrons stabilize the confinement of the protons which are subject to their mutual electrostatic repulsion. This nucleus is packed with negatively charged particles called electrons which are equal in number to the number of protons. The atomic unit is therefore neutral. It is the distribution of electrons that is the origin of the atom's chemical properties.

The electron is a particle. It has a weak mass, almost 1/2,000 of that of a proton, and it carries the basic electric charge that creates electricity. Like the proton, it has a magnetic field called spin that leads to magnetism which has multiple uses; we will see more of this later. But this is not all; the electron is also a wave, the frequency of which depends on its energy. Without it, the world would not exist. It is not enough to compare the image of small electrons orbiting around the nucleus to the planets orbiting around the sun, or to compare the electrostatic force of attraction in atoms to the force of gravitational attraction for the planets. It neither explains the stability of the system, for example any perturbation ends with the electron falling on the nucleus, nor does it explain the organization of the electrons around the nucleus. It is their undulatory structure that explains the atomic structure: electrons group themselves into zones according to the stationary modes of their corresponding waves. Everyone can see how stationary modes work by observing resonance phenomena in the field of acoustics, for example in the vibration of guitar strings.

2.2.1.2. *Electronic states*

It is clear that for the atom, things start to become more complicated.

Electrons occupy discrete states, in other words quantum states. In the quantum world, the continuous does not exist and places are numbered. The various different states are predefined and are identified by a number.

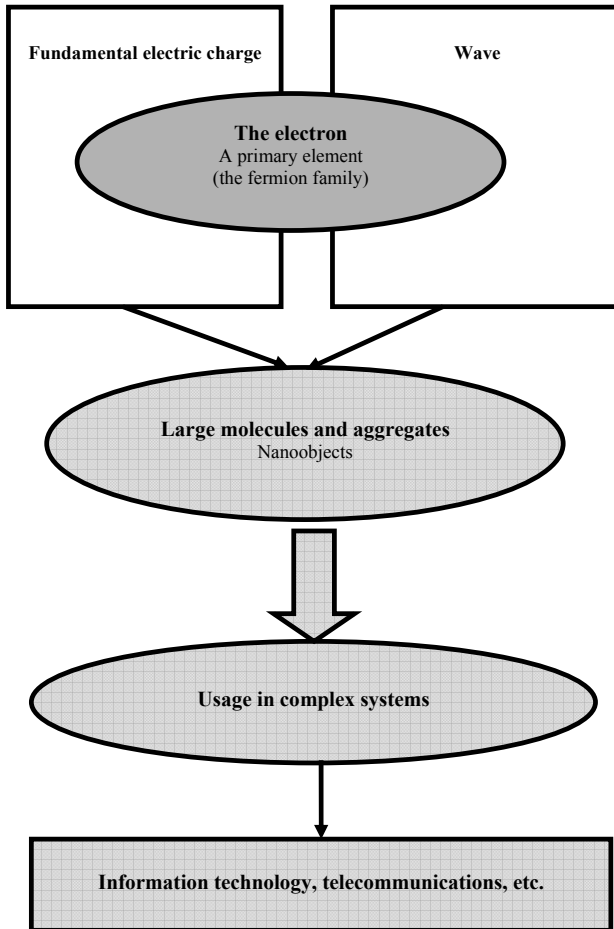

Figure 2.2. *The electron, a universal actor*

Two electrons can occupy, at most, one state, which is due to the existence of two spin values¹. As we look closer, the atom becomes heavier and the number of electrons increases. They are divided in an orderly fashion around the nucleus, forming concentric shells starting with the one closest to the nucleus, just as you would fill up a theater from the front row to the back. Each shell has a limited number of states. The most important shell for interactions between atoms is the outer shell which has four states, meaning that there is enough space for eight electrons, except for hydrogen and helium. This has fundamental consequences.

The ranking of atoms by their mass in relation to their chemical properties highlights this periodicity; in other words Mendeleev's periodic table of elements. Thus, when there is only one electron on the external shell we are dealing with alkali metals, such as lithium, sodium, potassium, and rubidium, all of which come from the first column of the periodic table. When the outer shell is full, meaning that when there are eight electrons on the shell, we are then dealing with the noble gases, such as helium, neon, and argon, which make up the eighth column of the periodic table. Hydrogen, which has one proton and one electron, plays a key role in molecular construction and in our world in general. Its external configuration determines other chemical properties.

2.2.1.3. *The quantification of energy*

A key idea in the atomic world is that of quantification. As no two states are the same, every exchange that occurs between them must be carried out through “packets” of energy, each with a

¹ Particles with half-integer spin, which are called fermions (the electron), and particles with integer spin, which are called bosons (the photon), have different quantum statistics. In particular, several bosons can simultaneously occupy the same state. Pauli's Exclusion Principle does not apply to bosons, but is applicable to fermions.

defined value which corresponds to the energy difference between them. In the atomic world, every process must be carried out step by step; there are no short cuts. It is still possible for an electron to be excited if it receives enough energy to progress to a superior level, if one is available and not already occupied. This energy can be supplied by a shock, in particular by light stimulation. It is the process of atomic absorption which lets us probe the atoms in order to find out more about their different states. The reverse occurs if we remove an electron from one of the outer shells. In this case, there will be a knock-on effect leading to the source of the light. The balance that is reached always corresponds to a minimum level of energy.

All of these properties are used in nanometric objects.

2.2.1.4. *Bonds*

Thanks to their surface electrons, atoms form more complex edifices: molecules or solids which create new properties. The fixing between atoms is known as chemical bonding.

The concept of bonding is as old as that of the atom. Its most famous interpretation comes from the Greek philosopher Democritus who saw that the bonding between atoms was a property linked to their shape, smoothness, and ability to lock onto other atoms. Chemical bonding can only really be explained with the knowledge of the quantum nature of the electron.

We have seen that the outer shell has between one and eight electrons. Chemical bonding between atoms is due to the pooling of one or several electrons from their outer shells in order to make sure that each shell is surrounded by eight electrons. This is known as covalent bonding. This allows atoms to join with one another and allows for the creation of complex atomic edifices known as

molecules. A good example is given by stacking pieces of Lego together in order to create larger complete structures. The bonding force for atoms is based on the fact that the energy from the state created by the two shared electrons is weaker than the two independent states. More precisely, while the atoms approach one another, the atomic states taking part in the covalent bond will form two molecular states, one of which is bonding and the other, with a superior energy level, is anti-bonding. Each state accepts two electrons of opposing spin; the bonding molecule is full and the other anti-bonding one is empty.

Physicists talk about molecular orbitals, often represented in chemical formulae by a line, for example the C-C bond between two carbon atoms. This idea of a molecular orbital is very useful for visualizing the bonds between atoms. This is the most solid bond in chemistry, the universal adhesive which forms the basis of semi-conductor materials such as molecules of living organisms.

Other types of bonds exist based on electrostatic interactions; in particular the bond that is associated with the presence of hydrogen. These are very useful for carrying out reversible fixing like the adhesive on Post-its. In large organic molecular edifices we find these structures mixing with strongly bonded parts (covalent bonds), joined together by easy to remove fasteners (hydrogen bonds), ensuring the robustness and suppleness of the dynamic world of living organisms. These strong and weak bonds are found in nature.

2.2.2. *The photon*

2.2.2.1. The wave

We live in a world of photons made up of the electromagnetic spectrum which goes from radio waves to X-rays and then gamma rays. We have a very limited perception of the electromagnetic spectrum; visible light is the only part of the spectrum that is directly captured by the eye. Our body perceives infrared rays in the form of heat through sensors in our skin and reacts to ultraviolet rays by tanning and sunburning as well as, unfortunately, developing skin cancers.

We have only been aware of the existence of radio waves due to developments in electricity, and of X-rays thanks to research on atomic structure at the end of the 19th century. Light travels at a speed of 300,000 km per second in a vacuum, which definitely comes from Maxwell's electromagnetic theory in the 19th century which in turn explains all the phenomena linked to electricity and magnetism through the use of four mathematical equations.

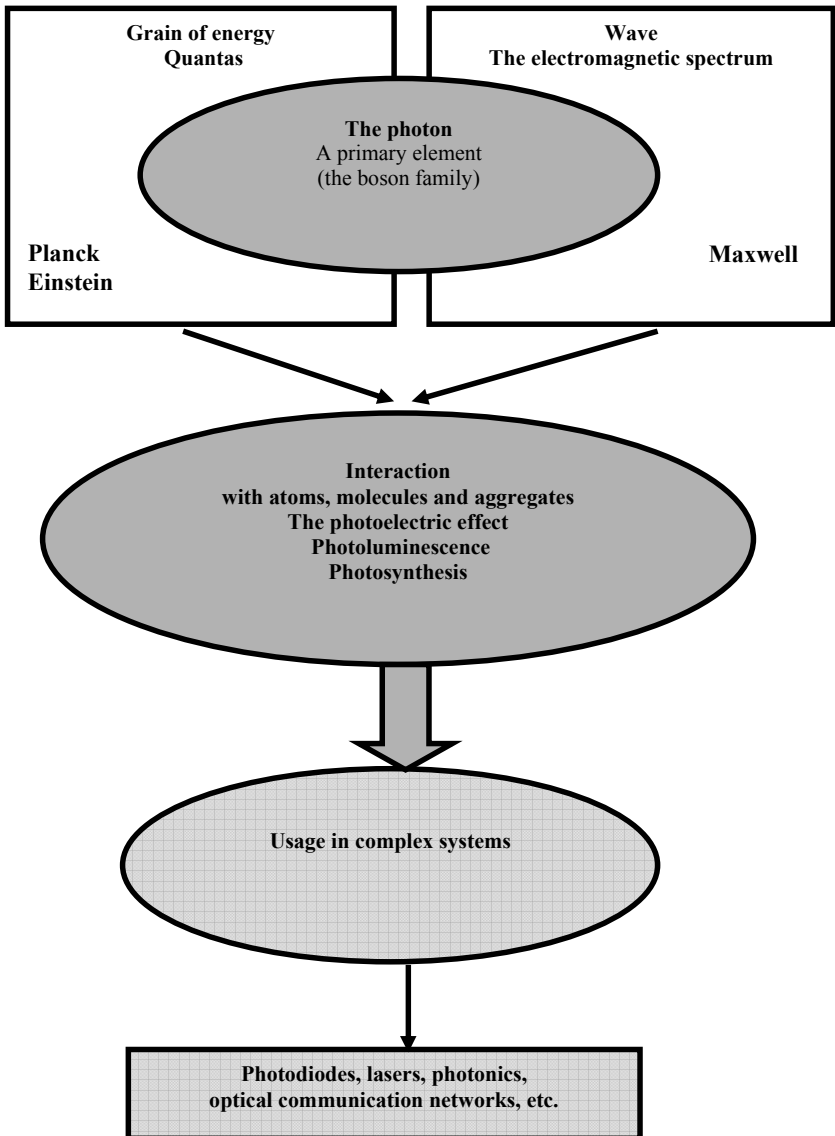

Figure 2.3. *The photon, a super fast messenger*

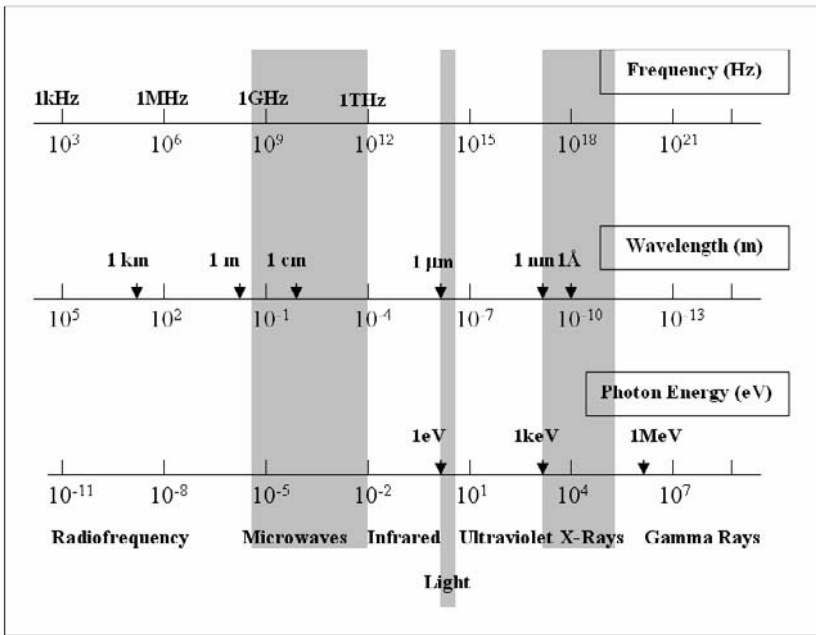

Figure 2.4. The electromagnetic spectrum

Units of abbreviations:

Hz	hertz	m	meter	eV	electronvolt
THz	terahertz	Å	angstrom	MeV	mega-electronvolt
GHz	gigahertz	nm	nanometer	keV	kilo-electronvolt
MHz	megahertz	μm	micron		
kHz	kilohertz	cm	centimeter		
		km	kilometer		

2.2.2.2. *The energy grain*

However, a small phenomenon has appeared and raised doubt in peoples' minds and revolutionized our conception of light: the phenomenon is that of the photoelectric effect.

Some time will be spent on this development because it signifies the division between traditional and quantum physics. When a beam of monochrome light is sent onto a solid object, the solid object will only emit electrons from a certain frequency of this light. The interpretation, which was given by the famous physicist Albert Einstein, is that light carries its energy "E" by discrete packets which are proportional to its frequency " ν ": $E=h\nu$! These discrete packets are known as quanta, which give their name to the new area of physics known as quantum physics.

Just like the waves in optic microscopes with their properties of propagator interference and diffraction, light is also corpuscular. When we look at our world on a smaller scale, the idea of the continuous disappears and everything stops with ultimate countable quantities. An example of this would be if you look at an image in a newspaper. If the photo is enlarged, dots, which are the final component of the printing process, will be visible. These dots are obviously still part of the traditional world and correspond to the resolution of the image. If the image is enlarged again there is no doubt that ink molecules will be found and in this instance we are dealing with the nanoworld.

The nature of the photon is, however, very different to that of the electron. First of all, it has zero mass, it travels at a speed that particles with mass cannot even dream of reaching, and it can travel in a group in the same energy state. Therefore, photons can be stacked together in any number in the same space. This last property is the basis of the laser effect: a laser beam is in fact made up of photons of the same type, meaning the same energy.

Physicists talk about different families; remember that the electron belongs to the fermion family and the photon belongs to the boson family. We, as humans, are closer to the fermion family!

Let us come back to the photoelectric effect. We know that the energy of electrons varies under a discontinuous form, or to be precise, it occupies specific predefined states of energy.

In order to change state, in this case moving from one energy level in a specific material to an energy level in a vacuum, a single grain of energy is required. This corresponds to the difference in level from where the threshold (the minimum level of energy required in order to pass to the next level) appears. Generally, all interactions between electrons and photons are quantified, thus giving rise to the phenomenon of luminescence that can be seen in the nanoworld, particularly in the area of imagery.

The corpuscular concept enables us to have a better understanding of why ultraviolet rays and X-rays are dangerous. The photons which make up these rays are projectiles whose energy destroys our cells.

The quantum nature of the photon is used in a spectacular way in protecting confidential information.

In order to ensure communication security, man has always invented very elaborate coding systems; this is known as cryptography. Unfortunately, because of the power of calculation in modern computers, the codes always end up being cracked due to the fact that they are primarily based on arithmetic. This is especially evident in the world of banking where there is always a need for more sophisticated coding.

With photons, a new type of cryptography is starting to appear, especially in state-of-the-art laboratories which have very sophisticated instruments; this is known as quantum cryptography. This is based on the absolute ban on reproduction, which means that it is impossible to copy information. In the quantum world, measuring devices change the quantity of the measured object, so, if we measure a given state of a photon, we then transform it. It is like a locksmith who sees the lock change every time he tries to put the key in it.

This new method is imperative as it is the definitive weapon against theft.

Other uses of photons, which would be worthy of science fiction, are already up most scientists' sleeves.

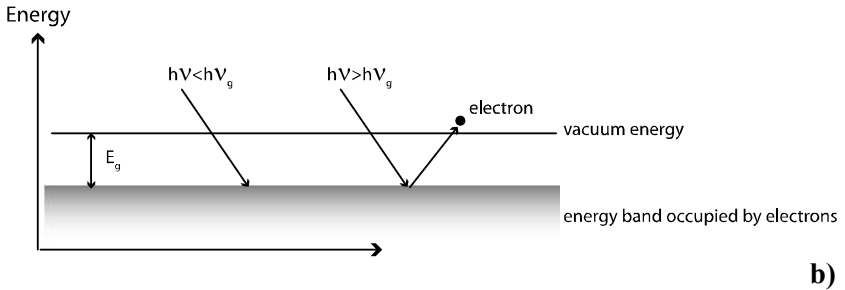
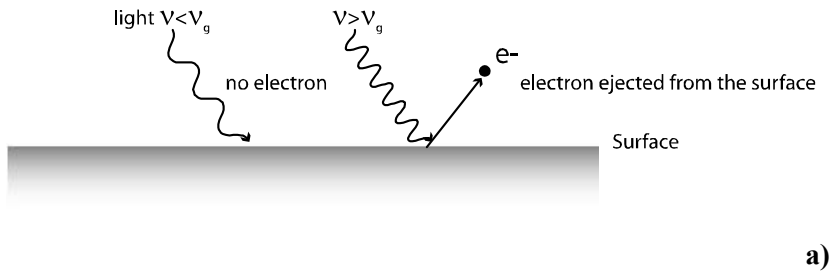

Figure 2.5. *The photoelectric effect*

a) Experience. While the surface of a metal vacuum is illuminated with monochrome light, the surface will emit electrons if its frequency ν is more than a certain value ν_g .

b) Physics. Light is made up of energy photons $E = h\nu$. While $E < E_g$ (E_g being the electron bond in the metal), the electrons will not reach the necessary energy level to break the vacuum in order to be able to escape. While $E > E_g$, the electrons are emitted by the surface.

2.3. Molecules

From atoms to molecular self-assembly, we are witnessing the continual emergence of new properties.

The most complex edifices, ie molecules, are organized by the grouping together of atoms. It is the properties of these molecules that give us the world in which we evolve.

In fact, the grouping of atoms reveals the notion of functionality; from acid carrying hydrogen with one atom, up to large molecules in living organisms, genes and long chains of molecules assembled in a helix. The latter carries the building blocks of living organisms² which are not only present in the nanoworld but also in our world.

2.3.1. From the smallest molecule to the largest and their spectacular properties

The water molecule: H₂O

The extraordinary subtlety of the hydrogen bond means that humanity is unable to work out the different characteristics of its phases; for example, a liquid which solidifies itself into an ice crystal is less dense than water. Water is necessary for life on earth. Another example is a solid snow structure whose infinite complexity allows researchers to carry out up-to-date research in order to optimize the friction coefficient. We are witnessing the emergence of new properties which are replacing those of their

² In a time when we can save hours of music onto an MP3 player, would it not be easier to imagine our life coded on one giant molecule? We could then believe we come from spontaneous creation or from homonculus, ie miniature versions of man that alchemists once pretended they were able to create.

atomic components. This will be the same for structures with an increasing complexity.

Proteins

These molecules, which have enormous edifices with multiple configurations and functions, have developed a soft chemical catalyst by using the lock and key effect to interact. Here, an atom has its own unique place: carbon, which has four electrons in its outer shell (a half-full shell), is at the heart of the chemistry of living things along with hydrogen, oxygen, nitrogen, and some other elements. The atom is at the origin of the extraordinary variety of proteins which replicate themselves, join together, construct and deconstruct.

Carbon nanotubes

These new objects, which are between the size of a molecule and an aggregate, will perhaps replace silicon which is the current leader in the world of electronics.

2.3.2. *Functionality*

The notion of functionality is fundamental. With bricks we can build a house; however, we can no longer see the individual components that make up the house once it is complete. In general, we are unable to predict the functionalities of a new molecule. When possible, a step-by-step construction of the molecule lets chemists work out its properties, at least in theory. If this is not possible, then the properties are discovered by trial and error, as is the case most of the time.

However, simulation, which is an extremely powerful approach based on the use of computers with advanced calculating capabilities and on the possibilities of unlimited information storage, has come to our rescue. This will be discussed later in this chapter.

2.4. Solid matter

After molecules, another important construction is that of solid bodies, some of which have a particular status in the nanoworld. How can we consider an atomic aggregate of several nanometers in diameter to be an insulator or conductor with the magnetic and electrical properties according to size? First of all, we need to understand the behavior of the electron in solids when affected by external factors which is the case for crystalline bodies. After this, we will be able to analyze the effect of the size of the aggregates.

Whether the solid is an insulator, conductor or semi-conductor, everything depends on the circulation of electrons within it.

2.4.1. *Insulators or conductors*

The fact that a body is an insulator or a conductor is only the consequence of the electron's ability to move.

Let us take the example of an insulating material. It has no free electrons because they are all taking part in interatomic bonds. One particular class of insulator corresponds to transparent bodies. All the electrons are so tightly packed together that the luminous photons do not have enough energy to unlock them and the light travels through the solid body without being absorbed, as in the

case of glass (silicon oxide) or diamonds (covalent crystal of carbon).

On the other hand, metal is a conducting material. Its properties can be described in a relatively simple way by considering it as a “box” with free electrons. This “box” is made up of atoms of ionized metal that are positively charged. The resistance characterizes the shocks of the electrons with the ions, which increases with thermal agitation and therefore the temperature. Knowing that there is one electron for one ion, the density of electrons is very large and therefore the current is important. In the case of aggregates, where the number of atoms and therefore electrons is reduced, we start to notice the individual behavior of the electrons, for example in surface interactions which give particular optic properties. Without being fully aware of its properties, ancient glassmakers used gold dust to color glass.

2.4.2. *Semi-conductors*

One particular item is essential for solid-state electronics and that is semi-conductors. They conduct electricity, but in a weaker way than a metal does. They allow for the manufacturing of components, such as the famous chip.

2.4.2.1. Silicon crystal

If we look at what happens in a crystal such as silicon, we notice that the silicon atom has, like germanium, four electrons on its outer shell; therefore it has four possible bonds. In silicon crystal, each atom is surrounded by four others and all the available electrons are used in the bonding process; no electrons can be free to participate in conduction. The crystal is therefore an insulator.

Let us then introduce some phosphorus into the silicon crystal in a weak concentration (doping is the term used when referring to semi-conductors). One phosphorus atom per million is a weak doping and one phosphorus atom per thousand is a strong doping. The phosphorus atoms randomly take the place of the silicon atoms without disrupting the crystalline lattice. The silicon crystal now becomes a conductor. Why? The phosphorus atom has five electrons on its outer shell, of which four are used to bond with their four neighboring atoms. The fifth electron is free and is only slightly held back by its original atom whose outer layer has eight electrons and is therefore saturated. It can consequently move within the crystal. We talk about n-type conduction (n for negative) and n-type silicon where the current is electronic.

Now let us see what happens when we introduce a weak concentration of indium atoms into the silicon crystal. They will also randomly take the place of the silicon atoms. In this case, the crystal also becomes a conductor. Yet the indium atom only has three outer electrons which are all used in the bonding process. However, one bond is not paired and an electron from a neighboring atom is able to come and make a pair with the remaining indium atom (there is no need for energy) to leave a partially unoccupied bond. The electron that moves leaves an equal and opposing charge and we can consider this conduction as the movement of a positive hole. We talk about p-type conduction and p-type silicon.

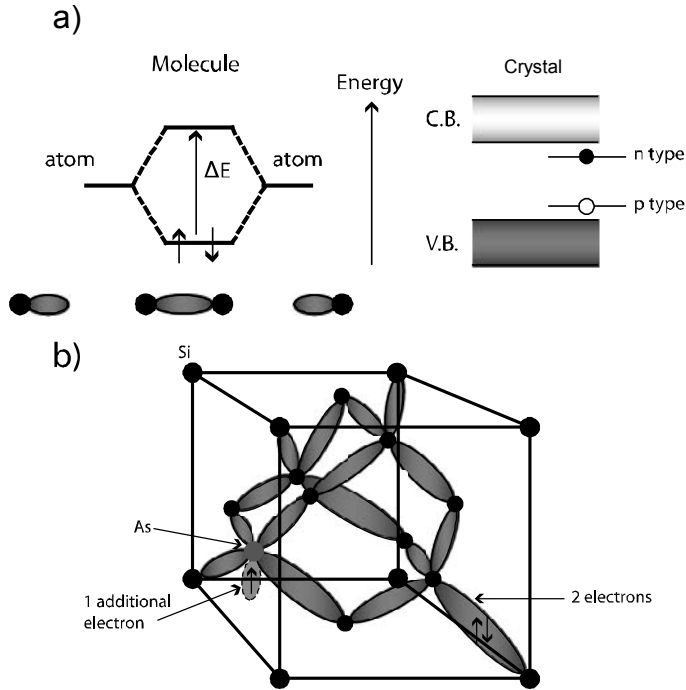

Figure 2.6. Molecular orbitals and the band structure of crystalline silicon

a) The chemical bond between two atoms is due to the joining of two electrons on a molecular orbital created by the interaction. The orbital possesses two energy levels, bonding and anti-bonding, separated by an energy ΔE . In a solid, these levels widen to become bands, the valence band (VB) and the conduction band (CB) respectively.

b) For silicon (Si) which has four electrons on its outer shell, each electron bonds with one of the four neighboring atoms in the crystal. All the electrons take part in the bonding process. Thus, the valence band is full and there is no possible displacement of charge.

If a silicon atom is replaced by an atom from column 5 of the periodic table, such as arsenic (As), the fifth electron is weakly bonded and passes to the conduction band. The silicon crystal becomes a n-type conductor. If a silicon atom is replaced by an atom from column 3, there is an electron missing. This creates a hole which lets an electron move into the valence band. The silicon crystal becomes a p-type conductor.

2.4.2.2. *Electrons and holes*

A simple representation of the concept of hole conduction can be created with the following analogy. We are driving on a road and if there are not many of people on the road then it is not difficult to get from one place to another; there is enough space for everyone. If there is a lot of traffic, our movement is then dependent on the number of available spaces. This image lets us understand the idea of hole conduction.

If we observe a large crowd of people, where one free place in the crowd allows gradual movement, movement appears to occur as if the “holes” travel in the opposite direction of the people who use them in order to move forward, as is the case for bubbles that rise in a liquid and represent the displacement towards the bottom of the corresponding liquid.

2.4.2.3. *Junctions*

When a n-type silicon comes into contact with a p-type silicon, they form what is known as a junction. The current can only pass in one direction. In fact, if we look at it in terms of energy, the electrons from the “n” side do not have the same energy as those from the “p” side; these latter electrons take part in the bonding process and are strongly bonded in the crystalline lattice. The “n” electrons, which are free, are now more energetic. What happened to their contact? What happens when we try to join two liquid bodies of two different levels? What happens is that there is a flow of one into the other. But here, the liquid is electrically charged, and the passage of the electrons from the “n” crystal to the “p” crystal leads to the appearance of a difference in potential which balances the system. This is equal to the energy difference in volts of the banded-electron linked to the free electron states as is the case for silicon. If we directly polarize the atom, where the negative pole is on the “n”, then the current will flow. As a consequence, the “n” and “p” parts of a crystal automatically

isolate themselves, which is a property used in semi-conductor components.

On the basis of these components, technology lets us engrave billions of microscopic transistors together on the same plate, which when appropriately organized helps us create microprocessors.

2.4.3. *Nanomaterials*

As is the case with metals, we can produce structures with one, two or three nanometric dimensions. The most common structures are thin layers whose different production techniques enable us to precisely control the depth of the layer, measured in nanometers. Two examples include the self-cleaning surfaces of spectacles (the lotus effect) and silver bactericidal nanocatalysts in certain washing machines.

On this level, purely quantum effects will arise. We are talking about metamaterials, quantum wells, and other remarkable objects which are fascinating scientists, and becoming more and more a part of our daily life.

2.5. Quantum boxes: between the atom and the crystal

The spherical, semi-conductor nanocrystal atoms, ranging in size from 2 to 50 nm (nanometers), also called quantum boxes or quantum dots, have intermediary properties between those of a molecule and a solid. The electron's energy is no longer spread out in bands of energy as in an ordinary semi-conductor, but in discrete, quantified levels as in an atom or in a molecule. The distribution of energy on these levels is relative to the size of the crystal. It results in the fact that the wavelength from the light source, which corresponds to the relative recombination of these

pseudo atoms under excitation, can be adjusted in the visible domain. This technique is largely used in the medical world where nanocrystals are used as fluorescent markers. We find a similar explanation for quantum well lasers.

2.6. Some bonus material for physicists

Let us now address the laser effect. What does laser mean? Laser stands for Light Amplification by Stimulated Emission of Radiation.

A laser is a common, visible object: from blackboard pointers to disco lights, we recognize lasers because they have a perfectly defined color – they are monochrome – and because the beams are straight. Their rays diverge much less than a normal projector.

The qualities mentioned above are linked because we use the properties of a cavity³ in order to amplify and monochromatize the light. This light is normally emitted spontaneously from certain materials by the fundamental process of luminescence.

2.6.1. *Luminescence*

We have seen that electrons in an atom occupy a clearly defined state of energy. In their basic state, they occupy the electronic state with the lowest energy. If we put an electron into a superior electronic state, it becomes excited. Very quickly it will become de-excited by emitting energy.

³ This cavity in the optical world of electromagnetic waves is analog in the field of acoustics: a resonance cavity amplifies sound waves corresponding to stationary waves. This resonance cavity is fixed by the dimensions and shapes of the musical instruments.

In an atom, the energy exchanges are carried out by photons. Excitation and de-excitation correspond to the absorption and emission of a photon respectively during energy exchanges between two different energy states. The emission is completed either spontaneously or by stimulation by the photons themselves following an entrainment process. There cannot be any amplification in this case since the more the atom becomes excited, the more it will become de-excited. At most, we have a balance between the atoms in their basic state and in their excited state.

Let us now consider a system with three states of energy: the basic electronic state F and two excited electronic states with superior energy, $E1$ and $E2$, with $E2$ having more energy than $E1$. We excite an electron so that it can pass into the $E2$ state. It comes back to its basic state by either directly emitting a photon of the same energy as what it has absorbed, or “in cascade”, by passing through the intermediary level $E1$. In the second case, it emits two photons whose additional energy corresponds to the unique energy of the direct transition. The excited electron has the choice between these two mechanisms. If the transit via the intermediary level $E1$ is the quickest path, then it is clear that this is the path that will be taken by the electron.

This is what happens to certain atoms when they are introduced into solid bodies. The first, most commonly known example is chromium when it is introduced into an alumina lattice, which gives us rubies. It absorbs green light (transition A: from the basic state F to the superior excited state $E2$) and emits red light (transition E: from the intermediary state $E1$ to the basic state F).

This emission technique can be explained in the following way: the chromium atom is not isolated and the transition from the superior excited state $E2$ towards the intermediary is influenced by the presence of the lattice. In effect, the $E2$ level corresponds to a state far from the nucleus of the chromium atom and it mixes with the states of neighboring atoms. It results in the fact that this level is no longer a purely atomic level; it acquires a wider energy band.

Furthermore, the transition towards the E1 level is a lot faster than the direct transition to the basic state, and is carried out by a non-radiation process producing heat.

This technique is essential because we have the possibility, by using green light, of having more atoms in the excited state than in the basic state during the lifetime of the E1 state, which is not subject to the absorbed photons by the E2 state. This phenomenon is known as population inversion. An amplification of light in this case is possible: for red light, the absorption is weaker than the stimulated emission that it will lead to, thus the laser effect is attained.

2.6.2. The laser device

If the amplifying medium is placed between two parallel mirrors forming a resonant cavity, then the red light will spontaneously release itself by auto-stimulation. The coherent stimulated amplification is then made by following a type of resonance which creates a very monochrome and guided beam of light following the axis of the cavity; the cavity being the mirror which is slightly transparent. We now have the laser effect.

Many other materials that possess light-emitting centers are used to create lasers of different wavelengths. If we continue the permanent excitation of atoms, or optical pumping, we have continuous wave lasers. If the excitation comes from a flash source, then we have a pulse laser.

Semi-conductor lasers function in a different way: luminescence occurs when the recombination of electrons and holes on the “pn” junction level is radiative, which is the case for certain materials such as gallium arsenide. Strictly speaking, this junction has to be directly polarized when we want to emit light. We produce electroluminescent diodes and semi-conductor lasers using the

same techniques that are used in microelectronics. Thus, at present we are able to develop hybrid circuits integrating lasers on silicon circuits, mainly for use in the world of telecommunications.

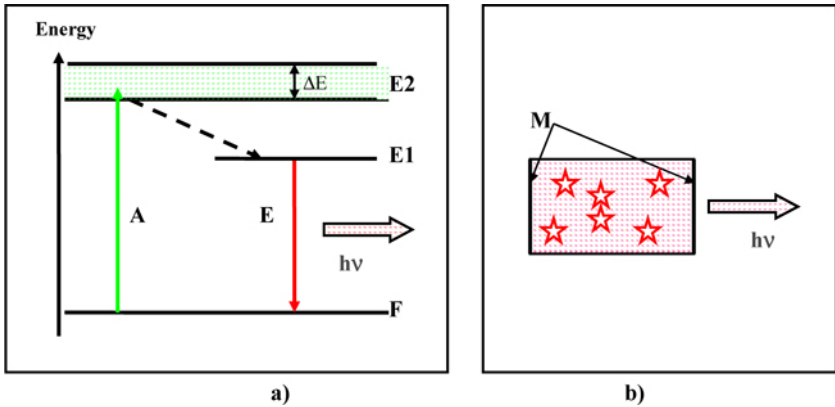

Figure 2.7. Light-emitting diodes and lasers: general principles

a) The electron of a light-emitting source, for example the ion Cr^{+3} , in the aluminum matrix for a ruby laser is excited from its basic structure F up to a state of energy E2 width ΔE (absorption band). It quickly passes to the discrete state E1 by losing its energy in a non-radiative way.

b) The lifetime in the E1 state lets us keep a majority of electrons in this excited state during a strong illumination in the absorption band (optical pumping A). We also say that there is a population inversion. This system collectively de-excites itself by stimulation (the emission of energy $E = h\nu$). If the material is placed in a resonant cavity with parallel mirrors (M), known as a Perrot-Fabry cavity, then the emission takes place in the form of a very thin ray (cavity resonance mode), and leaves through the semi-transparent mirror following a beam of light parallel to the axis of the cavity. There are three characteristics for laser lighting: monochromaticity, phase coherence, and directivity.

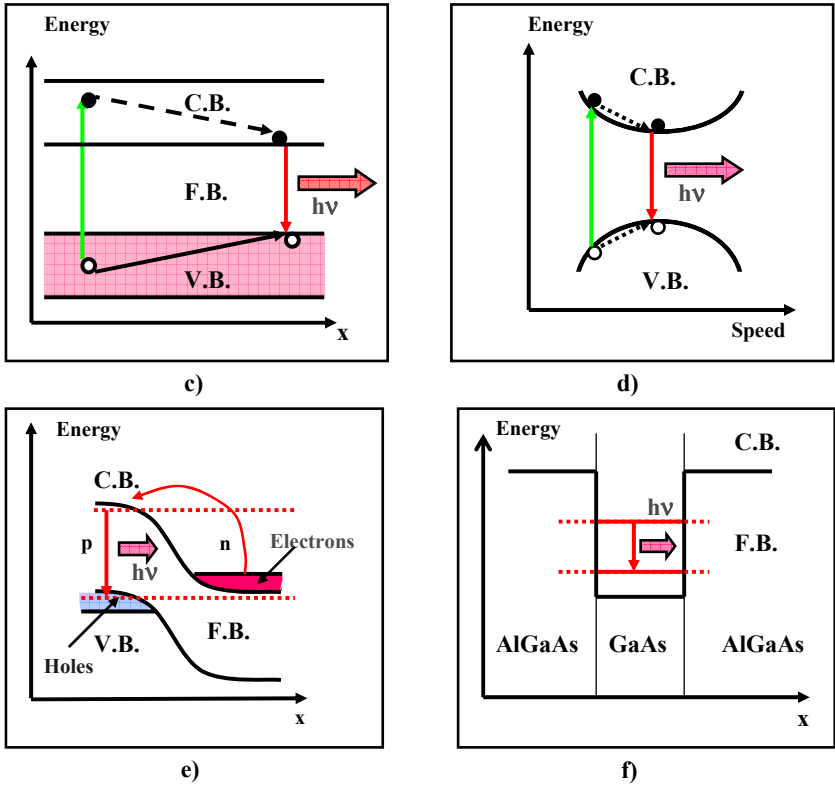

Figure 2.8. Semi-conductor lasers

c) Diagram of a band. The valence band (VB), the forbidden band (FB) and the conduction band (CB). An electron is excited and passes into the conduction band. It immediately relaxes with the minimum energy of the conduction band. Furthermore, the hole that it leaves relaxes at the top of the valence band, otherwise known as the minimum energy principle, which is always used by electrons. The electron comes back to its basic state by emitting a photon of energy $h\nu$.

d) The coordinate representation of the speeds of electrons. A radiative transition can only take place if the minimum conduction band corresponds to the maximum valence band, which is the case for the majority of III-V composites (elements from groups 3 and 5 of the periodic table) such as

GaAs (Gallium Arsenide). We say that the semi-conductor is a direct gap semi-conductor⁴.

e) Representation of the emission technique in a “pn” junction. Strictly speaking, electrical excitation takes place in a direct polarized junction by the introduction of carriers: electrons from the conduction band “n” recombine at the junction with the holes from the valence band “p”. By altering the make up of composite compounds, we can adjust the emitting wavelength by changing the width of the forbidden band. A multitude of different types of more or less sophisticated light emitting diodes (LEDs) are produced using this technology. When the structure of the diode is a Perrot-Fabry cavity we have a laser diode.

f) Quantum wells. These are created with compatible materials from different forbidden bands. When the thickness of the shell is nanometers deep and the shell is sandwiched between the shells of more important forbidden bands (example: AlGaAs/GaAs/AlGaAs) then we see atomic pseudo-states starting to appear just as in quantum boxes, giving rise to a new type of quantum optoelectronics.

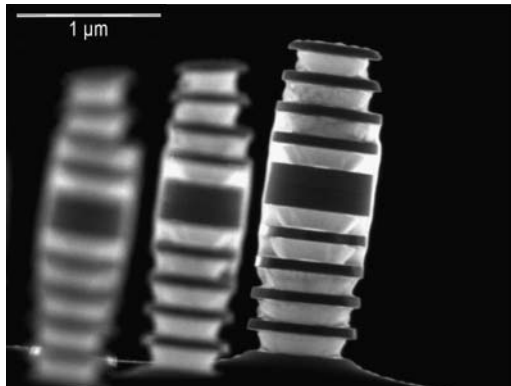

Figure 2.9. *Quantum dot for single photon experiments: 400-nm-diam micropillar, produced by e-beam lithography and reactive ion etching from a GaAs/AlAs-layered planar structure grown by molecular-beam epitaxy*

4 The emission of a photon that has zero mass occurs without any variation in the momentum of the electron. Momentum is the product of the mass and the velocity (v). The minimum value of CB and the maximum value of VB must correspond to the same value of v , which is the vertical transition on diagram d.

The theory of symmetry groups

From the atom, and indeed from the subatomic to the solid, the theory of symmetry groups gives a powerful definition of the above listed areas of science and can be easily adapted to the quantum world.

It is based on operator algebra. For example, the “rotation” operator (R) enables us to rotate a body. If the body is of spherical symmetry any type of rotation transforms the body in itself. The particular states of this operator⁵ are well known mathematically; they are known as spherical harmonics.

As far as the atom is concerned, its electrons occupy defined states of symmetry using the coulomb potential. The operator that lets us calculate the energy of the states is known as the Hamiltonian (H). It is clear that the energy from the atom is independent of any geometric rotation that we can subject it to, which translates mathematically by the fact that the operators R and H can switch places with one another. This means that we can apply the two operators in one state in any order so that $RH = HR$ for the same result.

In operator algebra, an important theory states that when two operators commute they have the same basic functions. The particular states of the rotation operator therefore create a basis for the quantum states of the atom, which in turn explain the distribution into successive layers and all the quantum numbers of the electronic states. This is truly amazing.

⁵ In algebra, an operator is an application that transforms one function into another function. It is represented by a matrix in a space called a vectorial. The particular states correspond to base vectors in which the shape of the matrix is diagonal. For atoms, the particular states represent independent states that the electrons will occupy.

In a periodic solid, the application of the “conservation law of momentum” from the electron to the operator of translation gives the functional shape of the quantum state waves, the famous Bloch functions and band theories. We cannot really say anything more; all we can do is admire a theory based on a fundamental concept, that of symmetry. When theory becomes a work of art it almost resembles poetry: “There’ll be nothing but beauty, wealth, pleasure, with all things in order and measure”⁶.

6 “L’invitation au voyage” in *Les Fleurs du mal*, Charles Baudelaire (English translation by Roy Campbell, *Poems of Baudelaire*, 1952, New York: Pantheon Books).

This page intentionally left blank

Chapter 3

The Revolution in Techniques Used in Observation and Imagery

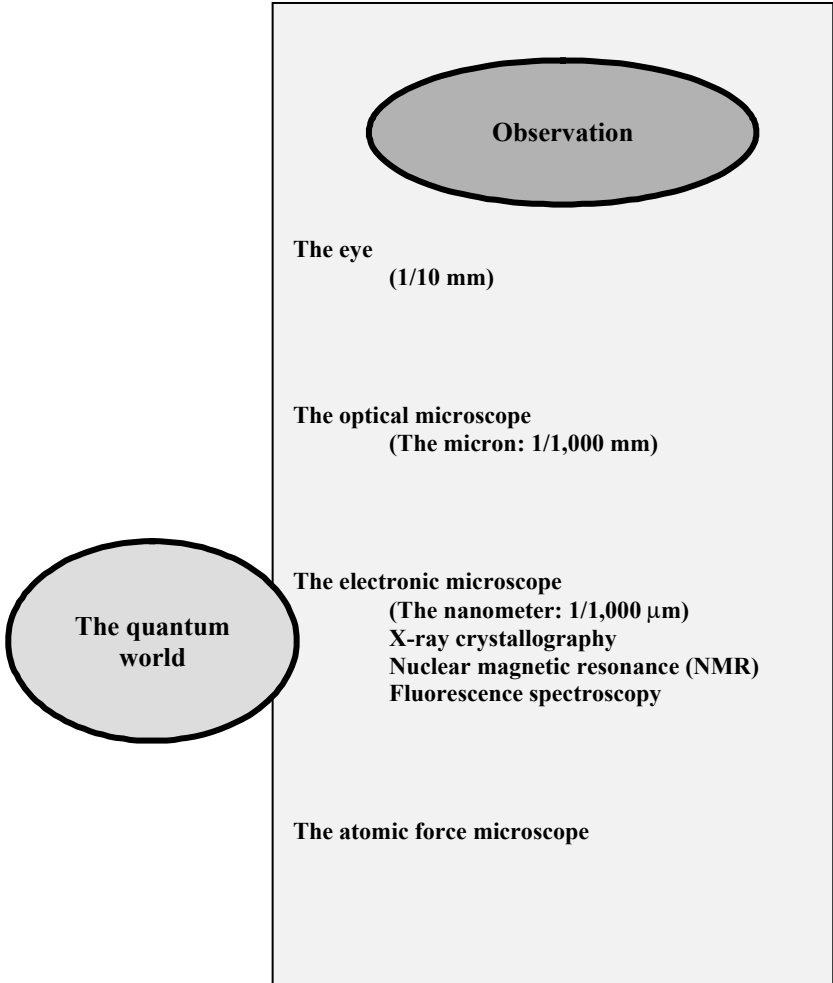

Observation is at the origin of all scientific discoveries.

The nanoworld is becoming more important and is even becoming an area of scientific discovery thanks to the progress that has been made in the techniques of observation.

3.1. Observing with photons

3.1.1. *The optical microscope in visible light*

The optical microscope was the first instrument that enabled man to observe objects normally invisible to the naked eye. As the microscope is subject to the laws of optics, its resolution is limited to several tenths of a micron. In order to study samples from living organisms, the samples must be prepared with coloration techniques.

A new generation of microscope which uses laser light appeared in the 1980s. It has enabled scientists to create three-dimensional images at different levels of depth of the matter being studied by using focalization and laser beam scanning. This type of microscope is known as a confocal microscope¹ and is particularly adapted for use in the natural world.

One very interesting use of these microscopes corresponds to their ability to work with fluorescent markers. The laser beam excites a fluorescent substance which has been added to the sample, for which we know the affinity for certain molecular sites. Thanks to these markers we can, for example, selectively view certain reactions. The fluorescent signals are detected by electronic

¹ A diaphragm situated in the focal plane image of the microscope only detects the photons coming from the convergence point of excitation, in other words the focal plane object.

sensors and these signals are then amplified. The image is then processed by computer.

3.1.2. *X-ray machines*

X-rays are photons with a wavelength that is much shorter than the wavelength of ultraviolet light. X-rays are produced from an accelerated shock of electrons against a metallic target.

One of the first applications of machines using X-rays was in the macroscopic domain. The X-rays benefit from the fact that this radiation has a strong penetrating power in materials with the rate of absorption depending on the density of the material. Radiation transmitted through a body coated with a phosphorescent or photosensitive substance is commonly known as radio waves. A sophisticated version of this type of machine is the X-ray scanner. The transmitter turns around the object at the same time as the receptor does, measuring the intensity of the X-rays transmitted. The data is processed by a computer which reconstructs cross-sections of the object, in other words 3-D imagery. The resolution is determined by the quality of the X-ray beam used. This type of machine is used in many applications, especially in medical imagery.

Another type of machine, which uses the interactive properties of X-rays with crystalline structures, is used in X-ray spectroscopy. These machines enable scientists to investigate objects in the nanoworld. Their operation rests on the following principle: a crystal is made up of identical patterns of atoms following a particular lattice whose chain is the same size as the wavelength of the X-ray. The X-rays are realigned by selective reflection in predetermined directions and then form diffraction figures. The information contained in the diffraction figures clearly deals with the structure of the lattice and, more specifically, the rather complex three-dimensional structures of atomic patterns. This

analysis is possible, firstly, due to the quality of today's machines and, secondly, because of the sophisticated calculation techniques used. This type of machine is an essential tool for chemists who want to assemble molecules in crystalline form in order to study their atomic pattern. This method enabled the discovery of the double helix by Francis Crick and James Watson in 1953².

3.2. Observing with electrons

Electron microscopy uses the wave properties of electrons. However, as particles they need a vacuum in order to travel. Microscopes are in the form of a metal vacuum enclosure in which the following can be found:

- The electron gun, such as in cathode ray tubes used in television sets.

- The different elements of electronic optics, such as electromagnetic lenses (equivalent to traditional optic lenses) which control the trajectories of the electrons as well as the support of the object to be studied.

There are two types of electron microscope.

3.2.1. *The transmission electron microscope (TEM)*

In this type of microscope, as with X-rays, the beam interacts with the crystalline sample and creates a diffraction figure, or hologram. The analysis of the diffraction figure enables us to study the atomic structure of the sample being analyzed. The final resolution is related to the associated wavelength of the electrons

² This discovery won them the Nobel Prize for Medicine in 1962.

and therefore to their energy. The most powerful machines work with voltages in the region of hundreds of thousands of volts.

3.2.2. *The scanning electron microscope (SEM)*

The surface of the sample under study is scanned with an electron beam. The size of the scanned surface depends on the level of enlargement desired. The interaction between the electrons and the sample gives rise to different signals (the emission of electrons and photons) which when gathered and analyzed bring together the image of the surface of the observed sample without using any mathematical process, contrary to the process of the TEM.

The resolution of this type of instrument, limited by the machine's technology, enables scientists to view objects at an atomic scale (1/10 of a nanometer).

A significant restriction of this microscope, as is the case for the TEM, is that it needs a vacuum. The samples need to be prepared in a specific manner, in other words they need to be plated, cooled, and cut into thin sections, all of which are clearly impossible when observing living organisms.

A new generation of SEM has overcome this restriction; they are known as environmental scanning electron microscopes. These SEMs enable scientists to observe objects in their natural state. The difference between the environmental scanning electron microscope and the conventional ones, which need a high vacuum on all levels of the columns that make up the microscope, is that the sample remains at a determined pressure thanks to a differential diaphragm pump system used in the observation room.



Figure 3.1. *The environmental scanning electron microscope:*
a) *a general view of the environmental scanning electron microscope,*
b) *example: detailed makeup of the eye of a drosophila*

3.3. Touching the atoms

The atomic microscope is mainly used in research laboratories. It works on a simple principle, but with very sophisticated technology.

Scientists create an image of vertical displacement from a point on the surface of a sample. This point is made up of some atoms (eg thinned down tungsten microcrystal atoms) and the precision of displacement is to the nearest 1/10 of a nanometer.

In the first version invented by IBM researchers³ in 1981, the control signal is the current, albeit extremely weak, existing between the point of the microscope and the surface of the sample without any contact between the microscope and the sample. However, they are at a distance where the electrons can pass through by using the tunnel effect. In this case, we are referring to the scanning-tunneling microscope.

When there is contact between the point of the microscope and the surface of the sample, the microscope is called an atomic force microscope. This is the nano equivalent of our old gramophones. This type of microscope enables scientists to analyze surfaces with insulating properties, which is impossible with the scanning-tunneling microscope.

An optical version has existed for a short time now, and it is based on the presence of an optical wave that does not move. This evanescent wave is present on the illuminated surface of a sample which can only be detected on a nanoscopic level.

With these instruments, scientists can see the atoms of a surface, but they can also use these instruments to move the atoms, form

³ Gerd Binnig and Heinrich Rohrer, Nobel Prize winners for Physics in 1986.

aggregates and construct atomic objects in order to study the properties of the atoms.

New generations of microscopes are being created which enable scientists to work on both the atomic and molecular scale.

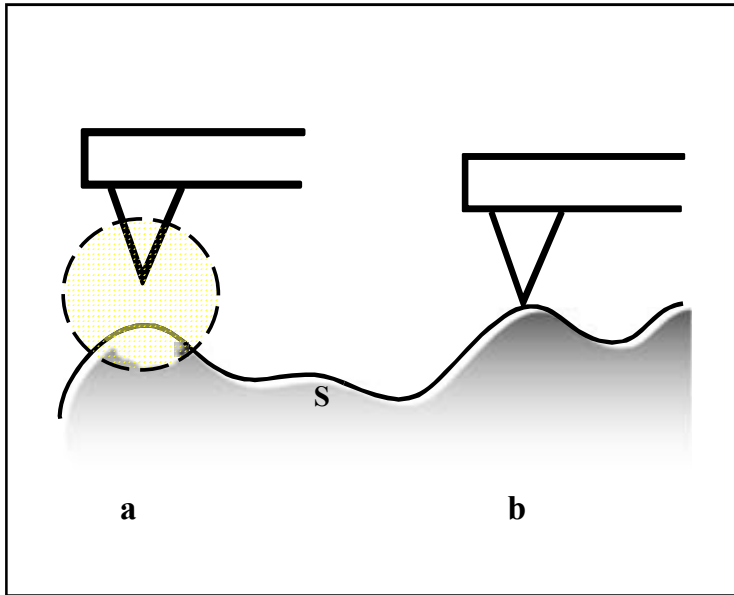

Figure 3.2. *The principle of atomic microscopes*

a) The scanning-tunneling microscope. Electrical charges pass from the surface of an object to the point of the microscope without there being any contact. The current varies strongly with distance. The movement of the point of the microscope is controlled with a specific current value in order to follow exactly the surface of the sample.

b) The atomic force microscope. A derivative of the scanning-tunneling microscope, it enables scientists to study the insulating surfaces. There is contact between the point of the microscope and the surface. The control is regulated by the force of pressure.

3.4. Observing how our brain functions

3.4.1. *Nuclear magnetic resonance*

A new generation of machine, primarily used by chemists, is becoming increasingly important in the field of medicine because it allows for 3-D imagery inside the organism. It uses nuclear magnetic resonance.

Remember that the proton, which has a nucleus, can be considered as a small magnet with two states called spin-up and spin-down, just like the electron. Certain nuclei, according to the number of protons they have, possess a magnetic moment. The nucleus of the hydrogen atom, in other words its proton, is the probe that is the most used. In a magnetic field, the two spin states have different levels of energy. If the proton is subject to a radio-frequency electromagnetic field whose energy is equal to the difference of these two states, there will be a resonance mechanism producing a signal which may be detected. This signal depends on the proton's environment. This is in fact a preferred method used by scientists for organic chemistry analysis.

Nuclear magnetic resonance is used in medical imagery due to the fact that it is non-destructive and enables scientists to carry out 3-D investigations with a resolution that is actually comparable⁴ to X-ray scanners. The 3-D investigation is obtained by creating a magnetic field gradient in the body. The zone corresponding to the resonance of the protons of water molecules produces a signal at a determined frequency which is fixed by the nuclear magnetic resonance machine. The zone of resonance can be moved by varying the magnetic field.

⁴ The information obtained from these two methods is different.

The three-dimensional resolution is related to the frequency of resonance, and therefore to the intensity of the magnetic field which leads to the use of supra-conductor coils⁵ which are only capable of generating sufficient magnetic fields for large objects.

3.4.2. Functional magnetic resonance imaging

One extremely promising technique associated with nuclear magnetic resonance is functional magnetic resonance imaging (fMRI). This enables scientists to study how the brain works. The excitation of groups of neurons can be observed by the amplification of the resonance signal and the rise in blood flow which is caused by the increase in the metabolism of the neurons. Scientists are therefore able to see how the brain functions. This type of imagery is currently under development.

⁵ Supra-conductor coils are created with alloys which have a zero electric resistance at low temperature, allowing for considerable electric currents without any loss.

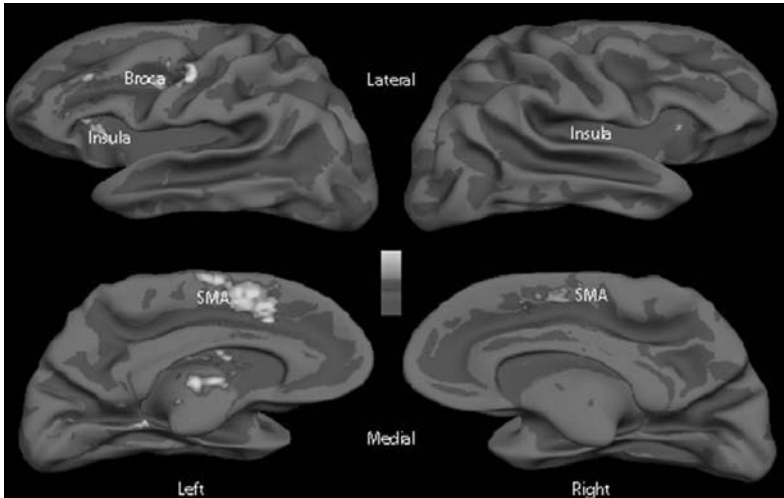

Figure 3.3. *Functional magnetic resonance imaging (fMRI)*

Application to functional imagery:

Activations obtained during the cognitive task. The anatomic image of the brain is represented here after cortical inflation allowing us to have a more detailed image of fissions or sulci (dark grey) and convolutions or gyri (light grey). The obtained activations, encoded according to a red-yellow color scale, highlight the neuronal fields involved in this task, primarily in the left hemisphere.

We have seen the main methods and observation tools that scientists use in order to study the nanoworld. Others exist which generally correspond to more sophisticated versions of the machines already described in this chapter. The use of nuclear technology in the field of medicine, such as the use of radio-isotopes, will not be discussed here.

3.5. Some bonus material for researchers

Synchrotron radiation involves the emission of light from electrons spinning in rotation.

In order to probe the nucleus of the atoms, physicists use electrons as projectiles in order to split them. To do this, the electrons are accelerated in order to supply them with energy. The first machines of this type were linear electrostatic accelerators which were replaced by more powerful ring-shaped instruments known as synchrotrons. The synchrotrons propel the electrons at speeds close to the speed of light⁶. A packet of electrons is introduced and each solo circuit receives supplementary energy. Unfortunately, at each turn the electrons lose energy by emitting electromagnetic radiation. This phenomenon limits the ultimate performance of the machine and, as a result, large machines have been created in order to minimize the loss of the electron's energy. An example is the large hadron collider which belongs to the European Organization for Nuclear Research whose 27 km circumference is larger than that of Geneva.

However, this light, which is undesirable for high energy physicists, has many exceptional properties.

Light is emitted during each rotation of the packets of electrons. Each beam of light possesses a continuous spectrum from infrared rays to X-rays.

Physicists, followed by chemists and then biologists, have been quick to use this source of light by "parasiting" certain accelerators. In France this is what is happening at the Laboratory for the Use of Electromagnetic Radiation (Laboratoire pour l'Utilisation du Rayonnement Electromagnétique (LURE)) in Orsay⁷. Some light lines have been altered which did not please

6 Speed limit impassable. The energy of a particle with a non-zero mass becomes infinite at this speed.

7 "LURE has completely fulfilled its mission as a national center of synchrotron radiation. Much has been achieved between its creation in October 1971 and the decision to create SOLEIL in September 2000. Its history is made up of many scientific and technological firsts, such as ground breaking experiments and the development of instruments and machines. [...] LURE contributed strongly to the

nuclear physicists who saw this as a type of parasiting of the light lines in order to please other scientists⁸.

Very quickly this source of intense light was put to use in multiple scientific fields. Here are two particular examples:

– The first is in the area of microelectronics, such as UV and X-ray sources, in order to push back the ultimate limits of lithography.

– The second is in the area of biology. Biochemists use an intense radiation of X-rays to enable them to carry out experiments that were previously impossible.

This new source of light was optimized and large machines dedicated to synchrotron radiation were created throughout the world. This is the case for SOLEIL in France.

Thus, a parasite light stemming from the theory of relativity and the physics of particles has become one of the most powerful instruments used to study matter on a nanometric scale.

creation, definition and defense of the more recent project known as SOLEIL.” Adieu LURE, Welcome to SOLEIL and CLIO-ELYSE. A message from A. Tadjeddine, Directing Manager of LURE, September 26, 2005.

⁸ The electrons spin millions of times on a stable trajectory to the nearest 1/10 of a millimeter in tubes which have an extremely tight vacuum. The use of the light emitted by the synchrotron needs vacuum drains linked to the ring in which the electrons spin.

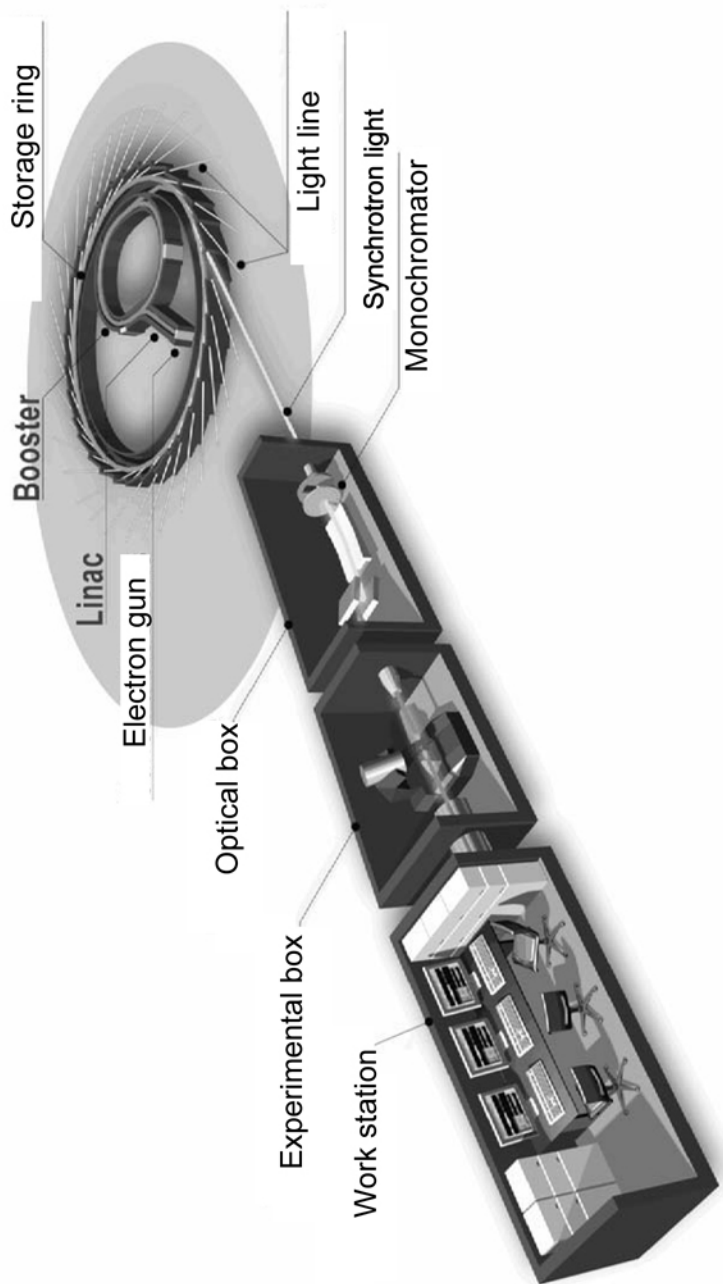

Figure 3.4. SOLEIL: a synchrotron in France. *Diagram of a light line*

Observation helps us see more clearly

Observation has always been the starting point in the progress made towards greater knowledge and mankind has invented instruments to study the infinitesimal, as well as the infinitely large.

Optic microscopy has made remarkable progress, in particular in the latest generation of confocal microscopes. 3-D images of the subject matter to be studied are obtained by the scanning of a laser beam whose absorption only occurs in sites where the frequency of excitation corresponds to twice the frequency of the light used. This property, called two-photon absorption, has two interesting points: first, the matter is transparent for one-photon absorption and, secondly, it only occurs at the focal point of a beam which provides excellent photographic detail. Two-photon laser scanning fluorescence microscopy, which is based on the same principle, is the most sophisticated method of microscopy that uses fluorescent markers.

A new generation of scanning electron microscopes, known as environmental scanning electron microscopes, makes it possible to study specimens without the preparations that are required for traditional electronic microscopy. These microscopes enable scientists to observe in vitro with a resolution of less than a nanometer.

The atomic microscope, which is only used in laboratories, is the best microscope used for the analysis of surfaces on a subnanometric scale.

Scanners using nuclear magnetic resonance have made extraordinary advances in medical imagery. MRIs continue to improve their resolution by using more intense magnetic fields.

To facilitate the observation process or to make it possible, coloration techniques are used. Biochemists have been using coloring or fluorescent substances for a long time in order to identify molecules, enabling their identification by absorption or fluorescence⁹. Molecular biology has also brought with it some innovations in this field, for example green fluorescent protein¹⁰. This molecular marker enables scientists to see the dynamics of proteins in the natural world. The techniques used to manipulate the molecules of living organisms can bind the molecules with fluorescent markers which act as real markers for the observation process. It is possible to selectively study how our molecular structures, proteins, repairing enzymes, and hormone signal transfers function.

Furthermore, nanoscience has made immense progress in imagery by controlling the fabrication of nanostructures, nanoparticles, and nanocrystals with a specific molecular fixation. Scientists can therefore appreciate the biological molecules of nanocrystals or quantum dots which have optic properties superior to those of fluorophores¹¹.

The cell lights up under our microscopes in the same way as a town does at night-time.

9 The emission of light under optic or electronic excitation.

10 This protein, which is extracted from the jellyfish, *Aequorea victoria*, is coded with a gene that can be introduced into the genome of a cell by genetic manipulation. We can genetically produce rabbits which glow fluorescent green under ultraviolet radiation.

11 The spherical nanocrystal is made up of atoms taken from groups 2–6 and groups 3–5 of the periodic table. This crystal is also made up of a packet of organic liquids.

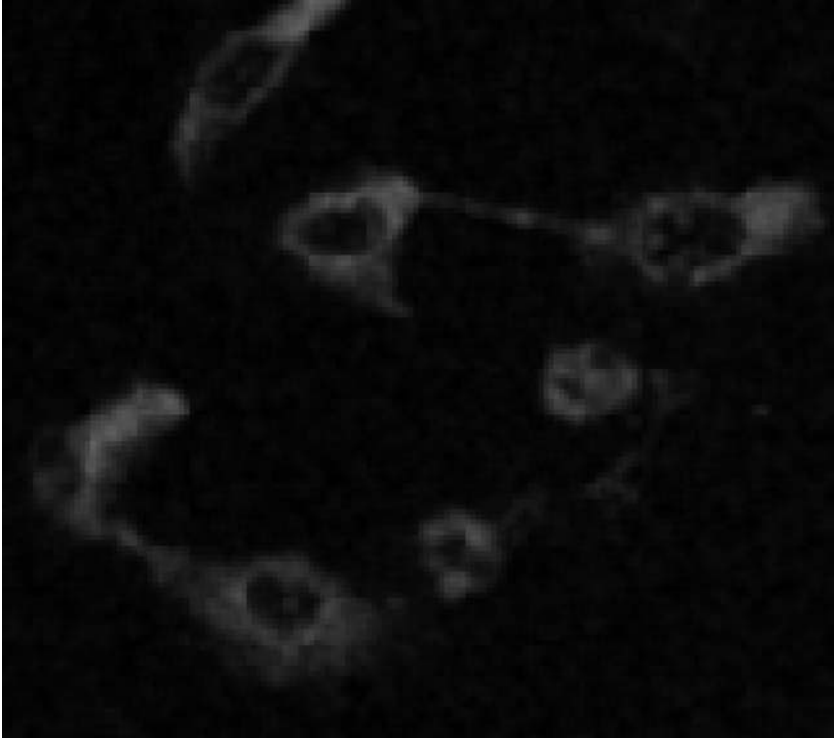
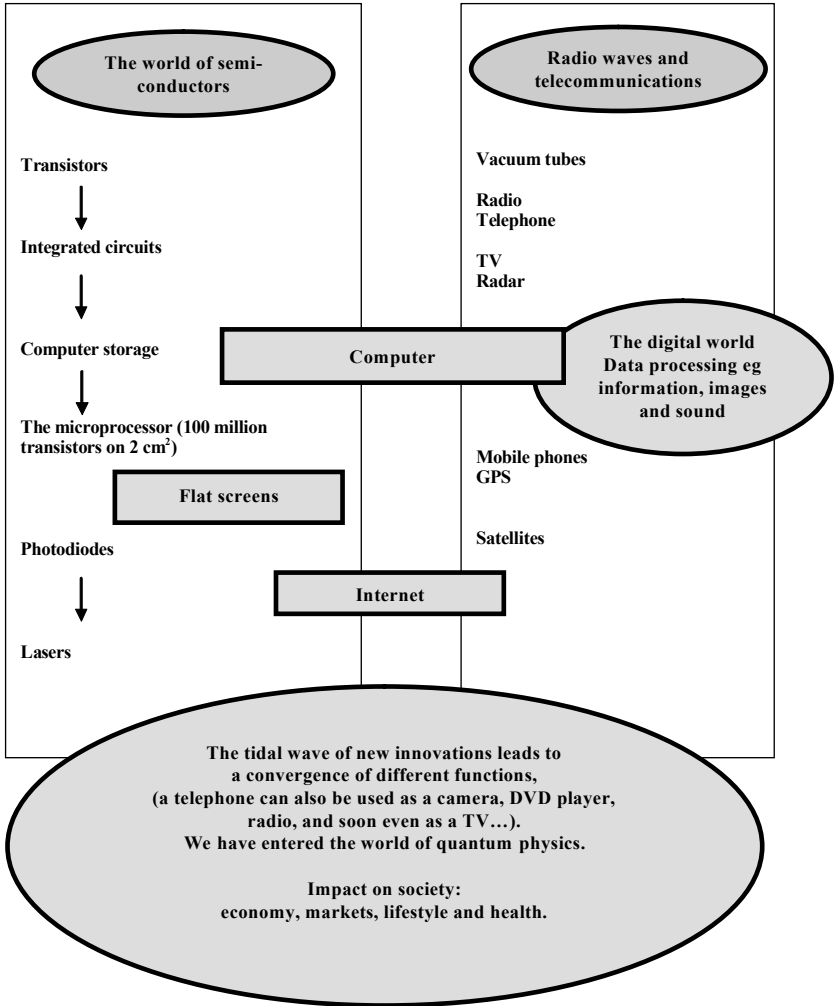

Figure 3.5. *Fluorescence imaging.*
This image represents fibroblasts which are found inside carbon nanotubes

Chapter 4

The Marriage of Software and Hardware *or Intelligence Engraved in Silicon*



In terms of size [of transistor] you can see that we're approaching the size of atoms which is a fundamental barrier, but it'll be two or three generations before we get that far but that's as far out as we've ever been able to see. We have another 10 to 20 years before we reach a fundamental limit. By then they'll be able to make bigger chips and have transistor budgets in the billions.

(Gordon Moore, Co-founder of Intel, 2005)

4.1. Small is beautiful

One way of reaching the nanoworld is by miniaturizing the objects of our world. This process is called top-down. The forerunner in this field is evidently microelectronics, now referred to as nanoelectronics. As the primary component in this field, the transistor becomes ever smaller. The consequences for the domain of information technology and telecommunications are tremendous. Furthermore, this scientific progress will enable the fabrication of billions of copies of this component. Being highly complex, reliable, energy-saving and in possession of gigantic memories, they could even be classed as the beginning of a form of intelligence. In order to produce these copies we need a very advanced scientific level and high-tech equipment. Obviously we cannot create a new neighborhood just by building houses next to one another. We need a structure, all sorts of networks and circuits that allow us to control the entire system. A microprocessor is really just a city in this sense, but reduced to the size of a pinhead.

4.2. Miniaturization

It took John Bardeen, William B. Shockley and Walter H. Brattain's (winners of the Nobel Prize for Physics in 1956) discovery of the transistor to begin the adventure. The electronic amplification device had previously been created with the help of

the triode¹ which could not be miniaturized and consumed high amounts of energy. Several thousands of these tubes were used to create the first electronic calculators, which needed a good 10 kWh to work.

This changed with the appearance of solid semi-conductors. Their size became ever smaller and has reached a tenth of a micron in today's production, and in the area of research these semi-conductors are even smaller. At the same time, the appearance of the binary numeral system for calculators and the development of computers enabled the rapid development of a new technology with an exceptionally high performance. This technology is based on Metal Oxide Semi-conductor Field Effect Transistor (MOSFET) and it made silicon the most important material in electronics. As all possible information is coded using the binary numeral system of 0 and 1, which could also be described as an on/off system, the MOS transistor is perfectly adapted to it. This transistor relies on an electric field which is applied to an electrode to control the shape and hence the conductivity of a channel. The same principle applies to water pipes in which the pressure controls the water flow. This kind of device is not the only one which exists, but due to its simplicity, its geometry, and its relatively easy production, it is the best suited to large scale integration.

4.3. Integration

4.3.1. *The silicon planet*

With relation to the fabrication of integrated circuits, we moved from LSI (Large Scale Integration, at the level of thousands of

¹ In this vacuum tube the heated filament (cathode) causes a flow of electrons that hits the plate, a positively charged electrode (anode). The anode will receive the electrons. A third electrode (wire grid), which is polarized more or less negatively, is placed between both of them and controls the flow of electrons.

transistors) on to ULSI (Ultra Large Scale Integration, at the level of millions of transistors). Producing a primary device is one thing, but integrating millions of transistors per square centimeter without any errors is something else. The smaller the devices, the bigger the factory producing these circuits. This is a consequence of scientific, technical and economic needs:

– Scientific needs: the smaller a device becomes, the less energy it consumes. This is essential if we want millions of these devices to work on a small surface and increase the frequency of operations carried out. Currently, integration still continues to follow Moore's Law.

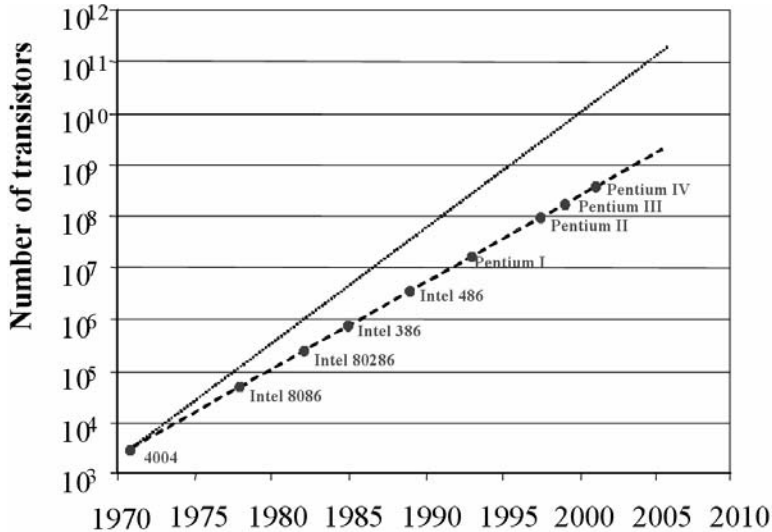

Figure 4.1. *Moore's Law*

– Technical needs: the smaller a device becomes, the more difficult its fabrication. In fact, it is essential that no problems occur that could interfere with the functioning of the device. A high level of integration forces all operations required in the creation of the final product to be exactly the same. The working environment

needs to be entirely dust-free; these are the so-called clean rooms where employees wear specialized clothing and all products used in the process need to be at a high level of purity.

– Economic needs: the smaller a device becomes, the higher the cost of production. A maximum amount of circuits therefore needs to be engraved on each circuit board so that the diameter increases. Currently the limit of the diameter lies at 30 centimeters. An economic balance can only be reached if the price of the machines is not too high. The photorepeater² exposes the synthetic resin in preparation for the process of engraving. To reduce the dimensions of the devices in accordance with the law of optics (which states that the resolution of an image is subject to the light wave used), researchers are currently trying to produce powerful sources of light in the spectrum of ultraviolet waves. The research in the field of optics is restricted by the extremely expensive material.

Extraordinarily high integration demands an extremely high investment. In France, one example of this is the technological complex in Crolles near Grenoble. This research center is an international collaboration between Philips, Motorola, and STMicroelectronics.

² The photorepeater exposes a surface on each circuit board and repeats this action for the entire time it is working on it. All other operations of storage or engraving are carried out in exactly the same way across the entire circuit board.

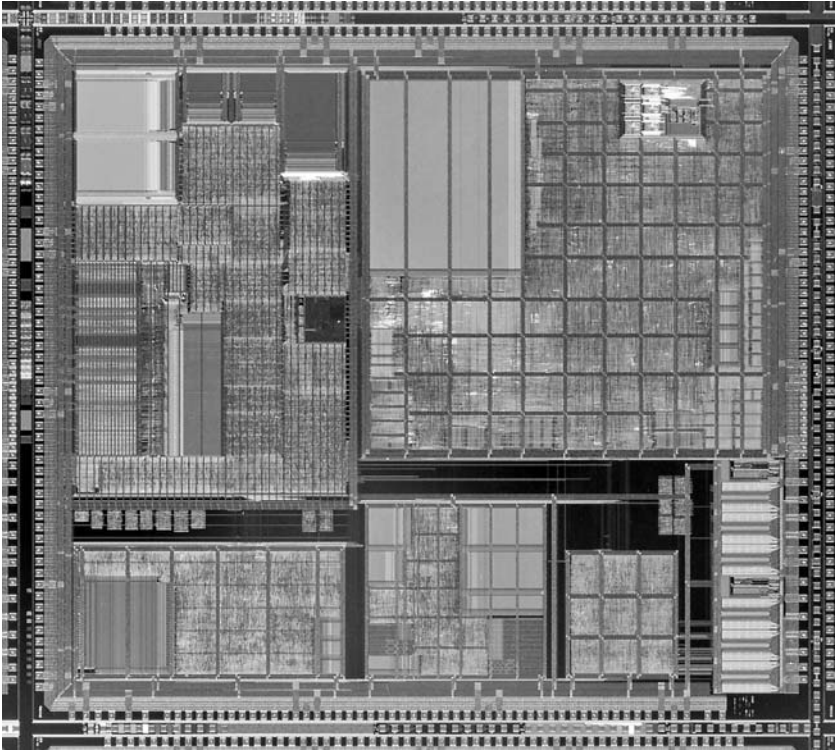

Figure 4.2. *An example of a device for integrated circuits on silicon*



Figure 4.3. View of a 300 mm clean room (STMicroelectronics, Crolles2)

The emblematic circuit in microelectronics, the microprocessor, is made up of one unit that deals with mathematical and logistical tasks needed to process and store given data (computer memories), as well as a control unit that runs the microprocessor as a whole. The control unit transmits commands given by the relevant software.

The production of a microprocessor, or computer-assisted devices, goes through the following steps:

- The new device which is defined in the feature specification is drawn in functional blocks.

- It is then subdivided into smaller components with specified characteristics which are applied according to the information in the relevant database.

- The layout is then documented in an optimized technological plan.

- Using the database, the technological plan is subdivided into different levels corresponding to the operation of photolithography. It is used to produce the “mask”³.

- The production takes place in the laboratory and is controlled at each stage.

- The circuit boards are cut down to the required size and the circuits are tested.

- This process is followed by surface passivation and packaging.

³ Every phase in photolithography corresponds to a mask that defines which parts of the circuit board will be exposed.

4.3.2. *An expanding universe*

Thousands of technological innovations have been applied to the chips that are used today. They are now made up of several million transistors per square millimeter. This is possible thanks to a miracle of nature: silicon and its oxide form a perfect couple⁴ and have enabled the development of the MOSFET transistor. We are part of this triumphant technological era. Intelligence is engraved in silicon.

Reducing the dimensions of transistors, as stated in Moore's Law, leads to a decrease in their energy consumption and the time needed to operate. Therefore, it is possible to increase their data storage as well as the speed at which they process it. This leads to the emergence of ever more complex systems which become smaller and smaller, as well as higher performance communication tools with a greater degree of flexibility. The latest mobile phones combine different functions, such as dictaphone, MP3 player, digital camera, PC games, and payment facilities as well as, of course, the telephone itself.

The last boundary in the realm of physics will be reached only when information can be stored on one single electron. This is unattainable with today's technology, even if in the laboratory objects can be manipulated at the level of a single electron. Other obstacles make the possibility of a computer made up of one single electron a dream rather than a reality. New technology which supports molecular electronics to enable such integration would be required. Nature deals with this in a very efficient, but certainly different, way: our brain!

4 Silicon and its oxide are crystallographically compatible without any weaknesses in the interface which is unique in the domain of semi-conductors.

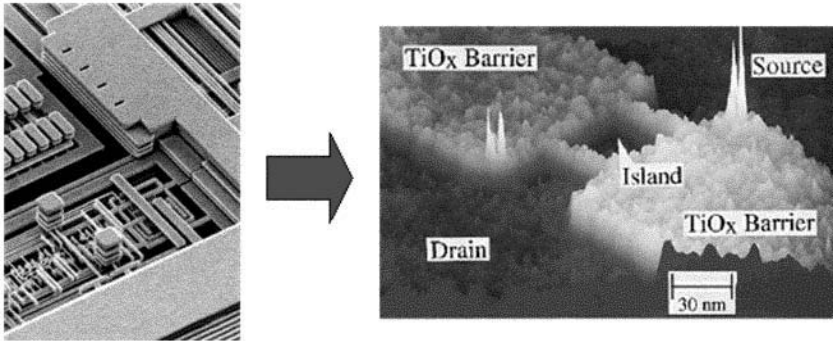

Figure 4.4. *On an atomic scale: the rules of the game are changing. Current integrated circuits are made up of transistors which consist of only one electron. Quantum effects become predominant*

Other components of a quantum nature gave birth to the physics of solids: the group of emitters and receptors of light, such as electroluminescent diodes and lasers. The latter enables the sending of binary information in the form of parcels of photons through fiber optic cables. The information is transmitted at the speed of light. The ultimate development would be to reduce these parcels down to a single photon.

Electronics materialize once again in a large number of new materials, such as flexible LED screens and solar panels which are beginning to be developed from organic polymers. Low-cost fabrication using printing technologies applied to large surfaces (eg printing labels with the help of radio identification), flexibility and the possibility of combining this technology with other devices, makes it very attractive for future uses.



Figure 4.5. Plastic electronics has become a reality. Plastic chips, organic LEDs, clothes, etc.

Electronics have become molecular. The emergence of transistors using carbon nanotubes provides the opportunity to create devices made up of new materials, especially for flat screens. An entire field of fundamental and interdisciplinary research is also currently being developed for organic molecules.

Another form of electronics which is subject to quantum physics and part of nanodevices, is the so-called spin electronics. Spin electronics uses the magnetism associated with the electron, but its usage varies largely. Another interesting phenomenon is the giant magnetoresistive effect. If two magnetic layers are separated by a very thin non-magnetic layer we can observe a strong variation in the electric resistance according to their magnetic disposition (parallel/anti-parallel) which can be influenced by a magnetic field. Every actuator arm traveling over the top of a hard disk uses this property (magnetoresistive tunnel). Other effects are also exploited and new products of ever increasing performance are always being created. The first data storage chip MRAM (magnetic random access memory) of 4 Mbit produced by Freescale was voted “Product of the Year” by the *Electronics Products Magazine* in January 2007. The integration of this new generation of reprogrammable data storage and the CMOS (complementary metal oxide semi-conductor) technology will revolutionize the concept of microprocessors in the future.

This convergence of electronics and the magnetism of the electron have paved the way for a new form of science: spintronics. Some companies consider this to be the future of electronics. IBM and Stanford University announced the creation of a new research center entirely dedicated to this field.

Effects that were once only discussed in print are now used and are already being applied to devices in laboratories. One of these is the phenomenon of teleportation made possible by cryptography. The idea consists of instantaneously moving an object or an individual from A to B without the usage of traditional means of transport. The experiments were carried out using

photons. It is difficult to imagine what type of results could emerge from this if they could be mathematically interpreted in the field of quantum physics.

4.4. Programs

Circuits are built to carry out a certain number of operations which, put together as a whole, enable the creation of programs. This is a result of orders that were previously stored in the computer memory and are now executed in the frequency determined by the timer. All information finally comes down to the binary code and every instruction can be brought down to basic operations which are controlled by the central unit.

The analogy of the brain allows us to consider two different types of programs: one of these programs corresponds to the basic innate functions and the other to acquired knowledge. The basic functions are already present in a computer; it needs to understand and correctly apply the “knowledge” it has acquired, ie all those programs installed at a later date.

Man-made programs give machines a form of “intelligence”. In return, we have access to memory of an almost unlimited size (the gigabyte⁵ is becoming commonplace) and rapid information processing. Signals from the control unit enable the program to identify the data by its address and transmit it to the data processing units. Furthermore, the results are saved for future reference. The clocked circuit directs the large number of parcels of electrons whose operations run very smoothly within the microprocessor.

We can therefore observe a harmony between quantized structures from our world and quantifiable information.

⁵ The byte corresponds to eight binary numbers.

4.5. Some bonus material for mathematicians

The smallest amounts of information within any computer are represented by 0 and 1; they are called bits (BINARY digiT). In information technology every problem can be solved by a stream of operations expressed in a clearly defined language: the algorithm. In a calculation, all functions can be brought down to basic and logical functions made up of NO, AND, OR. In electronics, this corresponds to simple circuits.

The byte (8 bits) allows 256 different combinations of 0 and 1. It is used to encode numbers and letters of the alphabet, as well as a certain number of symbols (eg American Standard Code for Information Interchange (ASCII)). In this way, a sentence corresponds to a group of words and a word to a group of letters. Eventually, they can all be transcribed into binary code.

Let us take a basic operation to illustrate the calculating process of binary additions. This addition is carried out in the microprocessor's arithmetic and logical unit (ALU). The binary adding scheme works as follows:

$$0+0=0$$

$$0+1=1$$

$$1+0=1$$

$$1+1=10$$

In order to create an adder, we often use a sequence of logic gates called AND. The following logic applies to its operations:

0 and 0 equals 0

0 and 1 equals 0

1 and 0 equals 0

1 and 1 equals 1

In microelectronics, a logic gate is built with the help of some transistors that are linked to each other. Nine logic gates are required for the addition of two bits.

The binary code is perfectly adapted to highly integrated technology because it enables us to replace all calculations, no matter how complex they may be, by a sequence of basic operations which can be carried out rapidly.

Based on mathematics, the “Boolean”⁶ logic provoked a technical revolution, especially in the field of information technology, as it enables us to create programs. This has led on to the creation of artificial intelligence computers.

The MOS transistor and the fantastic adventure of electronics

The MOS (metal oxide semi-conductor) transistor perfectly fulfils two different functions. On one hand, it works binary “on/off”, and, on the other hand, “planar” technology is applied. In the case of “planar” technology, the electrical charge travels from the source to the drain passing through a channel (currently its length is about 100 nanometers) which is oxidized at the surface. The control unit of this channel is an electric field induced by a potential applied on the grid (the M of MOS refers to the metal wire grid which has now been replaced by silicon, but the first letter of the acronym remains the same). It is situated on top of the oxide and works as if a hose was being compressed in order to stop water flow.

The chips we use today consist of transistors which form complex circuits. Currently there are 50 million of them in a microprocessor. Their production runs through different phases and needs special conditions. They need basic storage functions, to be engraved, and to undergo thermal treatment which alternates with photolithography. In the laboratory, the wafers, which have a diameter of 30 centimeters, are processed in a clean environment. In order to treat the surface of a circuit board selectively, we cover it with photosensitive resin and a mask in order to expose only certain areas. Chemical treatment will then remove either the exposed or the unexposed area to prepare the surface for engraving. This is where the

⁶ Operations on logical variables.

situation becomes critical because the resolution depends of the wavelength and the light used.

There are several possible solutions for reducing the size of transistors:

– The use of a light source at the shortest possible wavelength in the spectrum of ultraviolet which is compatible with optical transmission systems (lenses). Currently, the best performing light source sends waves, including its own length, of between 20 and 100 nanometers. This will enable the production of a future generation of lithographic semi-conductors of 32 nanometers (mass production is planned for 2013). Within the limits of today's knowledge, this is the best solution for the production of computer chips.

– The use of the electron beam of a scanning electron microscope (SEM) to draw a circuit on the resin. This solution enables the smallest possible dimensions of the circuit to be used, but is not adaptable to mass production. This form remains limited to research and special circuits.

– The use of an X-ray. This source exists, however, in its general form, or as synchrotron light; its usage remains unusual. On one hand, this radiation comes from enormous machines and on the other hand, we cannot use any optics other than reflective optics (mirrors and adapted crystals). This type of source is still only used in research laboratories, but it is likely to be the technology of the future.

– Free oneself from the laws of the classic propagative optics which limit the resolution to the wavelength by using “evanescent waves”⁷. This is a fundamental field of research.

7 Evanescent waves are a solution from the Maxwell equations when dealing with an interface, whether it is flat or not. These interfaces are part of solutions for the near-field whose application we find in a large number of related technologies, such as near-field scanning optical microscopes.

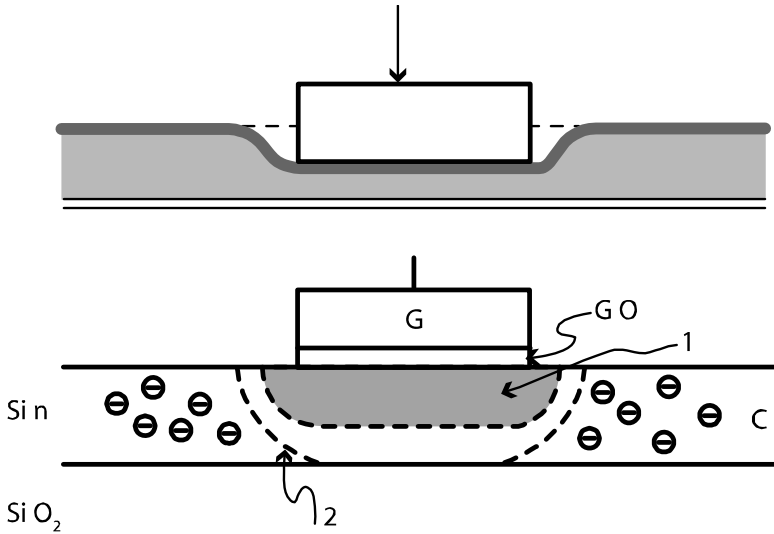

Figure 4.6. *The MOS transistor*

This is a field effect transistor. Its hydraulic analogy is represented in the form of a tube whose output can be adjusted by compression.

Its miniaturization largely depends on the size of the wired grid. This wired grid controls the passing of electric charge through the channel by an induced, generally negative, potential (open/closed or on/off). Its relatively simple fabrication and its perfectly adapted geometrics make MOS one of the universal components in computer storage.

Si n: type n silicon, SiO₂: silicon oxide

G: metal wired grid, C: channel, GO: oxide of the wired grid

1- deserted zone (open channel due to a negatively charge wired grid $V < V_c$)

2- blocked channel ($V = V_c$)

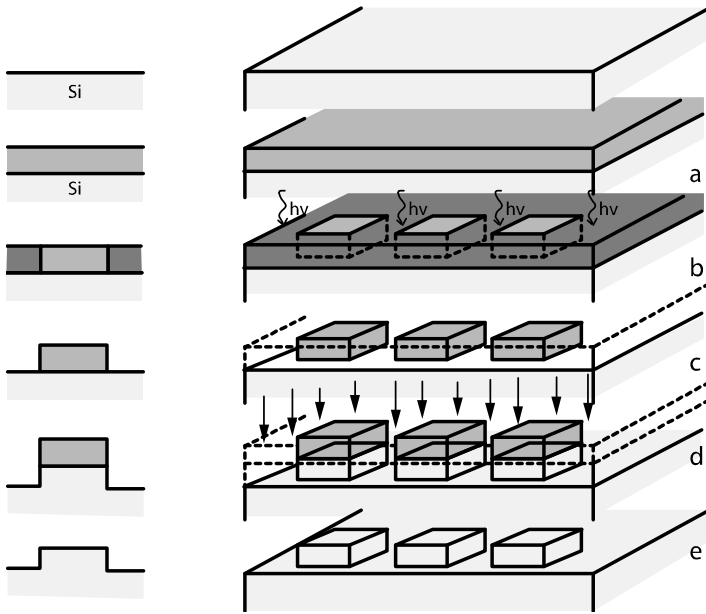

Figure 4.7. *Photolithography*

Stages in the fabrication of circuit boards (Si): a) photosensitive resin is applied; b) optical protection with help of the mask and exposure of the resin; c) removal of the now activated resin; d) selective engraving of the unprotected silicon by shooting ions on its surface; e) removal of the remaining resin and creation of silicon dots.

This page intentionally left blank

Chapter 5

Mechanics of the Living World
Convergence on the Molecular Level
Bottom-up Example

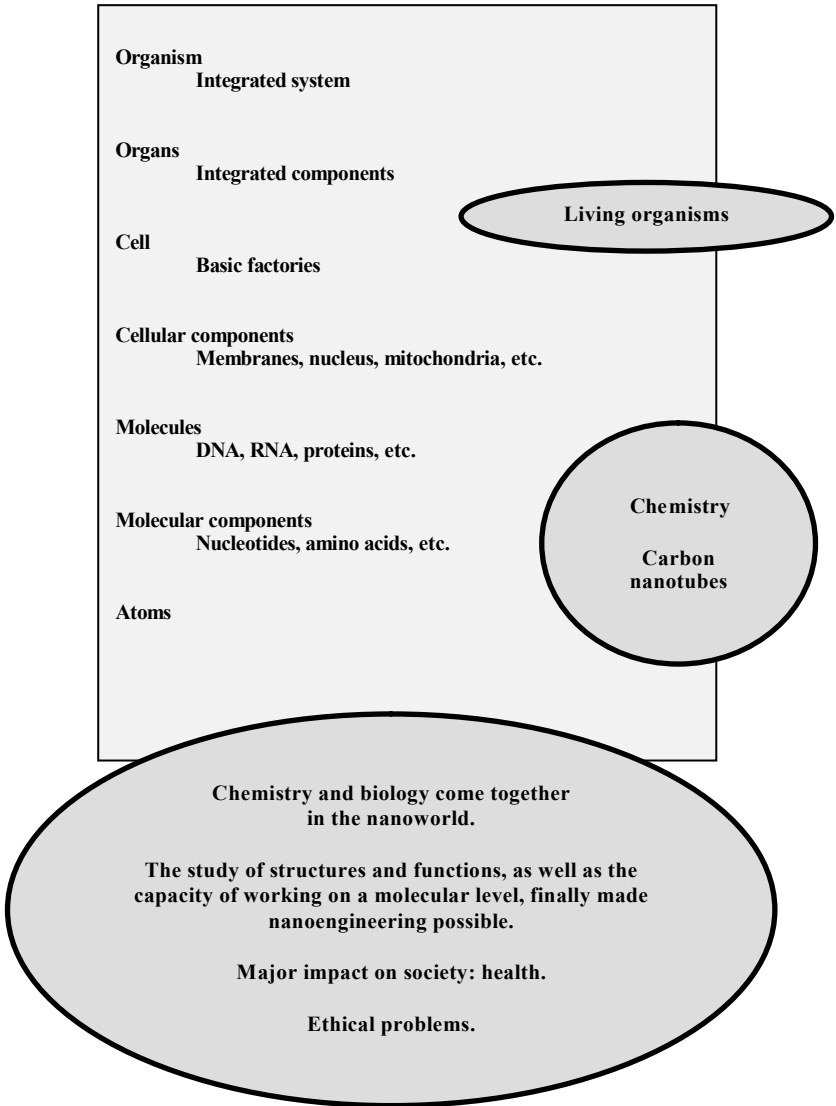

The evolution of living organisms is a result of random characteristics chosen according to needs.

(Jacques Monod¹)

The field of electronics is a very organized one. It is based on many identical components which are interconnected. Quality is the highest priority in their production. This implies considerable logistics. Its logic is all or nothing, yes or no, on-off.

The world of living organisms, however, follows a very different logic. It is made up of molecules with functional properties allowing the creation of organisms that reproduce.

This logic is based on self-organization and the emergence of assemblies that possess new properties and performances. All this makes natural systems complex. It encompasses a succession of innovations which have taken place over more than a billion years in order to become the organisms that they are in today's world. Each of the organisms has a universal basis: the self-replication of certain molecules which are centered around the smallest common denominator of life, the cell.

¹ Nobel Prize for Medicine in 1965.

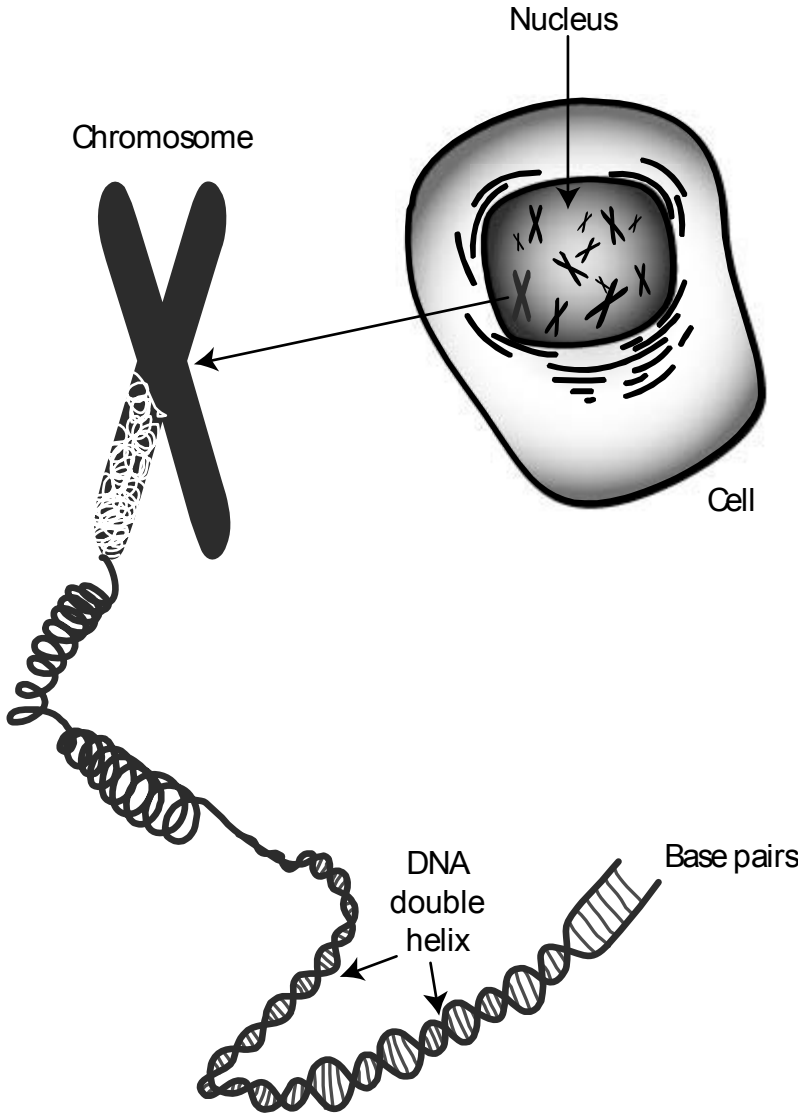

Figure 5.1. *The cell, chromosomes and DNA.
An organization based on a billion years of evolution*



5.1. Proteins – molecules with exceptional properties

AAGCCTAATCCGTATTCGAAAT ... or the genetic code of life. Biology shows us how the world of living organisms works.

DNA (deoxyribonucleic acid), RNA (ribonucleic acid) and ribosome make up a nanoworld consisting of nanocomputers, nanosystems, and nanomachines of unbelievable complexity. It should be remembered that nature took around four billion years to create what can be observed today.

Apart from the very beginning, which is still being discussed (molecules came from space or appeared in the mix of the first ocean), the world of living organisms followed an evolution based on a process of natural selection involving certain mutations. This is how our planet's current species developed².

This process is, of course, also subject to the laws of physics. For reasons of energy (photosynthesis)³ and organization (entropy)⁴, this process was only possible due to rays of the sun.

2 Charles Darwin's *The Origin of Species* (published in 1859) explains the theory that different species evolved over the course of generations due to a process of natural selection. The English naturalist was unaware of genetic mutations which are the basis of evolution.

3 Plants, which are on a lower biomolecular level than humans, use rays of the sun to carry out photosynthesis, a process that produces elements that humans need for the makeup of their own body (eg proteins).

4 Evolution led to the emergence of self-organized systems. The increase in complex systems corresponds to a decrease of entropy. This is a thermodynamic reaction to disorder which conforms to the second principle of thermodynamics for an open system that receives rays from a source with a high temperature.

The basic component of all living organisms is the cell. Some organisms are made of just one cell (eg bacteria), some out of around ten, and others out of several billion including different types of cells. Human beings are made up of 10^{13} to 10^{14} cells. One of the main features is the cell's unique functioning which varies according to the type of cell. The main variation between different kinds of cells is whether they have a nucleus or not. This distinguishes prokaryote and eukaryote organisms. The main functions of a cell consist of a "program" which possesses all information needed to develop the relevant organism, as well as a system which "reads" these instructions, and a device which "produces" the elements required for the development of the cell.

5.1.1. *The program of cellular production*⁵

This program can be found in chromosomes. These are long molecules consisting of DNA. In 1953, their structure, the double helix, was discovered by the British physicist Francis Crick and the American biologist James Watson (for their discovery they received the Nobel Prize for Medicine in 1962). Every helix consists of a long line of four different types of molecules, the so-called nitrogenous bases, Adenine, Guanine, Thymine, and Cytosine, also often referred to as A, G, T, C. These nitrogenous bases encode genetic information on the basis of phosphates and sugar linked together by a strong covalent bond⁶. Each component links with another specific base: A links with T, and G with C. These bases are linked to each other via weak hydrogen bonds. A gene is a sequence of DNA which encodes a specific function (eg fabrication of a protein). The entire set of genes (30,000 for human beings) defines all characteristics of the relevant organism.

5 The physicist Erwin Schrödinger had the idea that the instructions needed to develop an organism were saved on some kind of "non-periodic crystal".

6 This chemical bond corresponds to the sharing of electrons, which forms a molecular orbital.

Using a book as an example might be helpful to create a mental image of DNA. The text is written in an alphabet that consists of four letters. This book is a very important heritage and needs to be protected. As in a library, where a fragile and precious incunabulum cannot be used directly, a photocopy of every chapter is made. The same process applies to the replication of DNA (genes). The transcription will take place after the unwinding and opening of the DNA double helix (eg a zipper) thus forming the messenger ribonucleic acid (mRNA).

Messenger ribonucleic acid encodes and carries information from DNA during transcription to sites of protein synthesis to undergo translation in order to yield a gene product.

All operations (replication, transcription and selection of the required sequences) are carried out by specialized molecules that recognize the code and carry out the appropriate steps.

In the case of eukaryotes, the mRNA leaves the cell nucleus and moves into the cytoplasm where protein synthesis takes place.

5.1.2. Reading instructions and the production of proteins

The assembling of amino acids, elementary components of a protein⁷, takes place in a unit called a ribosome. Proteins and ribonucleic acid (RNA) read the information delivered by the messenger ribonucleic acid (mRNA). Every codon (triplet of nucleotides in a nucleic acid sequence) is used as a code to specify

⁷ Amino acids are mainly absorbed through our food. Our body is, however, able to produce its own amino acids in its “chemical laboratories”, which are, for example, located in the liver. The rest, the so-called essential amino acids, need to be absorbed through our food (eg proteins).

a single amino acid⁸. The fabrication of a protein can be compared to making a pearl necklace. The transcription stops after a so-called stop codon and the protein moves into the cell.

A huge variety of proteins exists. They ensure very diverse functions of the organism: structural, catalytic and signal transduction. In the complex system of cells, their transport is either carried out by random movements (Brownian motion) or by transporting devices assisted by molecular motors.

Each characteristic of every person can be found in every single one of their cells. However, in the process which starts with the zygote and carries on to a fully grown organism, all cells develop their specializations. With the help of *ad hoc* proteins, very complex mechanisms, most of them still unexplained, irreversibly repress the development of characteristics carried by certain genes. The zygote is totipotent. It not only allows the development of an entire individual, but it is also the origin of all other cells in that individual. Other cells are able to adapt themselves; they are called omnipotent. Another form of cells only reproduces specialized cells. This brilliant process is highly reliable due to multiple control and repairing systems.

⁸ Strictly speaking, the relation between codons and amino acids would lead us to the following calculation: $4 \times 4 \times 4 = 64$. In reality, there are, however, only around 20 amino acids. All other possible codons do not relate to an amino acid and several different codons are used to encode the same amino acid.

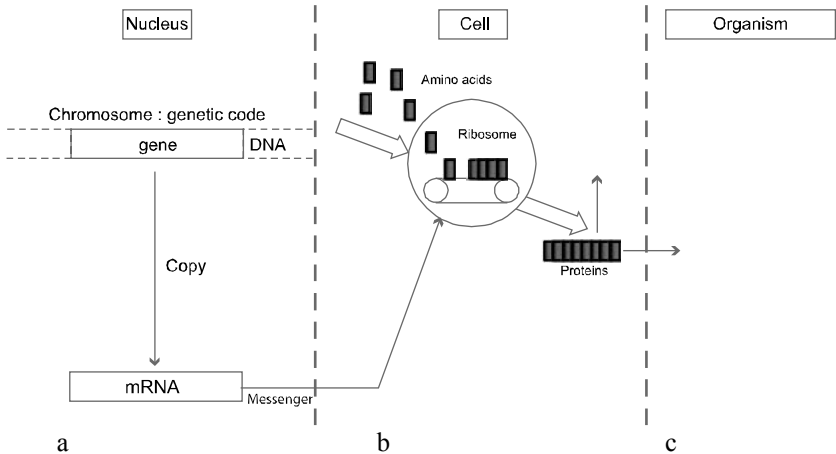

Figure 5.2. *The path of complexity*

Billions of living organisms stem from an alphabet that consists of four letters.

a) The nucleus is the guardian of the program. Everything is encoded by four nitrogenous bases (A,G,C,T for the DNA and A,G,C,U for the RNA).

b) In the ribosome, proteins are produced by the merging of amino acids. Messenger ribonucleic acid (mRNA) provides the information encoded in the form of codons, each codon corresponding to one amino acid. There are around 20 amino acids. Thousands of different proteins are made up of them. The proteins are used inside and outside the cell (arrows).

c) These proteins contribute to the development of hundreds of thousands of different species and billions of living organisms.

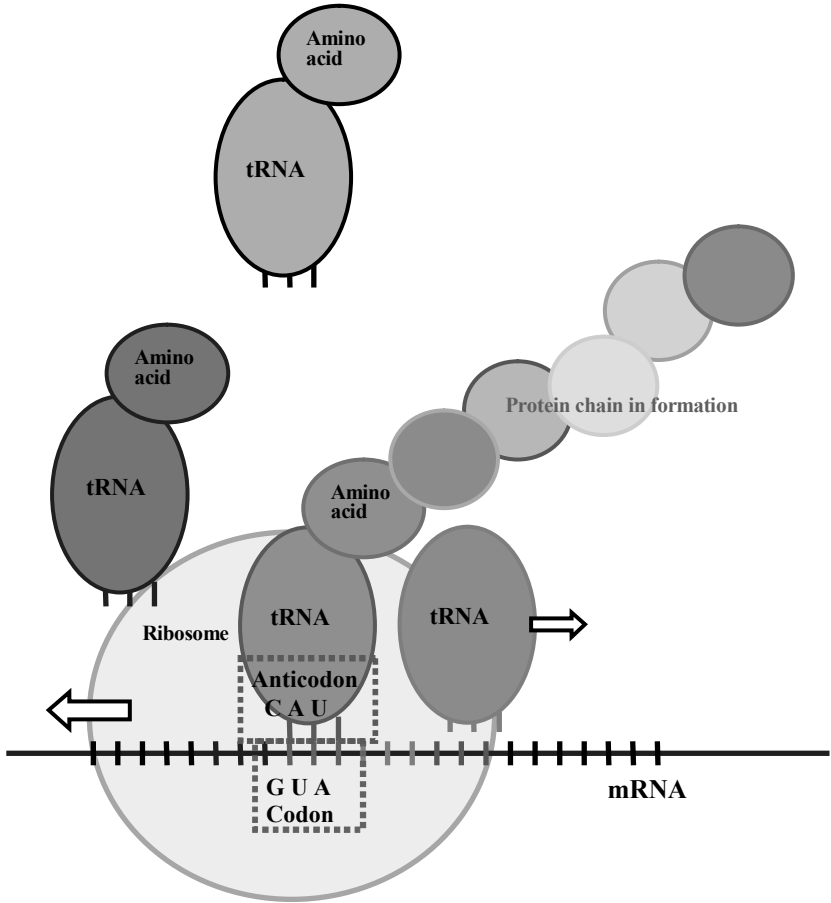

Figure 5.3. *The creation of a protein in ribosome*

Transfer RNA (tRNA) moves all amino acids to a growing polypeptide chain in the ribosome. tRNA is a short RNA chain; amino acid links to it on one side and a three-base region called the anticodon that recognizes the corresponding three-base codon region on mRNA via complementary base pairing (eg CAU corresponds to GUA). After tRNA and mRNA form a bond, the amino acid will disconnect itself and link to other previously translated amino acids. The tRNA breaks off its bond as soon as another tRNA carrying the next amino acid forms a connection with the ribosome.

5.1.3. *How does it work?*

No matter how complicated the mechanism might be, it is always linked to the molecular pattern. The structure of a molecule determines its function. The image of a key fitting into a lock is therefore often used⁹. The structure of one molecule corresponds to the structure of another one. These two will therefore form a bond leading to a specific result (passing through a membrane via a specific “gate”, catalytic reactions, etc.). We should be aware of the fact that within the range of temperatures that living organisms require for survival, everything constantly vibrates. The different molecules are perpetually agitated in their liquid environment. If the temperature is too low, reactions slow down and can stop. If the temperature is too high, molecules can be destroyed.

For mammals, the system is so delicate that their body temperature is fixed; for human beings¹⁰ this temperature is 37°C. Everyone is aware that a few degrees of difference in body temperature can have a profound effect.

The diversity of molecules enables the existence of molecular communication systems (hormones). It should not be forgotten that this is all based on four billion years of trial and error.

9 However, the idea of molecules and rigid interactions cannot be used on all occasions. The lock and key theory is widely accepted but is not always a perfect solution. This concept does not allow for diversity and adaptability. It is essential for the survival of all species that there is a certain degree of flexibility enabling the ligand to adapt better to its receptor. Evolution does the rest. Too much diversity and adaptability would have a reverse effect on efficient functioning.

10 Just like light (photons), vibrations also have their corpuscular nature on the quantum level (phonons). All components vibrate if the general level of energy is at 26 meV (millielectronvolts) at that temperature. The amount of energy of covalent bonds is of several electronvolts, or even less for hydrogen bonds. Other biochemical reactions correspond to an extremely selective and “soft” catalysis. There would be no life if molecules were unable to link to each other and form loose bonds.

5.1.4. *Molecular disfunctioning*

5.1.4.1. *External causes*

– Unicellular microbes or bacteria: they disturb cells by using their functions for their own benefit; this may even result in destroying cells. As far as human beings are concerned (this varies for other species), our body possesses a powerful molecular control system that differentiates between our own (self) and foreign (non-self) molecules. Our immune system protects us. Specific molecules, so-called antibodies, detect molecules that are not part of our body (so-called antigens) and with the help of soluble mediators and immune cells, participate in their destruction. Preventive vaccinations may prepare our organism to better resist infections. But the organism's natural defenses have their limits and need to be supported by medication such as antibiotics. Antibiotics are the most efficient group of medication against infection. Note that humans live in a symbiosis with many bacteria. The body tolerates them and they are essential to our metabolism.

– Viruses: incapable of surviving on their own, they penetrate cells and multiply within them. Viruses are a kind of “program” that manipulates the vital mechanisms of the host cell. They can slip past the immune system or destroy it (eg HIV in AIDS). These parasitic programs have their equivalent in information technology, ie computer viruses.

5.1.4.2. *Internal causes*

– Genetic disorders: conditions caused by the abnormal expression of one or more genes in the zygote. For example: trisomy 21, cystic fibrosis, hemophilia.

– Cancer: in the entire transcription process, from decoding to the fabrication of proteins, the delicate cellular mechanisms can be disturbed by various causes. In spite of the presence of control and

repairing systems in the form of specific molecules, the damage can be too extensive. The last resort, the programmed destruction of that cell, which is called apoptosis, will happen in that case. If this order is not carried out, the cell becomes out of control and a cancer may develop. Cancer depends very much on genetic predisposition and is mainly induced by external causes such as ionizing radiation, carcinogen substances, viruses, etc. In fact, its causes and development vary enormously, which is the reason for the complex and diverse forms of treatment.

– Autoimmune diseases: for example, diabetes mellitus type 1, multiple sclerosis, rheumatoid arthritis, systemic lupus erythematosus, etc. In the case of each of these diseases, the immune system is deregulated and cannot distinguish its own elements from exogenous elements. It therefore fights its own organism.

5.2. Intervention of human beings

Medicine is a science which gives medication that it does not know very well to an organism it knows even less.

(Voltaire¹¹)

Since Voltaire, great advances have been made in the fields of biology and medicine, especially for those diseases with a previously high mortality rate which had been completely eradicated or were under control due to vaccinations¹² and antibiotics¹³. The recent understanding of the mechanisms and

11 Voltaire: French writer and philosopher of the 18th century.

12 A famous example is the vaccination against rabies which was created by Louis Pasteur (1822–95), a pioneer in microbiology.

13 In 1928, Sir Alexander Fleming discovered penicillin. In 1945, he received the Nobel Prize for Physiology and Medicine for this discovery.

codes used by living organisms is no doubt a major discovery in the field of health.

Human beings are now able to intervene on a molecular level in these mechanisms. Biological engineering is developing. From cloning to genetically modified forms of treatment, every day brings about a new discovery or some sort of *première* in the field of experimental innovations. Genes can now be cut, transplanted and introduced into different environments. The operations are similar to those of a virus which manipulates the functions of a cell. We might use these technical advances and the miracles of nature to our own advantage.

Active research is currently being undertaken in the field of health care.

5.2.1. Medication

Two complementary approaches are used. Computer-aided design (CAD) is applied to molecules to develop the desired functions. This includes the screening of billions of molecules thanks to the modern techniques of robotization and miniaturization (eg biochips). New opportunities are always arising for the treatment of cancer and genetic disorders, such as cystic fibrosis.

5.2.2. The creation of those famous GMOs (Genetically Modified Organisms)

On an industrial level, this technique is currently only applied to vegetable organisms and certain types of yeast.

It seems obvious that in the future this type of manipulation will replace breeding and the know-how already exists. The genome of

several species has already been decoded. Once the functions of all genes have been fully discovered it will be possible to manipulate them and use this cellular machinery for our benefit.

From a scientific point of view it could be suggested that mankind is taking on the role of Mother Nature. The resistance of bacteria towards antibiotics is due to the transmission of resistant genes from one bacteria to another. Natural selection then completes the process. Natural selection is one of nature's main forces, as a colony of bacteria usually consists of several billion organisms.

5.2.3. *Manipulation of embryos*

In France this is illegal¹⁴.

Scientists know how to manipulate germ cells, remove a nucleus from one cell and transfer it to another cell. In the future, scientists might be able to intervene on the level of a single gene.

Molecular biology therefore opens a door to a new world, which includes, however, a certain number of risks to which we will come back later.

5.3. Some bonus material for biologists

Nanoobjects in biomedicine – carbon nanotubes.

Carbon nanotubes correspond to a new form of carbon wrapped in layers of graphite. They were discovered in 1991 and immediately appeared as potentially interesting products because

¹⁴ The Agence de biomédecine (French agency for biomedicine) is responsible for integrating research into a legal and ethical framework.

of their electronic, mechanical, thermal, and chemical properties. Further explanation of these will be given in the next chapter. Carbon nanotubes were also found to be of great importance in the fields of nanobiotechnology and biomedicine.

The field of biomedicine has recently developed a strong interest in carbon nanotubes as they can form supramolecular structures with proteins, peptides, polysaccharides, nucleic acid, and lipids. The usage of carbon nanotubes in biology made no headway for a very long time because of their complete insolubility in all different kinds of solvents.

Different methods designed to solubilize carbon nanotubes were recently developed. One approach to make them soluble is based on the grafting of solubilizing groups to carboxylic functions which appear during the nanotubes' oxidation process.

Another method used for obtaining carbon nanotubes that entirely dissolve in organic and aqueous solvents consists of modifying their outer walls by organic functionalization. This type of solubilization makes them easier to manipulate and to introduce into different materials; it also led to the first biological applications of carbon nanotubes possible. A research group from Strasbourg first franchized this unique method which made functionalized carbon nanotubes soluble in physiological medium, as well as in water. On the surface of these nanotubes, various types of molecules such as antigenic peptides have been linked. Furthermore, it was shown that the peptide nanotube conjugates were able to provoke an efficient response from the immune system. With fluorescence microscopy, research showed that functionalized nanotubes are indeed able to penetrate cells.

These results make way for multiple applications in the field of "vectorization", or transport of molecules used for therapy and vaccination.

Electronics and the world of living organisms create an artificial ear!

Scientific literature shows photographs of neurons linked to a lattice of transistors. Apart from these rather vague experiments, we are still far from placing neurons on a circuit board and we are even further from creating mixed circuits made of electronic and biological devices. On the other hand, the progress made in the field of direct electrical stimulation of neurons enables us to produce implants that carry microdevices. These work as communication agents with neurons.

A very good example of the usage of new technologies is the cochlear implant. This is a surgically implanted electronic device¹⁵ that can help to provide the sense of sound to a person who is profoundly deaf or severely hard of hearing as it replaces the missing or damaged receptor.

This device has gone into industrial production and can be implanted at specialized centers. It includes two components: one electronic device, which is implanted into the bone beneath the skin, and a speech processor.

- Sound is picked up by a microphone and transformed into electric signals by the vocal processor. According to a special code, the vocal processor transforms them into electrical impulses.

- These impulses are transmitted through the skin via electromagnetic waves and picked up by the implanted receptor.

- The receptor produces a series of electric impulses which, via an electrode fiber, directly stimulate the neurons without using the damaged cells.

- Once stimulated, the cochlear nerve (also auditory nerve) sends electric impulses to zones of the brain which then interpret them as sound.

15 Centre d'information sur la surdité et l'implant cochléaire (CISIC), French information center on deafness and cochlear implants: <http://www.implant-cochleaire.com>.

The entire process, from the sound being picked up by the microphone to the processing of it by the brain, is instantaneous. The patient therefore perfectly understands utterances once the process of auditive rehabilitation and speech therapy is completed.

Even if its realization is much more complex, will it one day be possible to create an artificial eye? Will the world of silicon and the world of living organisms finally be able to see each other?

Chapter 6

The Uses of Nanotechnologies

They are Everywhere!

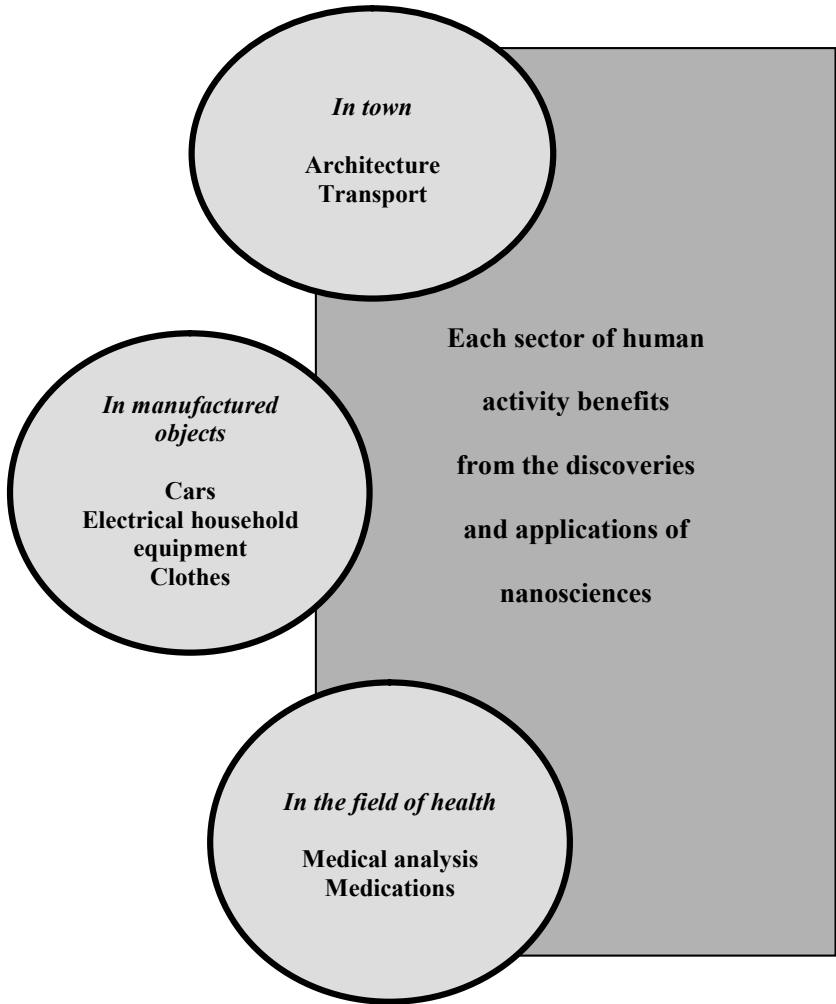

6.1. New objects

Given their size, nanoobjects have specific qualities which prove useful in a number of different applications. Structures with new properties possessing the properties similar to those of both a molecule and a solid are being discovered. In order to illustrate this, the beginning of this chapter will deal with two nano jewels.

6.1.1. *Carbon in all its states*

The carbon atom, with an atomic mass of 12 and with six protons and six neutrons, is the sixth heaviest element. Its isotope C^{14} is unstable and transforms into nitrogen over a period of 5,730 years. It is a well-known biological tracer which is used as a dating element.

Its exceptional properties, which are due to its four bonding electrons, explain the importance of its role in the natural world. It exists in all molecules; molecules being the building blocks of flora and fauna. The vast majority of these molecules are unreachable by chemical synthesis. For the moment, we can only admire and use these natural products that have developed throughout the process of evolution.

Carbon also exists as a solid, in particular as a diamond, which is the symbol of perfection. Humankind has been able to use the symmetric properties of these incredibly hard gemstones which are formed under conditions of extreme temperature and pressure beneath the earth's surface.

Carbon is also present in the form of graphite, which is found in large quantities in certain types of sediment. This graphite is also made from coal, which is made up of graphenes that are piled up on top of one another, like the pages of a book, with weak bonds existing between each layer.

Two different types of nanoobjects exist which are made up of carbon.

6.1.1.1. *Nanodiamonds*

Produced by plasma spraying techniques¹, nanodiamonds are made of thousands of atoms and their enhanced hardness is used to create specific coatings. After the nanodiamonds are treated with luminescent properties, they are used as a single photon source for the study of quantum cryptography. Coated with active molecules from the natural world, these nanocrystals will make excellent biological markers for analysis in the field of confocal microscopy.

6.1.1.2. *Carbon nanotubes*

Carbon nanotubes are the most well known of the nanostructures. Originally, the electric-arc vaporization of carbon atoms, or the laser radiation of atoms, produced some strange structures. The most well known is fullerene C⁶⁰, made of 60 carbon atoms whose structure resembles that of a soccer ball².

The conditions required in order to obtain closed and roll structures were met very quickly. These single or multiwalled rolls in the form of tubes with a diameter of a few nanometers, as well as the remarkable physical and chemical characteristics of the atomic grids, enable scientists to use them in numerous fields of scientific study.

Their mechanical qualities (ten times harder than iron) enhance the resistance of textiles and composite plastic materials when they are inserted as adjuvants, just like an iron framework in concrete.

1 Method of depositing ionized atoms in high-frequency heating ovens.

2 Fullerenes were discovered by the chemists H. Kroto, R. Curl and R. Smalley. This discovery earned them the Nobel Prize for Chemistry in 1996.

Their electrical qualities (as insulators, semi-conductors or, in certain cases, conductors) make these structures particularly attractive for the creation of electronic components at a level of miniaturization that has so far never been achieved by silicon technology. As a result, the smallest transistor in the world was made on a nanometric level.

However, significant difficulties remain with regard to the creation of complex circuits. As far as these difficulties are concerned, nanotubes do not really provide any reliable solution. Furthermore, the reproducibility of the electrical characteristics is not perfect. Nevertheless, top-down silicon technology still has a lot to offer before this new technology is completely understood.

The use of nanotubes in the area of biosensors seems more likely. Chemists know how to transplant specific molecules to the biosensors which are able to bond with other molecules in a particular environment so that they can be analyzed. Consequently, high-quality detectors are created. These machines are used for the transportation of medicine inside the human body as seen in the section entitled “Some bonus material for biologists” in the previous chapter.

Nanotubes are rather odd objects. Even if for the moment we are unable to produce nanotubes with homogenous electrical characteristics, we are, however, able to prepare a nanotube deposit on a substrate surface which is semi-conducting³. We can make low-cost solar cells and circuits which can be used for transparent electrodes, flat screens with electroluminescent diodes and, once correctly adjusted, biocompatible substrates.

³ This phenomenon occurs due to the mathematical properties of a network of finite-size tubes that have variable statistical combinations.

We can also make them grow. A new generation of large, flat screen televisions made at LETI (Laboratory for electronics and information technology of the CEA, which is the French national establishment for nuclear matters), and by large companies such as Samsung, is very promising. The starting point of this technology is identical to that of plasma screens which are made up of a matrix of micro electro guns (corresponding to pixels)⁴. The micro-emitter of electrons with molybdenum ends is replaced with a microcarpet of nanotubes which are grown on catalyst plots. These catalyst plots are inserted during the production process of the device which results in a reliable product at a competitive cost.

This is a field of major and interdisciplinary research and innovation.

⁴ This device is known as a cold cathode as opposed to traditional thermoionic electron guns where the electrons are emitted from a heated filament. We use the effect of a strong electrical field created around a specific polarized point which removes the electrons. This phenomenon is used, for example, to remove electrostatic charges from airplanes by using points of conduction at the end of the wings. The nanometric dimensions used here allow for weak biasing of up to 10 volts.

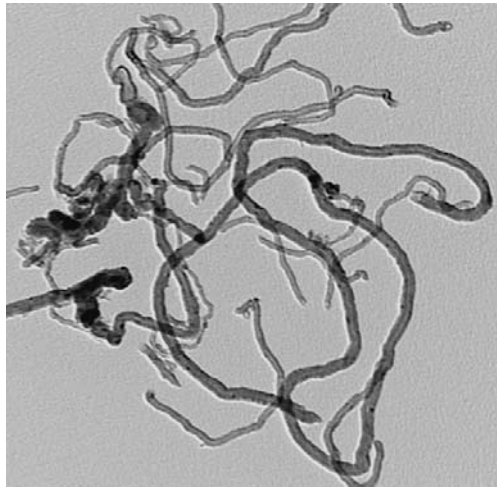
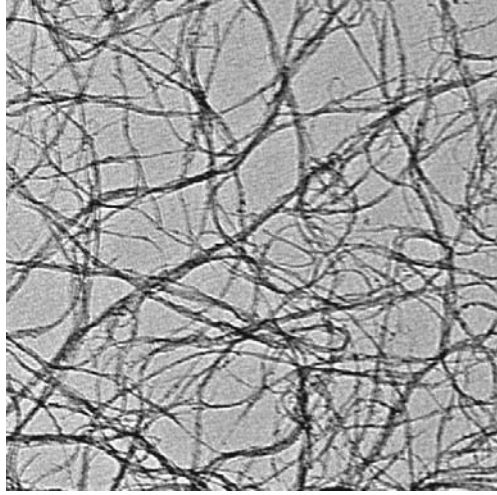

Figure 6.1. *Carbon nanotubes*

This image shows nanotubes with a single inner wall (up) and nanotubes with multiple inner walls (bottom), as observed using a transmission electron microscope.

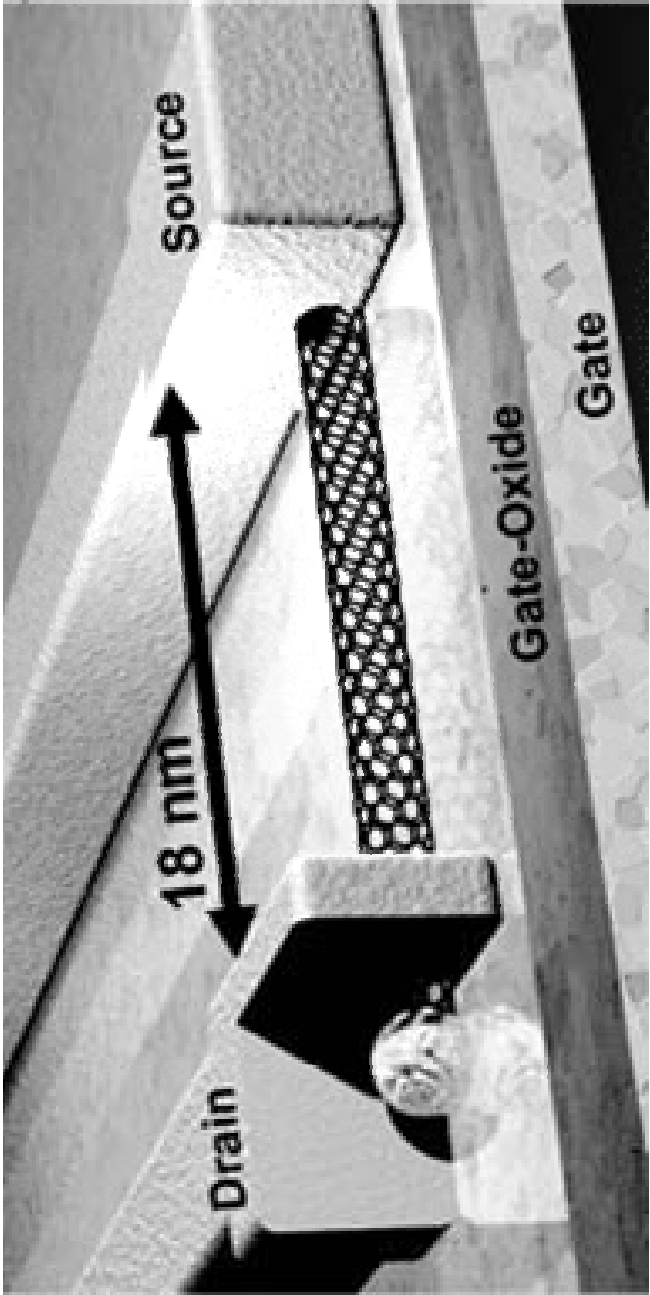

Figure 6.2. *An artist's view of the smallest nanotube transistor in the world*

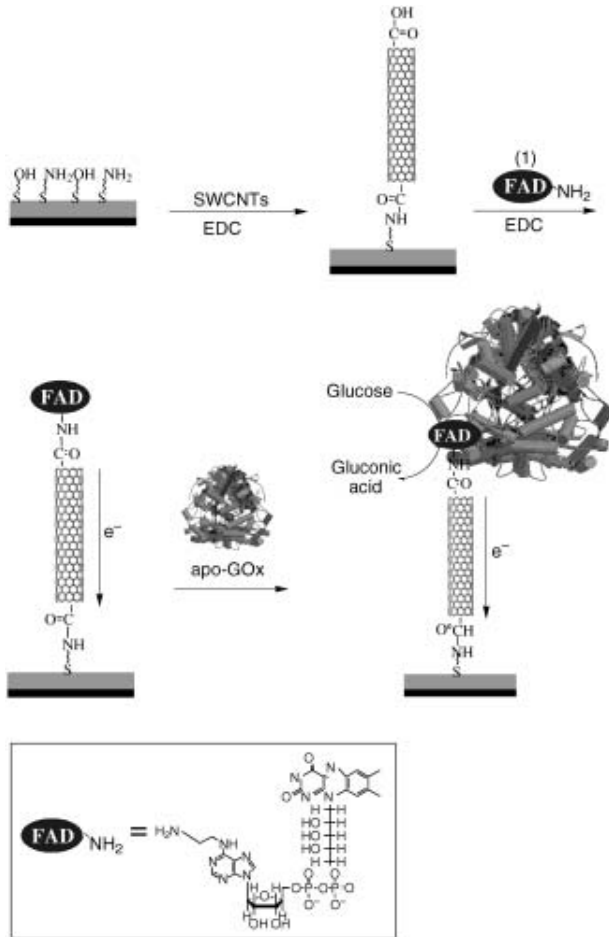

Figure 6.3. How carbon nanotubes work and the configuration of biosensors on a bed of coir-fibers

The bed of coir-fibers is made up of a layer of nanotubes which are arranged perpendicularly to the surface. Such a layout enables scientists to make the most of the shape of the nanotube to amplify the surface concentration of the entities to be stabilized. The figure shows the example of using a carbon nanotube in order to detect an apo-GOx enzyme. The detection can either be electric or optic.

6.1.2. *A handful of gold atoms*

Gold as a metal is a well-known material. Its inalterability and its malleability have made gold the metal that has been used since ancient times for the creation of various objects of art. Gold has been used for centuries by painters and glassblowers due to the optical properties of this metal. During ancient times, people were able to create gold objects, but were unable to explain the physics behind it. Scientists now know that the luminescence of the gold particles depends on their surface-volume ratio. Understanding the process behind the luminescence of gold particles enables the preparation of nanoballs which are used as biological tags or in techniques used in the development of drugs.

By using the examples of carbon and gold we can see that when nanoobjects are inserted into more complex materials they improve the quality of the material. There will be an increase in the number of innovative materials in the future which will be developed for their thermal and electrical qualities, for their mechanical resistance, or simply for their new properties.

6.2. Ground-breaking products

In the next chapter, which introduces the topic of MEMS (Micro Electro Mechanical Systems), we will see how the process of miniaturization has made its way into mechanical and electromechanical devices by using top-down techniques stemming from microelectronics. It must be made clear that the introduction of nanoobjects into materials, as described above, gives new properties to traditional products. Two types of application can be distinguished.

6.2.1. *Surface treatment*

The treatment used in order to make surfaces self-cleaning, in particular glass, is known as the lotus effect. This flower, a symbol of beauty, has a superficial hydrophobic molecular layer made of nanometric-sized hairs on which the tiny water droplets slide, removing any dust particles; as a result the flower retains its shape.

The bactericide properties of silver particles are used to coat medical appliances and washing machines.

The creation of deposits of polymer layers leads to the development of molecular *mille-feuilles* (molecules with a thousand layers), which are used in surface protection and pressure sensors. These molecules are being used in more and more applications.



a)



b)

Figure 6.4. *A lotus leaf and the lotus effect*

a) The lotus is a plant in India whose sacred character is linked to the immaculate appearance of its leaves. One property of the lotus leaf relates to the manner in which water runs off it, thanks to its nanometric-sized hairs that line its surface. These water droplets remove any dust particles, thus acting as a self-cleaning mechanism which gives the lotus leaf its unaltered shape.

b) Certain types of technology are inspired by this kind of nanostructure for the treatment of hydrophobic and self-cleaning materials; this is known as the lotus effect as illustrated by this millimeter-sized drop of water on a hydrophobic textured under layer. The drop of water keeps its pearl shape (a very hydrophobic material). The texture is a regularly-organized lattice of micron-sized blocks which gives the material its colors. The super hydrophobic property is called the lotus effect (CNRS, French National Center for Scientific Research, Thema, no. 5, 4th term 2004).

6.2.2. *Incorporation in a composite environment*

Recently, the automobile industry has been the forerunner in the use of polymer nanocomposites reinforced with nanoparticles. An anti-streak polish for cars, which is made with silica nanoparticles, gives car bodies excellent mechanical resistance, a lasting shine, and the toughness of a diamond.

Carbon nanotubes are found in new generation tennis rackets, bicycle frames, and other sport materials, which means lighter equipment and better performances.

In the textile industry, nanotubes are used for the production of high performance bullet-proof vests. The fiber modifications on a nanometric scale lead to a considerable improvement of the fabric, in terms of thermal comfort, the ability to create clothes that do not need to be ironed, protection against stains, and better hygiene due to the incorporation of antibacterial nanocontainers.

The cosmetics industry is just as active in this field and is attracted to the opportunities offered by the nanoworld, especially in skincare products. Microspheres of biodegradable polymers allow for the release of vitamins that bring more elasticity to the skin. Cosmetics use fullerenes to fight skin aging.

It is believed that there are at present more than 200 products containing nanotubes available, such as sports accessories, clothes, and cosmetics, all of which can be purchased in major outlets.

The pharmaceutical industry is a sector in which nanotechnologies offer new perspectives. Certain drugs can be placed into nanocapsules which serve as vectors in order to reach sources of pain in the human body or which are able to offer better absorption and temporary relief.

6.3. From micro to nanosystems

6.3.1. *Miniature components – MEMS*

In the field of electronics, generations of machines that deposit and engrave thin layers of metal have succeeded one another for decades. The mechanical industry has not only been able to use products stemming from these new technologies (eg in watchmaking), but has also been able to make its own miniaturized products with the same tools. Several appliances that are used by the general public, which illustrates this convergence of microelectronics and micromechanics, will be discussed later in this chapter.

6.3.1.1. *A print head for inkjet printers*

Modern printing is the successful result of a technological revolution; this is the passing from the analogical era to the digital era, from mechanical miniaturization to the creation of submicronic integrated components.

Originally, the characters on typewriter keys were printed by transferring the ink from a carbon ribbon onto a page by pressing with a metal design. Printing was mechanical; then it became electronic. The introduction of electronics meant the arrival of machines with a single spherical typeball which moved laterally along the line to be printed. The number of printed characters on the typeball was limited and had to be changed for each different print style. With the advances in information technology then came the dot matrix printer, in which each selected character comes from certain elements of the matrix. In the case of the modern inkjet printer, the carbon interface has disappeared in favor of nozzles (up to 256 per print head) which project several picoliters of tiny drops of ink onto the paper by using thermal or piezoelectric pulses. The creation of these print heads requires the same technology as that used in microelectronics.

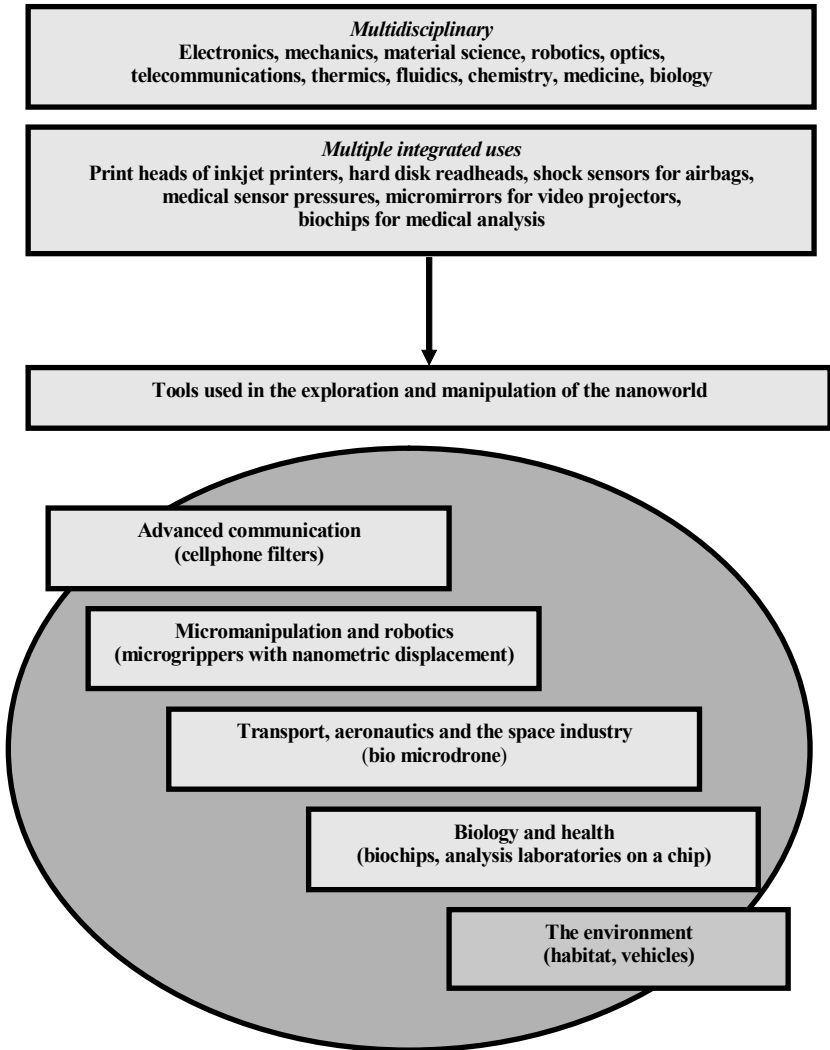

Figure 6.5. MEMS

This succession of innovations has led to the development of products which are lighter, faster, more reliable, of a better quality, and can be produced at a lower cost. Today, inkjet printers are inexpensive to purchase.

6.3.1.2. Airbags

All modern cars are equipped with a device designed to save lives in case of a collision. This device is known as the airbag. Only under precise deceleration conditions is the airbag meant to go off instantaneously. The airbag sensors that send a signal to fire the pyrotechnic inflating mechanism must meet certain standards and this is made possible by modern technology.

A large range of products uses the same sensor movements or gyrometers.

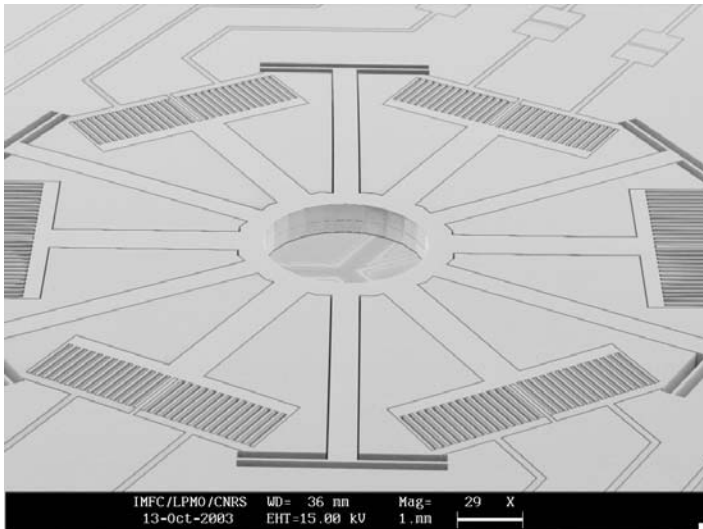

Figure 6.6. *A microgyrometer: a microgyrometer is an integrated sensor that measures the rotations of a moving object*

6.3.1.3. A microlens for miniaturized optics

This component provides interesting possibilities for autonomous miniaturized investigation devices (eg microcameras); although for the moment the applications used in digital imaging are of much larger dimensions than those in the nanoworld. Microlenses use an electric field to alter the curve of a droplet. A variable focal length microlens can then be created.

Microfluidics will exploit the principle of microdroplet distortion by polarization.

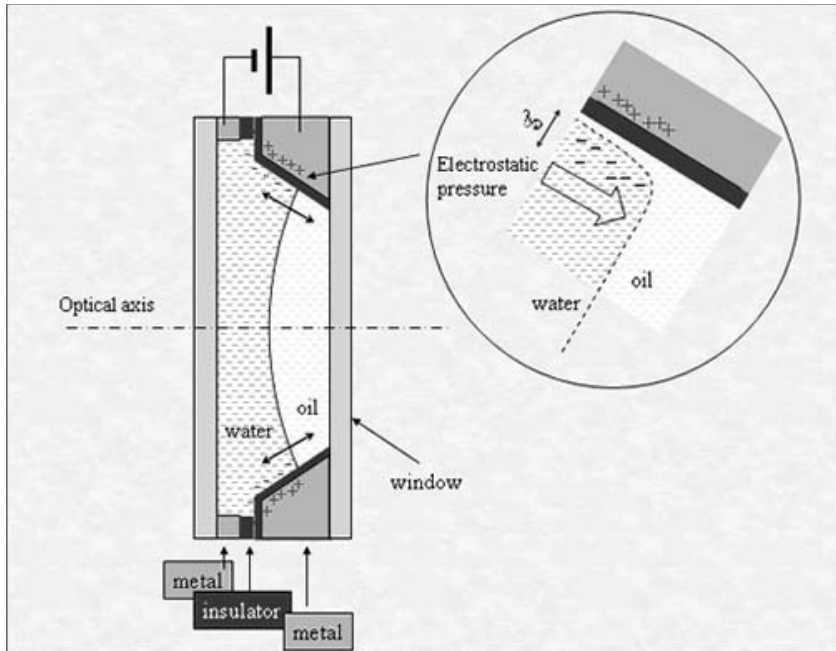

Figure 6.7. *Microlenses: the curve of the water/oil interface that determines the focal length depends on the electrostatic pressure introduced by the polarity of the electrodes around the lens*

6.3.1.4. *Magnetic disk readheads: quantum nanostructures*

The magnetic readheads benefit from the discoveries made in an area of electronics linked to the associated magnetism of the electron, in other words spin. The giant magnetoresistance effect, a relatively straightforward concept, is used in the creation of nanostructures. When two conducting ferromagnetic layers⁵ are separated by a non-magnetic ultra thin layer (at a nanometric level), the current that passes from one layer to another depends on their magnetic configuration. An exterior magnetic field, in this case the one produced by the information bits on a hard disk, can cause a strong variation in the electrical resistance. This very good example of the association of thin-layer technology and basic scientific knowledge is only one representation among many of this new science known as spintronics.

In work spaces or workstations of research laboratories, a substantial number of innovations are being proposed which are widely accepted by the large information technology market that exists today.

6.3.2. *Microsources of energy: key points for embedded systems*

This is a strategic field. The variety of uses for different types of energy leads to the creation of more or less miniaturizable devices. Once again, nanotechnologies are brought into play through new materials such as catalysts for chemical converters and nanoporous membrane for fuel cells.

Certain types of generators that transform vibrations into electrical energy use the same techniques that are employed in microelectronics.

⁵ Magnet properties.

Thanks to microenergy sources, various opportunities have arisen in the medical field. The main problem is producing energy from the resources available in the human environment. Will it be possible in the near future to use the properties of certain bacteria or certain enzymes in nanogenerators?

The use of tools stemming from the worlds of nanotechnology and biology should result in a new generation of biological fuel cells. Certain bacteria or enzymes in nanostructured membranes are used in order to produce hydrogen. The point here is, of course, to be able to get these biological fuel cells to function in living organisms, in particular in humans, by providing the fuel they need.

Will such a thing as artificial mitochondria exist in the future?⁶

6.3.3. *Micromotors*

Chemists can also synthesize molecules propelled by light. At the moment chemists are, however, far from exploiting these accomplishments for any practical use.

On the other hand, some chemists have achieved truly outstanding results, such as a nanocar with wheels and molecular axles which was recently created. Apparently it actually works.

⁶ Each cell of the human body contains mitochondria which transforms glucose into ATP (adenosine triphosphate).

The first molecular nanocar.

Researchers at Rice University (Houston, Texas) have synthesized a molecular structure that resembles a car. The nanocar, as its inventor James Tour calls it, consists of a “chassis” and two “axles”. The latter are made of organic molecules with chemical groups chosen so that the “axles” turn freely around the “axe”. The four wheels are in fact buckyballs, ie fullerenes. These molecular structures of 60 carbon atoms were discovered at Rice University by the Nobel Prize winner for Chemistry, Rick Smalley. The nanocar measures 3 nm x 4 nm. It drives just like a normal car in that it moves perpendicularly to the axle driven by the rotation of its wheels. The production of this car and the study of its movement on a surface made of gold were carried out with a scanning tunneling microscope (STM). The images of the structure taken by the STM at regular intervals show that the nanocar moves perpendicularly to its axle. Furthermore, when positioning the tip of the STM on the surface, the researchers observed that it was easier to move the car in the direction of the rotation of its wheels than to push it perpendicularly.

One major difficulty was to synthesize the car’s complete structure. Fixing the fullerenes to the axles turned out to be particularly challenging. The know-how gained by Professor Tour’s team lets them now consider the production of other structures such as a nanocar with a light-driven engine or other molecular vehicles capable of carrying cargo. Apart from generating much attention in the media due to the comparison with normal cars, the researchers from Rice University discovered how to master molecular movements on a surface. This was a major step forward in the development of nanomechanisms⁷.

⁷ This information is an extract from *BE Etats-Unis*, no. 10, November 17, 2005, written by the French embassy in the USA.

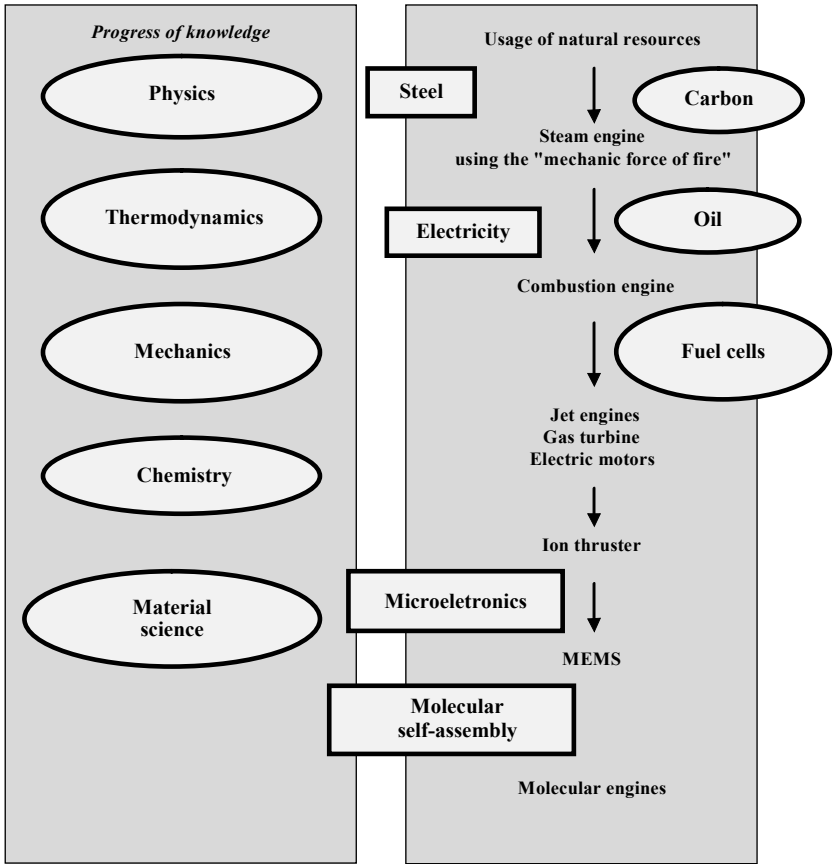

Figure 6.8. Engines

The example of the nanocar still somewhat belongs to the realm of science fiction. However, nanomaterials are currently used in the miniaturization of certain engines (eg micropumps, microturbines) that are used in medical applications, for example as prostheses, or in astronautics.

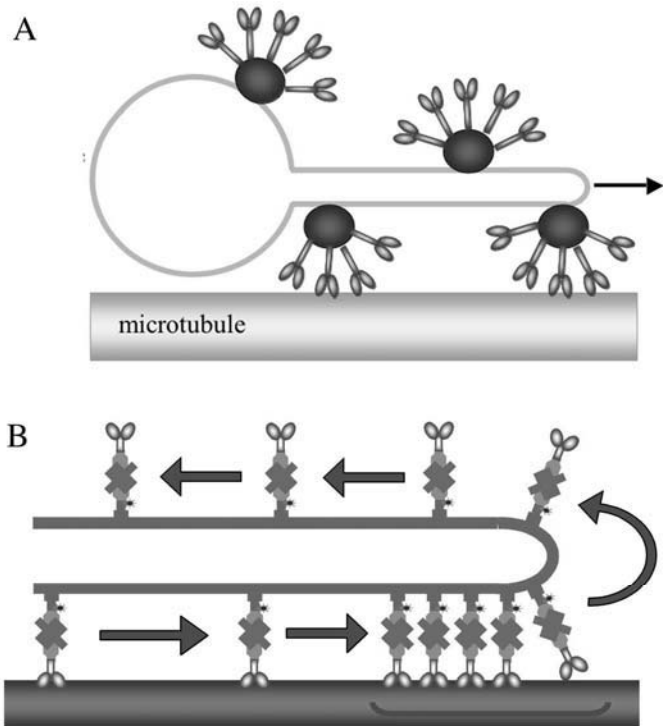

Figure 6.9. The motor molecules behind the intracellular network, carried out *in vitro*

In the nanometric domain the only engines are of a biological nature. Nature formed specialized molecular structures, such as kinesins. These are true linear motors that take chemical energy and transform it into a mechanical force. Kinesins are a class of motor protein that transport cargo about the cell.

A. Molecular motors or kinesins are attached to the vesicles' membrane by microtubules. They use ATP to move along the microtubules; by doing so they alter the shape of the vesicles' membrane.

B. These motors can directly link to the lipids by streptavidin. The motors at the end of the tube exert a tractive effort and move more slowly than those behind them, thus creating an accumulation of motors at the extremity of the tube.

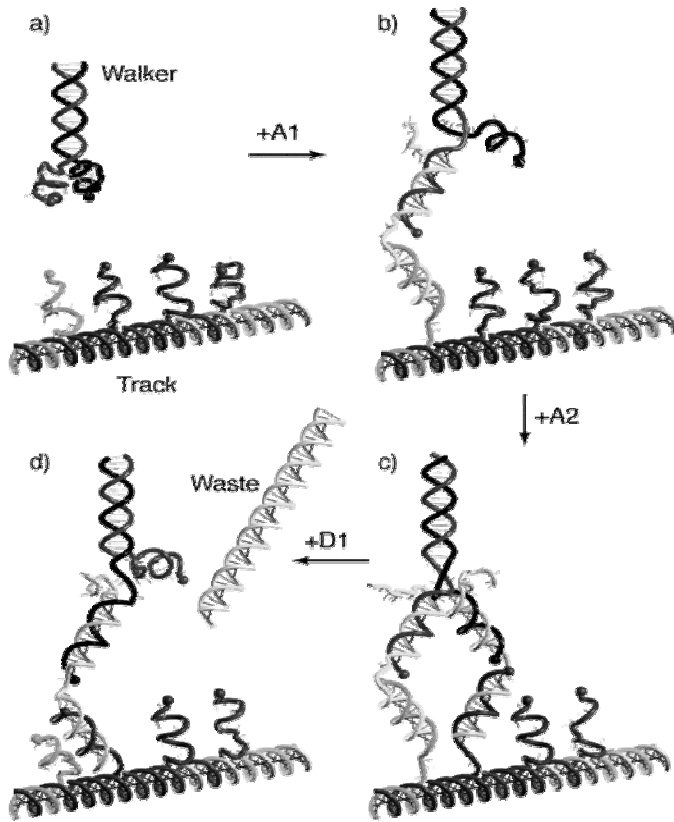

Figure 6.10. *Walking molecules*

Explanation of the mobility of the biped walker:

This system has four components. These are a walker, a track, and two different kinds of combustible DNA sequences: attachment strands (A1, A2) and detachment strands (D1). On the track, the DNA's branches enable the walker's legs to attach themselves via bonds A. Then the addition of other components to these bonds allows their elimination under the form of an AD duplex (waste). This system imitates the movement of the kinesins on the microtubules.

a) walker free; b) walker bonds to the branch by an attachment strand; c) walker bonds to branches 1 and 2 by attachment strands A1 and A2; d) walker disconnects from branch 1 by adding detachment strand D1, which leads to the creation of waste.

Some products are so extraordinary that they seem to belong to the world of science fiction. For the past 18 months, SilMach⁸, a company that specializes in the exploitation of the results of scientific research, and which is also a spin-off of the CNRS and the University of Franche-Comté, has been working on an extremely small unmanned aerial vehicle (UAV). This UAV is based on a living organism, a dragonfly.

The DGA⁹ signed a research contract with SilMach. The research into the artificial dragonfly has taken its inspiration from biology. This project is a real breakthrough that opens up new perspectives in the field of minaturization due to its size. Being a result of this innovative research this machine's only purpose is to serve as a nano UAV. In total it weighs 20 mg and is 6 cm long. The dragonfly developed by SilMach is made entirely out of silicon.

(DGA)

The list of examples of micro and nanosystems invading all areas of human activity is neverending. These technologies will bring about a revolution, particularly in the medical field and especially for diagnosis. It is evident that in the near future it will be possible to introduce microscopic probes into the human body. These probes can then investigate problems and collect information by saving it or transmitting it to the outside. The resemblance between this type of technique and that of UAVs, such as the previously mentioned dragonfly, is evident¹⁰.

8 <http://www.silmach.com>.

9 Ministry of Defense. For further information on this project, see <http://www.defense.gouv.fr/site/DGA>.

10 The problem of hybrid as well as self-reproducing nanosystems, made of both silicon and biological matter, is described in Michael Crichton's techno-thriller *Prey*. This type of novel could cause the public to fear nanotechnologies.

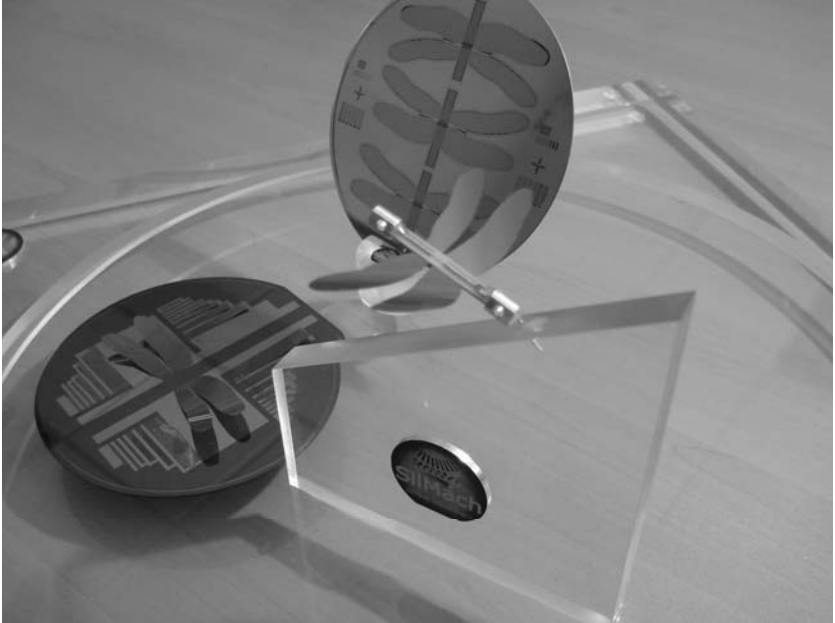

Figure 6.11. *An artificial dragonfly*

This is not child's play.

"This system of flapping wing propulsion developed by SilMach has a mass of 20 mg. The MEMS microbatteries developed by the CEA weigh another 100 mg. This micromechanic system has 180,000 integrated artificial nanomuscles which make up 9 mg of weight at the surface of the wings. The wings develop a mechanical force of 80 mW for only 2 mg of the integrated microengine."¹¹

11 Extract from *Le Journal du CNRS*, no. 186, July-August 2005.

6.4. A global integration

What are we witnessing?

The development of new technologies goes hand in hand with the installation of ever more complex information technology systems. Both of these lead to a change in human relationships and increase interaction between different societies. On a technical level, nanotechnologies will make the obtainment, processing and storage of data more complex.

In the case of MP3 players, computers and televisions, the number of available functions is multiple since they are all digitalized. A cellphone can now be used as a web terminal, a camcorder, and a payment facility.

The radio frequency identification (RFID) is able to read and store data from a distance by using radio-tags¹². Built into products, they allow the products to be managed and traced from a distance. However, this technical innovation could also be used to trace humans and their access to transport, workplaces, etc. Used on passports or intelligent barcodes, RFID is a remarkable tool which could, however, put people's privacy at risk if it is misused. This idea will be broached in the final chapter when considering ethical problems. The linking of databases, as well as processing and transmitting data, will create problems everywhere.

In health care, everyone should have access to the best medical provision available and access to an up-to-date version of their medical file.

¹² Radio-tags consist of an antenna which is connected to a computer chip that enables it to receive encoded radio signals and reply to them through an external transmitting and receiving device. Radio-tags do not have their own energy source. Energy is supplied by the received signal.

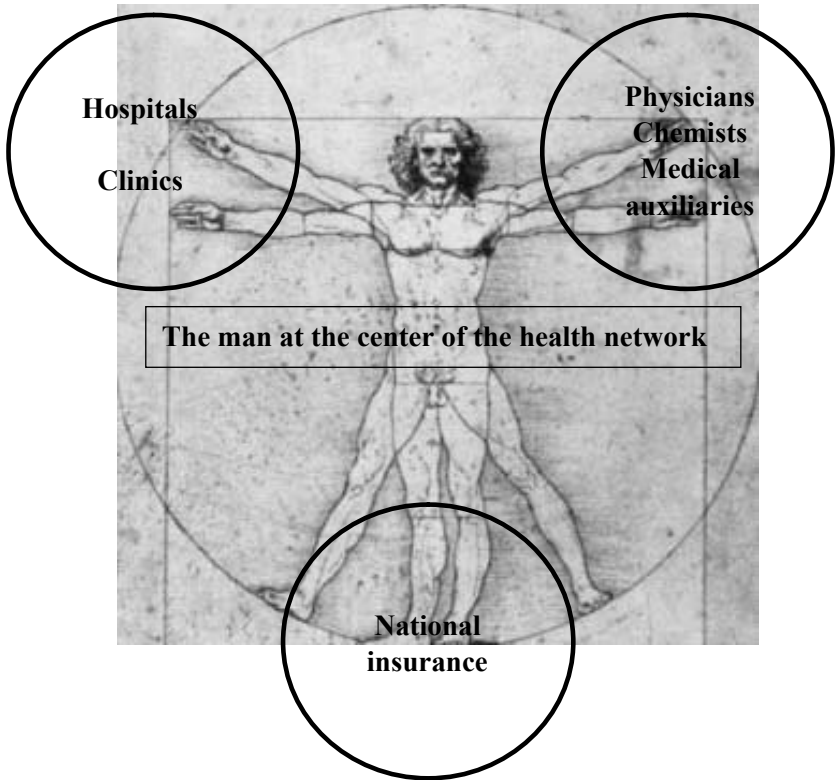

Figure 6.12. *The health care system*

Let us take another look at the global positioning system (GPS)¹³. Initially, this satellite positioning system was used by the US military. Now applications have made their way into society. In fact, it was a maritime navigation tool and then, with the appearance of digital cartographic databases and low-cost devices on the market, it made its way into the car industry. Since then, drivers have had their own digital guide. Working with urban

¹³ This navigation system is increasingly used and is continually being developed in the car industry. In the future, it will be essential for finding an open convenience store in order to buy some milk. At the moment, it mainly indicates the route, petrol stations, and speed cameras.

sensors, the GPS optimizes travel and even warns the driver of speed cameras. This rapid technological evolution is a perfect example of the development of a rising market.

Our means of transport on land, air, and sea use nanotechnologies in their equipment and in their structures. They therefore also take part in the global integration of complex systems.

Cars

Of course cars, just like boats, are equipped with electronics on board, such as GPS. The car is probably the object with the most technical innovations that stem from nanotechnologies and which is used by the general public on a daily basis. The examples are multiple and range from hydrophobic windscreens to catalytic converters to electroluminescent diodes.

Airplanes

As aeronautics is the field that uses state of the art technology more than any other, nanotechnologies can of course also be found in two main sectors of this field, in electronics and information technology, as well as in materials. For the A380, the world's largest airplane, two different kinds of new materials were used. They were chosen because of their resistance against corrosion and fatigue, as well as the fact that they are very light. The first one was CFRP (carbon fiber reinforced plastics), a composite material of plastic reinforced by carbon fibers. The second material is called glare, a glass-reinforced fiber metal laminate. As a result of the usage of these two materials, the A380 is much lighter than other airplanes and meets the most rigorous safety standards.

Sailboats

Sailboats benefit from the latest innovations in the field of nanosciences; navigation is assured by GPS, security by Argos Beacons¹⁴ and communication by satellite telephones and webcams.

Hulls and masts are made from carbon fibers, composite materials and pre-impregnated carbon. The sails are made of kevlar, whose rigidity, which is stronger than that of steel, is due to a network of hydrogen links between polymer chains. From antifouling paint to the treatment of superstructures, surface treatments are omnipresent. Teams of skippers use nanopore textiles which give the best thermal protection with increased comfort under strenuous conditions. Intermediaries between the most advanced laboratory techniques and products developed for the general public mean that certain sailing boats, even hovercrafts, are learning to fly.

Eventually houses of the future will be constructed using all of these technological innovations.

14 Argos is a satellite-based database aimed at studying, monitoring, and protecting the environment. It was brought into use in 1978 by CNES (the French Space Agency) and the two American sister organizations (NASA and NOAA). This system enables the calculation of the position of mobile objects and the picking up of some of their transmitted measurements by using small, automatic, radio transmitters. In 2007, more than 8,000 Argos transmitters are in use all over the world.

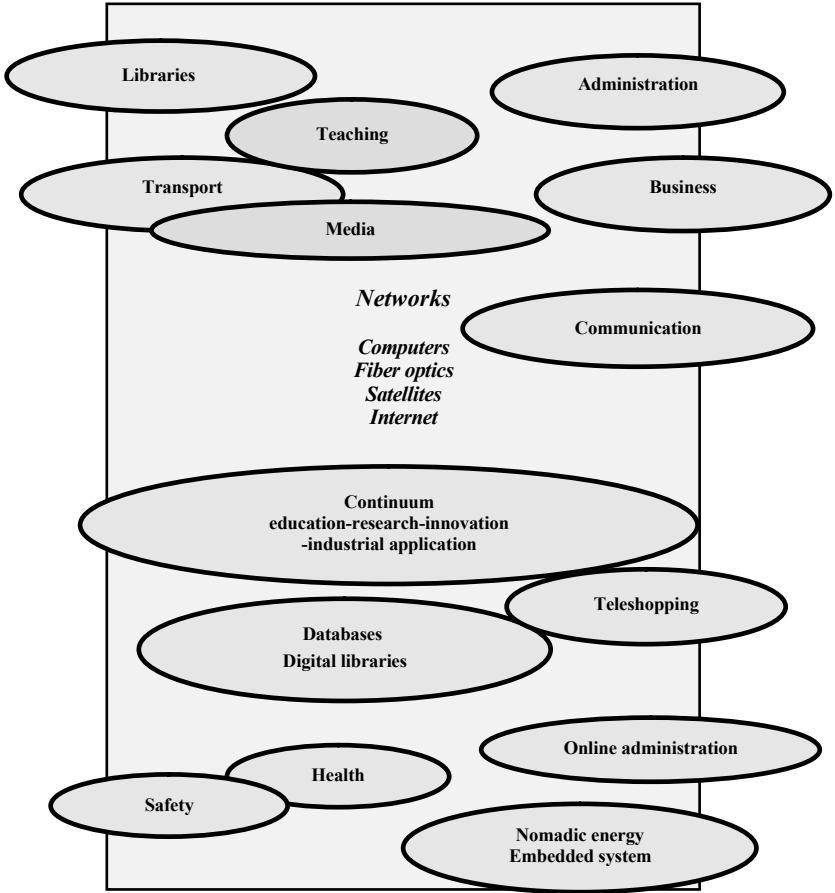

Figure 6.13. A global integration

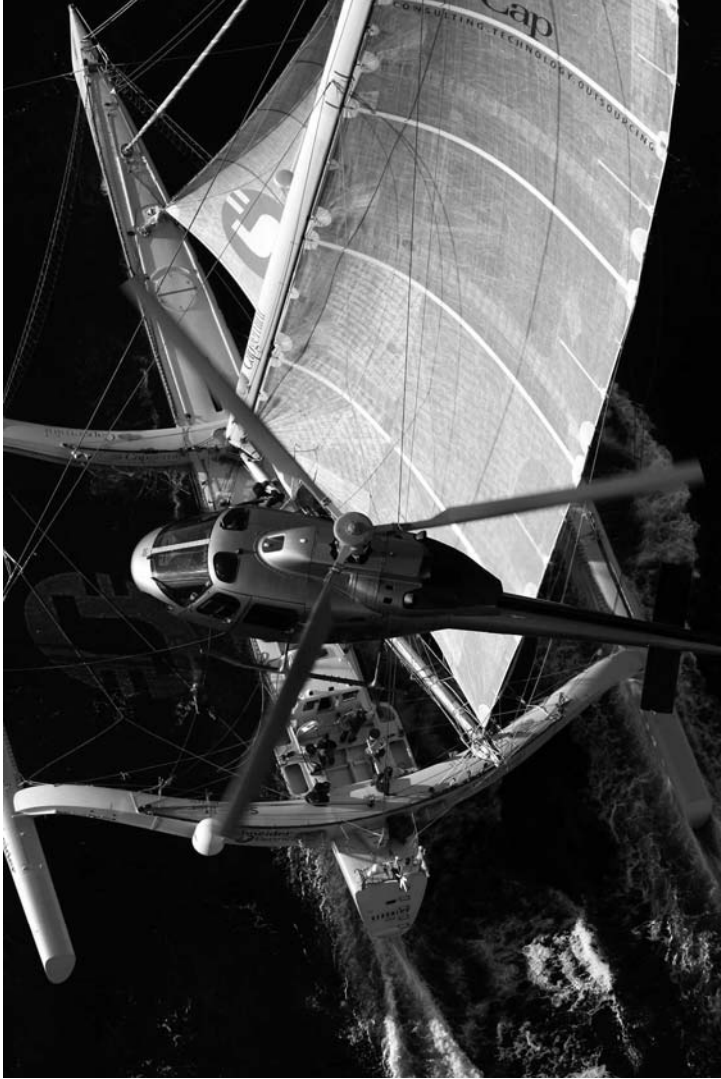

Figure 6.14. *Geronimo (Kersauson's yacht)*

New materials continue to enhance the performance of sailing boats and range from prototypes produced for professionals and used in competition to standard versions used by the general public.

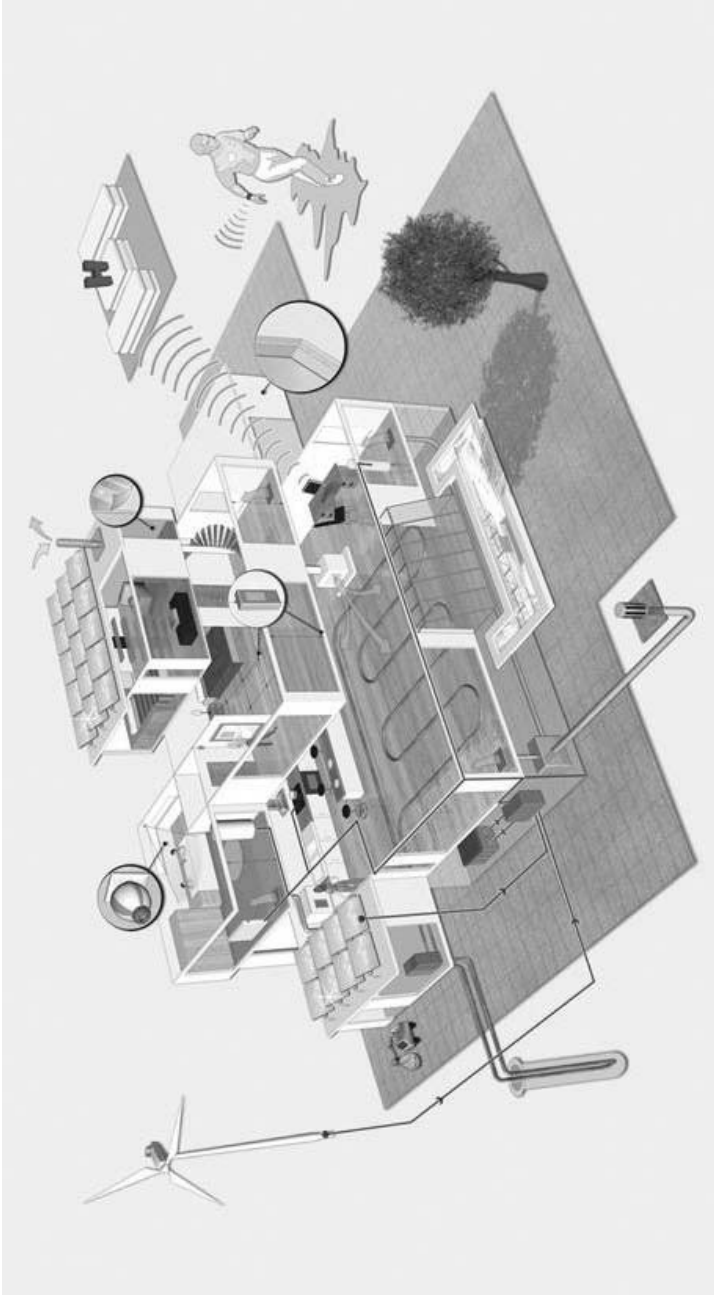

Figure 6.15. *A guided tour of a house in the future. Where are the nanotechnologies hiding?*

6.5. Some bonus material for engineers

Job title? Specialist in digital microplumbing!

The manipulation of fluids on a micrometric scale is already used in several fields of mass production. In chemistry and biology, lab-on-chip systems analyze very small quantities of products. In the field of electronics, inkjet printers have gone into mass production. The circulation of fluids in pipes is conducted by mechanical or electrokinetic pumping, which consists of simply altering the size from those produced by traditional technology, even if the pipes are made of silicon.

A new approach called digital microfluidics allows fluids to be handled in microquantities in droplet format. Electrostatic forces control the movement of these droplets just as unit-sized packets of electrons are controlled in the field of digital electronics. The system is very similar to that of a digital circuit which means that droplets can be detected, moved from one place to another, added onto each other, or split apart. Benefiting from the technologies developed for microelectronic circuits, digital microfluidics is inciting a revolution in the lab-on-chip technology, whose field of application is considerable.

Even fluids are affected by the digital revolution¹⁵!

¹⁵ For further information, see “Instrumentation pour la biologie”, written by Claude Vaucher for the scientific journal of the OMNT (Observatory for Micro and Nanotechnologies). This article is an overview of the year 2004 and was published in 2005.

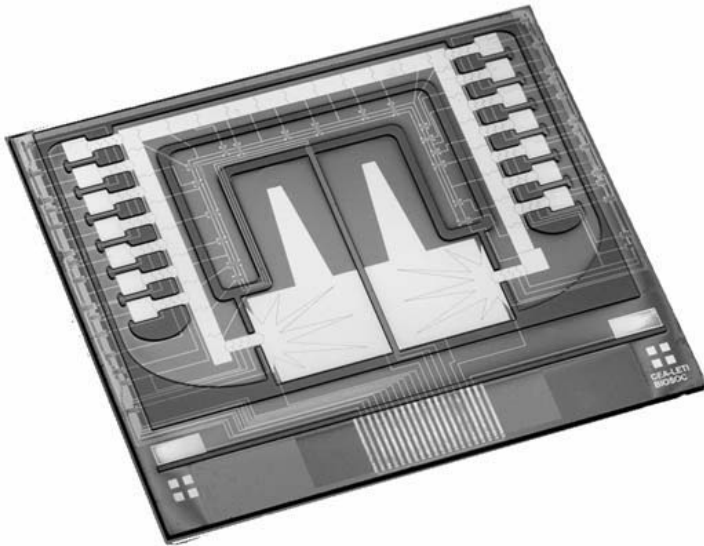

Figure 6.16. *Microfluid chips (electrowetting)*

From the Royal Library of Alexandria to digital books

Major libraries have always been sources of knowledge. This aura of knowledge attracted academics and scholars. Founded in 332 BC by Alexander the Great, the Royal Library of Alexandria was the heart of a center destined to academic research. Numerous volumes of great value, which were unique, were destroyed in several fires that struck the library before its final destruction in 642 AD. Nearly 2,000 years later the Bibliothèque nationale de France (BnF), the National Library of France, a new prestigious complex which opened in 1996, took on the role of the guardian of cultural heritage. However, its fame is not only linked to its collection, which attracts researchers, as well as a large number of readers, but also to its enormous database which links up to the entire world.

New technologies have partly taken over the role of paper with digital libraries, whose data is much more secure¹⁶, available to anyone, anytime, anywhere.

16 Gallica: <http://gallica.bnf.fr>.

What is true for written data also applies to sound and image. New technologies generated by the spectacular evolution of electronics are revolutionizing the media and also the business world. In the creation and transfer of knowledge, everything used to be printed on paper. Newspapers, journals and books were all printed and distributed or sold via various distribution channels. These means of communication have not disappeared; however, the digital network has established itself as a parallel distribution channel. Fast access to information and the digital network as a distribution channel are now essential. Academics are creating their own networks and challenge the publishers on the level of publishing rights and cost¹⁷. Some American universities overthrew the old system of scientific journals by publishing all of their research results online¹⁸. Free access to information and the almost endless possibility of creating statistics have profoundly changed the habits and rules in research, including the decisions about what is published. This includes peer reviewing which normally ensures and observes the quality of what is published in the main scientific journals.

It has become easy to carry out follow-up studies on the impact of research results, changing the evaluation criteria which consequently have an impact on the career of researchers and lecturers. A global world of digital universities and digital networks has emerged.

These are some of the previously unimaginable consequences of the alliance between the computer chip (flea) and the (spider's) web¹⁹!

17 The CNRS cooperates with the INIST (Institute for Scientific and Technical Information) <http://www.inist.fr>. Universities cooperate with the ABES (Higher Education Bibliographic Agency) <http://www.abes.fr>.

18 Nearly all of the main American universities publish the results of their research online (open access), with different options for a printable version. In the health care sector, the NIH (National Institutes of Health) applies a similar policy on a government level.

19 In French the word for chip “puce” has a double meaning and may also describe a flea. In French a play on words describing the link between the chip and the web as a flea caught up in the spider's web is a very funny comparison.

This page intentionally left blank

Chapter 7

Nanos are Changing the World

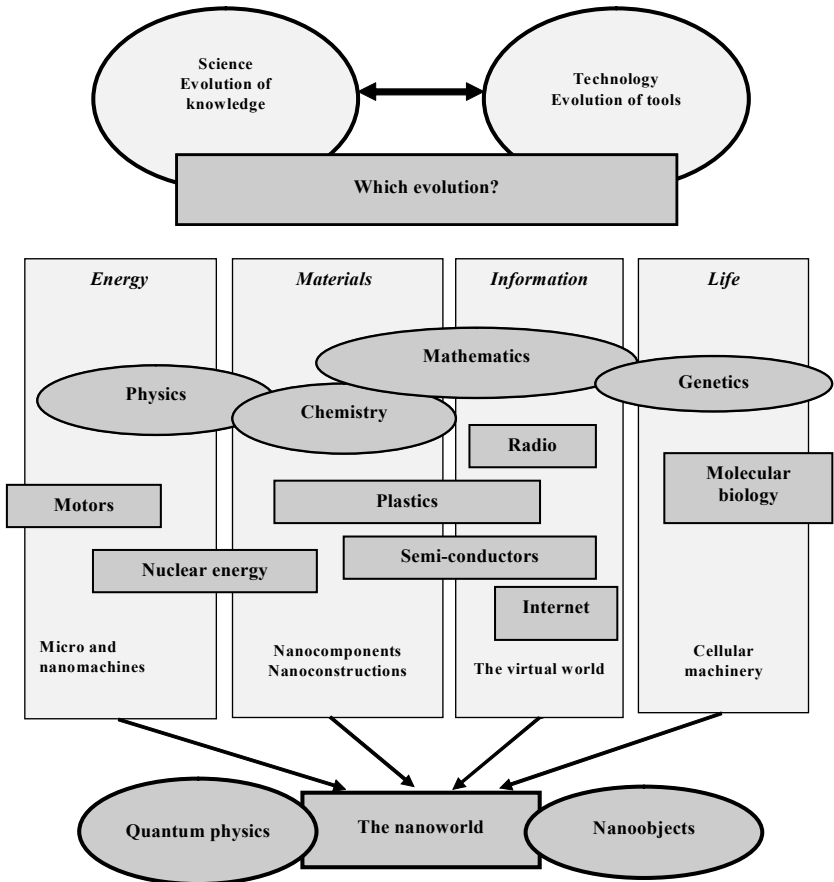

7.1. A simulation or a virtual world

Dreams are sometimes so realistic that they seem to take place in the real world. The brain, an incredible network of billions of interconnected neurons, allows us to have the impression of experiencing seemingly impossible situations. Who has never flown in their dreams? This simulation becomes possible in everyone's dreams.

The nanoworld exists within computers. Miniaturization of devices and their massive integration into systems continually increases our ability to calculate, increases the speed of information retrieval from databases, and allows for a virtual representation of physical objects or complex systems.

Simulation is used to analyze how products react to different situations before their construction (eg planes, vehicles), to determine the parameters used in the production process and to predict the results before starting production (eg integrated circuits). In other words, to test the products in a thorough and rapid manner without the costly risks for those who finance the projects. Computer-aided design (CAD) helps humans to manage complex systems.

CAD enables us to predict the future. Weather forecasts, for example, predict the weather in the short term and have enough precision to allow us to implement the necessary precautions in a worst case scenario, as is the situation with storm forecasting.

Simulation has become an indispensable research tool which enables all physically impossible experiments to be carried out to test any given theory. As with the problem of global warming, the long-term global projections are carried out using models that have been tested for their capacities to reproduce past climate changes.

Simulation is a powerful tool and a product of the nanoworld. However, the roles have become reversed since simulation is now used to study the nanoworld. Nanostructures lend themselves to digital analysis. With regard to the limited number of atoms that make up these models, they can be extremely realistic which becomes ever more complicated when trying to create a simulation of larger objects. The field that makes most use of these types of simulations is molecular biology.

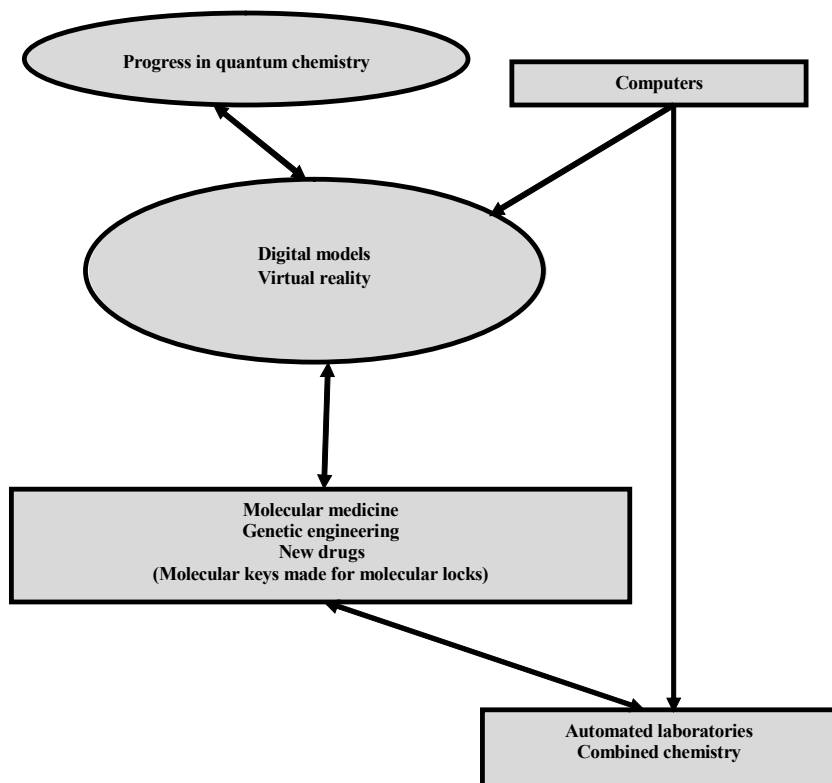

Figure 7.1. *Virtual reality*

Three-dimensional (3-D) visualization and interactive programs have enabled a nanometric representation of the world, as well as the possibility of manipulating it and moving objects within it. The

tools of simulation are the basic tools of chemists, more precisely biochemists. It is much easier to manipulate a virtual protein and understand its functionalities than to manipulate it through an atomic force microscope.

Given the complexity of quantum physics, simplifications are necessary for its application on a practical level. Models enable the visualization of molecules, including their dynamic reactions, and help researchers understand their exchange mechanisms. This approach is particularly useful in the discovery of new drugs. To see the form of a virus and to observe how it penetrates cells may enable scientists to develop new drugs to combat it. It is therefore easier and less expensive to create active molecules. The development of a new medicine demands considerable investment and the use of CAD which has become an essential tool for research and development.

Generally speaking, we are looking to simulate the cell and a more complex biological system:

Researchers from the Institute of biomolecular conception at the University of Alberta are in the process of creating a virtual cell generated by a computer. This cell will be a replica of the *Escherichia Coli* bacterium which was chosen for its basic structure. Thanks to its structure, researchers hope to have a better understanding of how cells function and to discover a faster and more cost-efficient method of developing new drugs.

The simulation of the *E. coli* cell is only the first stage in a large project known as Cybercell. Its aim is the simulation of more complex living organisms.

However, we will probably have to wait until 2010 before a perfect virtual cell is available. This simple *E. coli* cell is made up of more than 100 million biological molecules and involves about 20,000 different chemical reactions¹.

¹ This information is an extract from *BE Canada*, no. 227, June 10, 2003, written by the French embassy in Canada.

IBM is going to create a model of a neocortical column. IBM is working on a research project with the Swiss Federal Institute of Technology in Lausanne to try to create a better model of the neocortex column. They hope to have a better understanding of certain psychological problems, brain diseases, the human memory, and the brain's ability to learn. The results being used were taken from research carried out over several years on the neocortices of rats. They want to create a 3-D model of the neocortical column cortex which is a part of the neocortex. In a rat the neocortex column contains 10,000 neurons; it is estimated that the human neocortex contains approximately 10 million neurons. This project, known as Blue Brain and which is ranked ninth in the world and is directed by Charles Pack from the TJ Watson Center of Research, uses a Blue Gene supercomputer which has a maximum processing rate of 22.8 teraflops². This system was installed last summer in Lausanne, Switzerland. The goal of the project is more ambitious than anything that has been carried out before now. Up to two terabytes can represent 10,000 neurons. The database contains a description of all the neurons and their electric interactions including any applicable changes found in experiments (the Swiss Federal Institute of Technology defends the idea that the brain reorganizes information on a regular basis). Simulation researchers will construct a 3-D model of the column in which all the aforementioned interactions between neurons will be simulated; after which time they will compare the model against the data taken from the experiments carried out previously. First of all, a model of virtual columns is created. Grouping these together leads to the neocortex model; this in turn leads to the creation of an entire brain. The team predicts a timescale of two years to perfect and calibrate the model. Simulating the functioning of the brain and using this simulation to develop treatment for brain diseases remains a technological challenge. In cooperation with the TJ Watson Center of Research, IBM aims to prove and test Blue Gene's capabilities and to pave the way for the future³.

2 This corresponds to trillions of operations per second.

3 This information is an extract from *BE Etats-Unis*, no. 9, November 10, 2005, written by the French embassy in the USA.

Ever smaller objects are continually being produced in order to observe the molecular world and to work within it. Scientists plan to virtually represent the molecular world on a real world scale⁴.

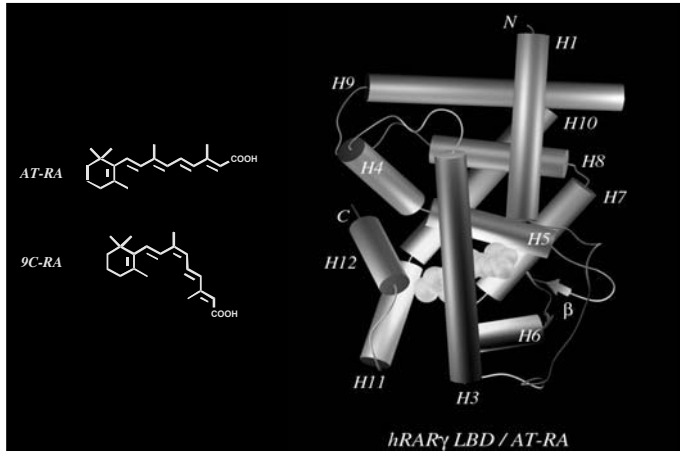

Figure 7.2. *The nuclear retinoic acid receptor*

The nuclear retinoic acid receptor (located in the nucleus of a cell), a derivative of vitamin A with its ligand. The figure shows the 3-D structure of the ligand, a protein containing approximately 300 amino acids, through a simplified representation. This protein is composed of 12 alpha helixes, each represented by a tube and linked together by loops of different length. Retinoic acid is a natural ligand of the nuclear retinoic acid receptor. It is found in the heart of the protein which is designed to recognize this acid in a specific manner. The left part of the diagram shows the chemical formula for retinoic acid and that of an isomer 9-cis.

⁴ To find out more, refer to *Research*, no. 393, January 2006, “High Performance Calculation”.

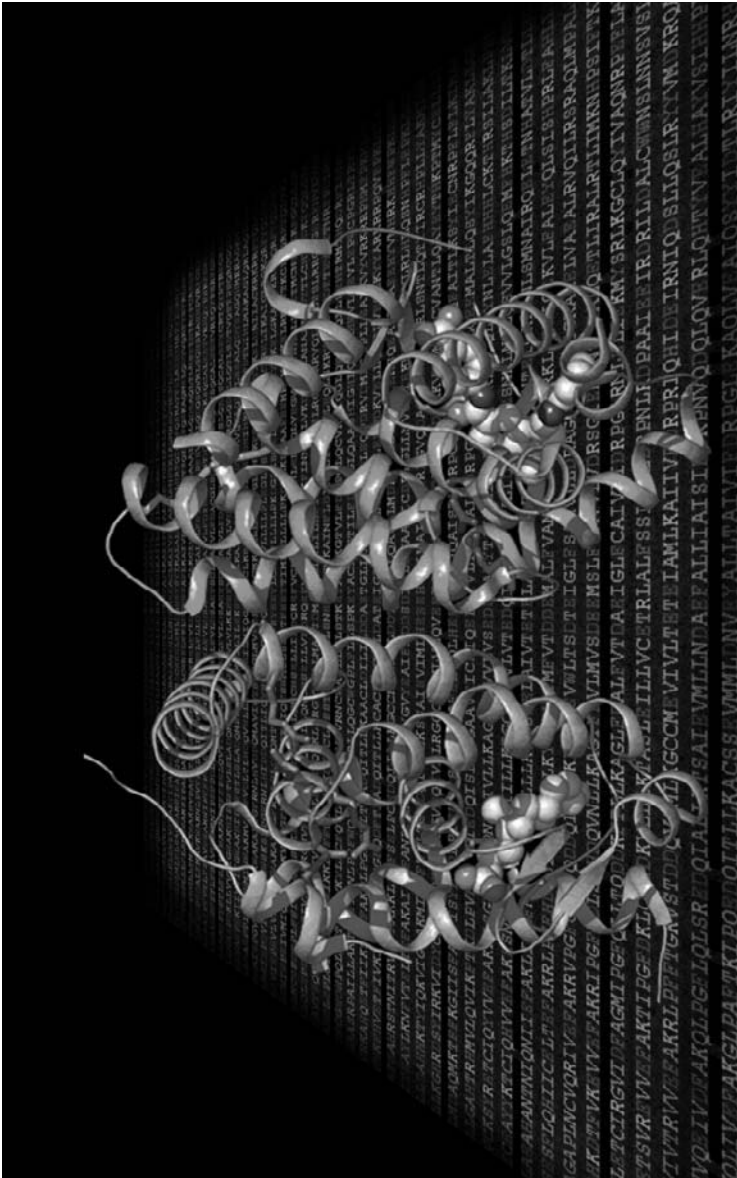

Figure 7.3. A 3-D structure of the complex RXR-RAR function (Retinoid X Receptor-Retinoic Acid Receptor). The diagram shows the heterodimer associating the two nuclear retinoic acid receptors in their active form (stable ligand)

7.2. Understanding nature

Humanity is extending its understanding and control in the fields of energy, materials, information, and life.

7.2.1. *Understanding energy*

Fire dates back to man's origin, but the quantum leap leading to the development of machinery and the industrial era begins with *Reflections on the Motive Power of Fire* by Nicolas Carnot in 1824. Coal, oil, electricity, nuclear energy and now renewable energy sources feed our ever-growing energy demands.

Solar energy, energy storage and nomadic power supply systems have arisen from developments in micro and nanotechnology. Furthermore, new materials are indirectly contributing to energy conservation.

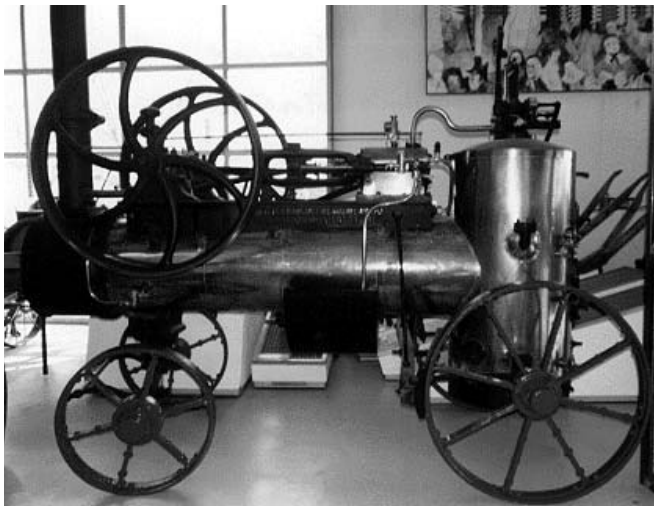

Figure 7.4. *A steam engine constructed in 1928*

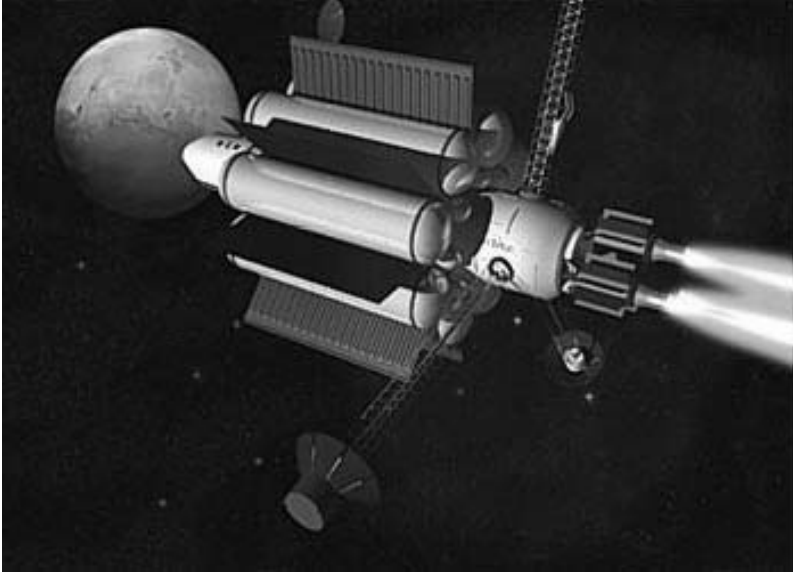

Figure 7.5. *The magnetoplasma rocket VASIMR (Variable Specific Impulse Magnetoplasma Rocket). Advanced Space Propulsion Laboratory NASA*

7.2.2. Understanding materials

Mankind has always used and created new materials. Ceramics appeared in the Orient in 10,000 BC, followed by the Bronze Age (around 2,500 BC) and the Iron Age (around 1,100 BC). However, industrial development is far more recent and is linked to energy development and, to a greater extent, oil and plastics.

Our most modern technologies enable the production of materials whose exceptional properties, be they in optics, magnetism, mechanics, or electronics, stem from their nanostructure.



Figure 7.6. *The frame of an Obsidian arrow (8,500 BC)*

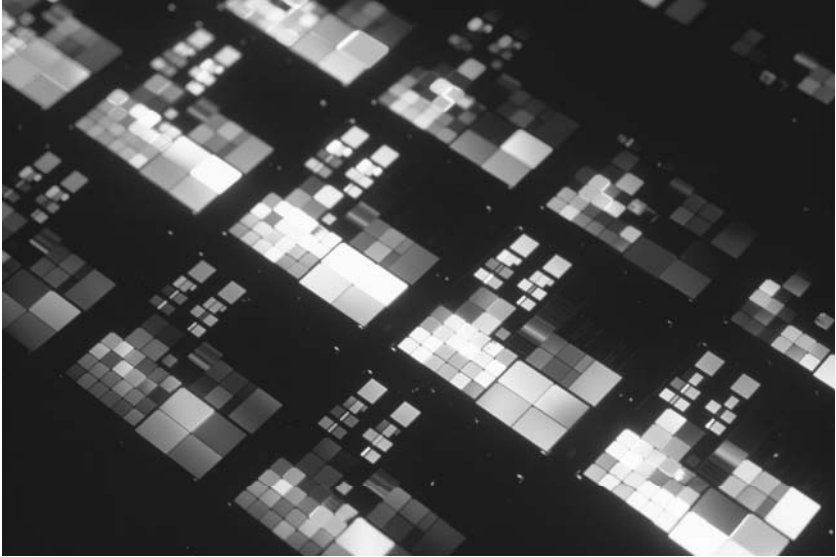

Figure 7.7. *A silicon plate used as a mask for nanoprining*

Different shapes have been carved into this mask. These shapes are differentiated by color. It first serves as a mask and then is reproduced by being pressed into resin. This process allows the rapid reproduction of electronic chips by the process of nanoprining.

7.2.3. Understanding information

There was a 5,000 year gap between the *Epic of Gilgamesh*, the first book printed on clay plates, and the Internet and a 550 year gap between the invention of movable type printing by Johann Gutenberg and today's electronic libraries.

The silicon revolution, essential for data processing, dates back 50 years. This is the leading field in the evolution of top-down technology, a seemingly endless process of miniaturization whose innovations transform our lifestyle.

Whether it concerns the press, radio, telephones, terrestrial channels or the Internet, the evolution of information systems is steadily growing.



Figure 7.8. *Epic of Gilgamesh (engraved on clay)*

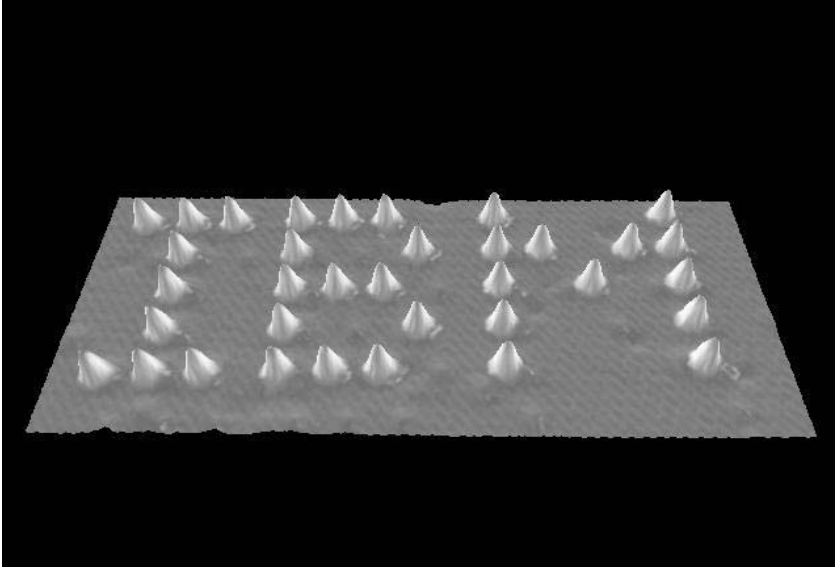

Figure 7.9. *The Beginning*, written by an atomic force microscope (xenon on nickel)

7.2.4. Understanding life

For millennia, humankind has domesticated animals and bred the most useful ones (cows, sheep, horses, etc.), worked the land to humanity's benefit and thereby invented agriculture. Farming culture has acquired a wide practical knowledge which has led to better harvests, particularly due to improvements in plowing techniques. It is in this way that the staple foods of wheat, rice, corn and potatoes were able to sustain rapidly growing populations that followed progress made in hygiene and diet. Machinery, fertilizers and enhanced agricultural methods currently allow six billion people to live and thrive on this planet.

Mendel's Laws, which mark the beginning of genetics, date back 150 years, whereas molecular biology dates back only 50 years. With the discovery of the genetic code, from which all

organisms originate, we potentially have control over life itself. It is the quintessential domain of bottom-up science. The observation and analysis of the molecular world allows us to understand, and moreover to have an effect on, the functions of nanomachines with their fascinating properties.



Figure 7.10. *Gregor Mendel (1822–84), the father of genetics*

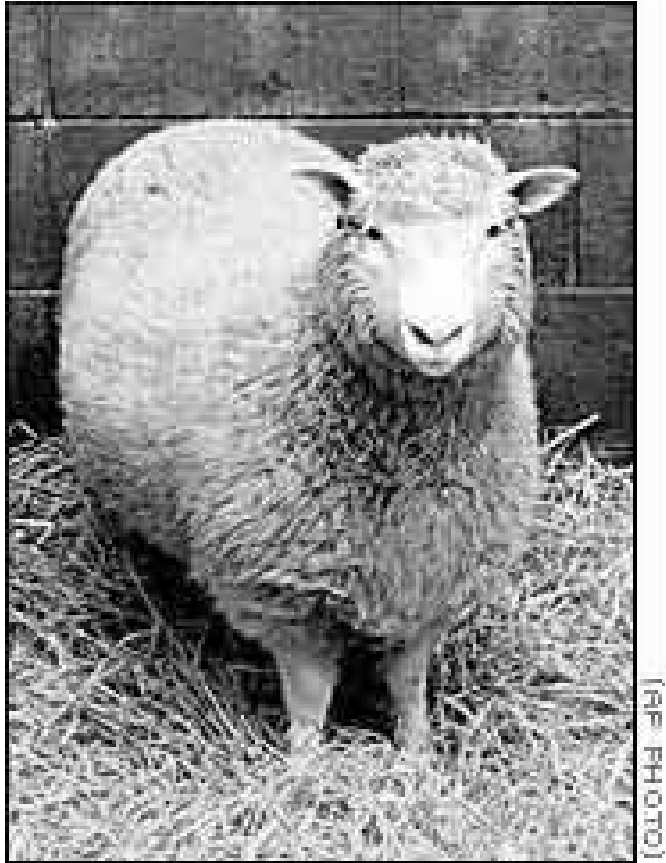

Figure 7.11. *The first clone, Dolly the sheep (1996)*

Within the four previously mentioned domains, our ever-growing knowledge has spawned significant developments dating back several decades. This knowledge, which leads to the emergence of nanosciences and nanotechnologies, represents a very important step in human evolution.

7.3. Watch out for nanomedicine

Nanotechnology has recently made an appearance in the field of health care. The two sectors which are particularly concerned by this have more or less advanced industrial applications.

The first of these sectors brings together the worlds of microelectronics and molecular biology for diagnostic procedures and for the production of drugs. In order to do this, varying hybrids of lab-on-a-chip (LOC) are used. This is illustrated by a DNA chip and in the near future it will be illustrated by a protein chip. This type of technology combines microfluidic and surface functionalization, which in turn allows increased reliability, precision, and finally a higher speed in screening (tests carried out on large quantities of samples). The market is impressive considering the benefits to be gained by players in the pharmaceutical industry.

The second sector combines new biological materials giving rise on the one hand to the production of new machines for use in medical imagery and on the other hand vectors that enable certain drugs to be more effective. The aim is to be able to operate at the level of the cell. This means that we are entering the experimental and futuristic world of nanorobots. However, the acceptance of nanomedicine may not be straightforward and there is a possibility that these objects may be rejected.

nanomedical destrobot; a nanotechnological object capable of 'search and destroy' functions for the elimination of harmful or diseased cellular organisms

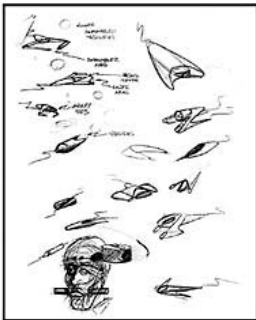
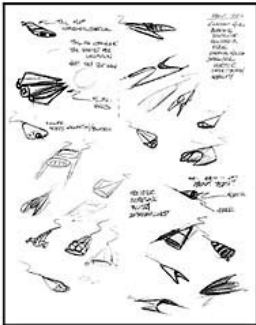
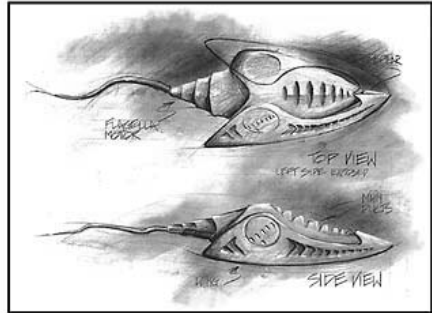

Figure 7.12. A fictitious bionanorobot

7.4. Nanosciences and our future

We have seen that the nanoworld is above all a place where all of our scientific knowledge and technological innovations meet. All functions of the nanoworld make up our world and consequently a multidisciplinary approach is required. It brings together domains which were at one point separate and merges the know-how and techniques of each. It could possibly give rise to a new paradigm and alter our relationship with the world around us.

Humankind's innate desire to continually develop more relationships and networks mirrors the evolution of the brain which is shaped by electric impulses and synaptic connections.

The understanding of the nanoworld increases our knowledge of the previously unknown, but at the same time raises concerns.

The use of new materials, in particular microfibers, could carry risks as was the case with asbestos. We are familiar with the dangers of allergy-causing dust or cancer-causing molecules, such as those emitted by diesel engines. Problems also arise with products that have nanostructures within them, both on the production level and their subsequent usage. This takes us back to the general issue of new artificial molecules whose long term effects on organisms are not yet known, especially when weak doses are used. Carbon nanotubes fit into this category, even more so because they are used in so many domains, particularly in the field of pharmacology.

Certain aspects of nanosciences can lead to the perception that they are magical, but potentially very dangerous. Furthermore, this perception is often reinforced by the media who target the public's emotions rather than rational thinking. If nanosciences allow for rational predictions of economic development (road maps), then they also allow for pure fiction. "It's as if nanotechnologies had become the magic potion, the magical cure making any

phenomenon possible with the guarantee of a pseudo-scientific explanation.⁵” This fiction increases the fear of modern technology, and even the fear of new knowledge. We are now far removed from the 19th century and the world of Jules Verne, a century of positivism where science was to bring progress and happiness. We live in a world where disasters, such as mad cow disease, Chernobyl, Seveso, Hiroshima and Nagasaki, all sparked off by human technology, changed the face of science and debates on genetically modified organisms did nothing to improve the public’s image of science. However, we have never before needed so much help from science to resolve future challenges. Finding solutions for health, energy, security and the protection of our ecosystems is only possible through our intelligence and understanding of science.

Is this a dream or a nightmare? Is the perceived rise in risks we have to take in order to acquire knowledge real?

Why do some people demonize nanosciences? During the inauguration of Minatec in Grenoble on June 1, 2006, in the center of innovation in micro and nanotechnology CEA/Leti-INPG, a strong opposition to futuristic sciences of experimental nature, called “nécrosciences”, was very evident. These developments which call to mind images of Big Brother⁶ and *Frankenstein*⁷ intensify the doubts about scientific progress and in particular its application.

5 Michio Kaku, *Visions: How Will Science Revolutionize the 21st Century?*, 1999, Albin Michel, p. 364.

6 Big Brother is a fictitious character created by the British novelist George Orwell for his novel *1984*. It has since become the symbol of the police state.

7 *Frankenstein*. A science fiction novel written in 1818 by Mary Shelley.

In 1989 Roland Fivaz, Professor at the Swiss Federal Institute of Technology in Lausanne wrote:

A concrete example of crossing networks is happening right in front of us: it is the great revival of all sciences which depend on information technology. Through its own development, information technology has affected science in two main ways. On one hand, it restrains science by introducing general standards of formalization, speed and precision, and on the other hand it enhances them by taking these three aspects beyond their traditional limits ... Furthermore, information technology allows the most sophisticated control over the movement of people and things ... Even in the technological domain, the blending of different technologies is an immense task which is also chaotic at times, as seen with the invasion of microprocessors. What is more disturbing, this technological race has given rise to gadgets of little importance as well as extremely powerful weapons. No one will know what to make of all this frenzy in 10 years ...⁸.

It is clear that scientific knowledge can lead to anxiety because of the conceptual changes it brings to our representation of the world. However, the temptation to refuse any new technological advances is as much a disillusion as the desire to stop time or even to travel back in time.

It must be noted that disasters occurred long before scientific progress; for example massacres, exploitation of natural resources and of human beings have existed since the beginning of humanity. It is not the weapon that wages war, but those that create and develop it, as illustrated in the Roman proverb: *Si vis pacem, para bellum* (If you want peace, prepare for war).

The control exerted over populations by dictatorships existed well before the development of computers and biometric passports. The only thing silicon has done is to replace clay tablets, whereas the administrative process remains the same.

⁸ "Where will information technology take us?" in *L'Ordre et la Volupté*, Presses Polytechniques Romandes, 1989, p. 126.

Furthermore, certain recent disasters are not due to knowledge and technological development, but rather that of deliberate ignorance for financial reasons. Some examples include the contamination of blood even though a virus had already been identified, and the spread of mad cow disease due to the contamination of low-cost feed. Such disasters can also stem from the non-application of security measures; for example Chernobyl, AZF (explosion at a Toulouse chemical factory), and the use of asbestos without relevant protection for those in contact with it despite the well-documented dangers. Finally, they can be due to a lack of political power, which is illustrated by the fact that the polluting people are rarely those who suffer from their actions. We are aware of the causes of pollution, but we continue to pollute anyway; we consume more than we need to; we waste our resources although we are aware of their limits; and we live as if we were immortal. Blaming nanos becomes an alibi for defending an ideology as was the case with the disastrous communication on genetically modified organisms – this famous nanomedicine.

We must remember that science does not aim to create happiness, but it can contribute to it. We now have a better standard of life and live longer, although this is certainly not the case everywhere. Never before has there been such a large number of people on the planet and this explains the great need for intelligence in order to overcome the challenges that our evolution poses.

Let us remain optimistic: the international conference “Nano for the Environment”, which took place in Stuttgart in October 2006, presented the positive effects of nanotechnologies on the environment:

... Nanoparticles in sunscreen protect from UV rays; nanolayers are used in anti-scratch spectacles; nanoparticles in paint protect the material from mold and fungus. The environment also benefits from nanotechnology because it means that less material is used for the same task which leads

to a better protection of our resources. Nanotechnologies result in better energy efficiency of products, lower emissions, as well as new filtering possibilities of air, water, and soil pollutants⁹.

7.5. Essential ethics

Nanosciences, and the nanotechnologies that they create, cannot escape the double-edged sword of progress and the consequent risks that always exist.

The development of micro and now nanoelectronics has led to a multitude of innovations and products that will change our way of life. Some people worry about the protection of our fundamental rights if the applications of nanoelectronics are not regulated.

Video surveillance systems, which were originally put into place for security reasons, could be used for other ends, especially in the case of ultraminiaturized versions. Chip cards, such as ID cards and health insurance cards, contain more and more information and can be read from a distance; therefore confidentiality must be guaranteed. Personal files and information therefore require a high level of security. In France, the CNIL (Commission Nationale de l'Informatique et des Libertés) is responsible for the protection of personal information.¹⁰

9 This information is an extract from *BE Allemagne*, no. 305, October 5, 2006, written by the French embassy in Germany. The *Bulletins Electroniques* (BE) are a subsidiary of ADIT and are available from <http://www.bulletins-electroniques.com>.

10 An independent French administrative authority whose mission is to ensure that data privacy laws are applied to the collection, storage and use of personal data. <http://www.cnil.fr>.

The Internet has allowed the general public to access information from all domains. Dangerous networks such as those of terrorism and pedophilia also make use of the Internet. A new type of criminality has emerged, which either seeks to disrupt operations (virus creators) or consists of stealing information from databases (hacking, industrial espionage) to reroute confidential information. This is particularly commonplace in the world of e-commerce which demands the transfer of bank details. This is far from new, but the scope has radically increased. The Internet has become a major tool in economic warfare.

Sailors no longer go out to sea without their global positioning system (GPS), which gives their position to the nearest meter. They also appreciate Argos, a satellite-based system for environmental data collection, which can save their life. With cell phones you can always be located. Some systems even allow the surveillance of children going to school or that of criminals released on probation.

Anything is possible, but be careful because errors are common.

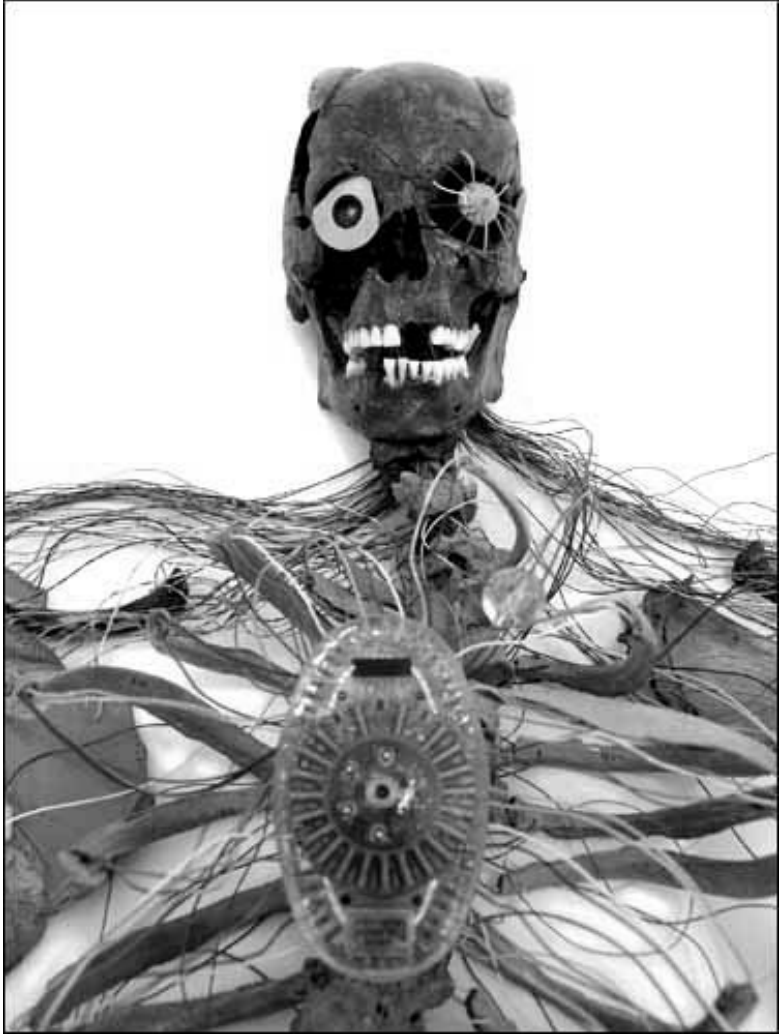

Figure 7.13. *A detailed relic of the bionic man*

Nanosciences and nanotechnologies have led to new possibilities in the most sensitive of all domains which is life itself.

The concept of life is unique as is each individual life¹¹.

The comparisons between the human genome and those of other species enable researchers to identify genetic elements conserved during evolution. Certain genes have remained unchanged and are common to all species, which confirms without a shadow of a doubt the uniqueness of life.

There is little difference between the genomes of closely related animals. The difference between the genome of a mouse and the genome of a human is approximately 600 genes. The genome differences between people are for all intents and purposes insignificant.

The extinction of a species corresponds to a lost and unsalvageable genome. Humankind is at the origin of the sixth crisis¹² that affected our planet. This is perhaps the most significant since more than 15,000 species faced extinction, including one in every four mammals.

Knowledge of certain biological mechanisms and technological advances in the area of genetic manipulation gives humankind an exceptional level of responsibility. This knowledge applied to health care will enable the prevention or cure of many kinds of diseases. We can, in certain cases where there is a risk of hereditary genetic diseases, select and implant an embryo which does not carry the deficient gene. By doing so we are approaching eugenic practices.

11 No other trace of life has so far been detected in the Universe.

12 The last crisis saw the extinction of dinosaurs 65 million years ago.

A French committee, the National Consultative Ethics Committee for Health and Life Sciences (CCNE)¹³, was created in 1994 with the remit of pronouncing on ethical issues relating to applications and developments in technosciences. The CNRS also created an ethics committee, which in 2006 published recommendations on nanotechnologies (see Appendix B). Other countries, such as the UK and the USA¹⁴, have also introduced similar committees.

It is also useful to remember that all knowledge and all man-made creations can also serve military purposes. Intelligent weaponry is of course more subtle than the thermonuclear bomb, but it is just as dangerous to man.

7.6. Conclusion

The Universe is 10 billion years old and for several years out of these 10 billion we have been developing nanosciences. Now it is time for nanosciences.

The Big Bang started everything.

In the beginning, there was a void filled with an enormous energy. Quarks, which burst forth from this explosion, joined together to form protons and neutrons, which in turn generated the atomic nuclei of a universe in expansion. As soon as the drop in temperature permitted, the first atoms appeared in space, then the first molecules, giving rise to gas, liquids, solids, and eventually planets when the conditions were appropriate.

13 <http://www.ccne-ethique.fr>.

14 <http://www.nanoethics.org>.

The creation of the solar system as we now know it took place and life appeared, at least on one planet – Earth. The ecosystems and species of animals evolved according to the laws of natural selection. Amongst mammals, our ancestors the hominoids first appeared a few million years ago. The particularly complex cerebral make-up of man allowed him to understand his environment rationally and then to accumulate the knowledge needed to create and give birth to science as it is understood today. In ancient Greece, Democritus spoke of atoms and the granular nature of light, which was treated by Pascal in the 17th century, but until the beginning of the 20th century the theories of thermodynamics, mechanics, and electromagnetism provided us with our vision of the continuous world. Technologies were represented in human dimensions, for example by the meter. We developed investigation on the existence of the infinitely large (the first object of observation for man was the sky), but the infinitesimal remained unknown.

The understanding of new phenomena in our world was essential to enable us to transfer knowledge and technology to the nanoworld. This is similar to a reversed Big Bang, bringing different branches of science together. Nanosciences lead us to a better understanding of ourselves, whereas the unification of force-related theories rules our world.

But where will it end?

The biologist in Wonderland

Researchers dressed in white coats, equipped with safety goggles and gloves with sensors, launch themselves into space. They seem to create and make use of imaginary objects to simulate the construction of unknown edifices. This is reminiscent of the child's game where the objective is to guess the name of an object from someone's gestures. Or maybe it would be one of those "progressive" dances with a psychedelic background full of spheres, spirals and colored filaments?

This is not a theatre hall, but an advanced biotechnology research laboratory. It is difficult to understand the scientific processes involved if you do not look through the microscope when choosing a molecule and bonding it with an active virus with the vision of improving the quality of research for new medication. The researcher analyzes and classifies a new molecule, whereas the computer holds the data, calculates the interactions, and guides the researcher. The researcher now becomes an actor in the virtual world.

This modern version of traveling into the infinitesimal is contrary to the outdated idea of science fiction which consisted of traveling within the human body by miniaturizing ourselves. Nowadays, the molecules have become life size and we are able to control their makeup and how they are linked to other molecules; this then allows us to regulate their modes of communication¹⁵.

15 Hardly a futuristic description. On the one hand, researchers have been working on this principle for several years on 3-D screens; on the other hand, numerous IT and image processing laboratories are affected by advanced research on the manipulation of virtual objects in space.

This page intentionally left blank

Appendices

This page intentionally left blank

Appendix A

European Parliament Resolution on Nanosciences and Nanotechnologies: An Action Plan for Europe 2005–2009

The European Parliament

– having regard to the Commission Communication of 7 June 2005 entitled Nanosciences and nanotechnologies: An action plan for Europe 2005–2009 (COM(2005)0243),

– having regard to the joint report by the Royal Society and the Royal Academy of Engineering of 29 July 2004 entitled Nanoscience and nanotechnologies: opportunities and uncertainties,

– having regard to the Presidency Conclusions of the Brussels Competitiveness Council of 24 September 2004,

– having regard to the opinion of the European Economic and Social Committee on the Commission Communication: Towards a European strategy for nanotechnology and its opinion regarding the above-mentioned Commission Communication of 7 June 2005,

– having regard to Rule 45 of its Rules of Procedure,

– having regard to the report of the Committee on Industry, Research and Energy and the opinions of the Committee on the Environment, Public Health and Food Safety and the Committee on Legal Affairs (A6-0216/2006),

A. whereas the Commission has adopted an Action Plan for the immediate implementation of a safe, integrated and responsible strategy for nanosciences and nanotechnologies,

B. whereas nanosciences and nanotechnologies have the potential – as multidisciplinary sectors – to benefit society hugely by the development of new products, materials, applications and services, thereby raising productivity and the quality of life in the EU as a whole,

C. whereas the Council recognises the important role of nanotechnologies in many areas and stresses the importance of continuing to generate scientific and technological knowledge in this area and of encouraging its use in industrial applications,

D. whereas the European Economic and Social Committee believes nanotechnologies could greatly help the EU to achieve the objectives set by the Lisbon Strategy,

1. Welcomes the above-mentioned Commission Action Plan, which defines a series of concrete and interconnected actions for the immediate implementation of nanosciences and nanotechnologies, based on priority areas determined according to future needs;

2. Recognises the important role that nanosciences and nanotechnologies can play as breakthrough technologies in stimulating the achievement of the economic, social and environmental goals of the EU; acknowledges the fact that nanotechnologies can address the needs of citizens (public health,

energy, transport, sustainable development, etc.), as well as contribute to the EU's competitiveness and sustainable development objectives;

3. Notes that technology platforms, expert advisory groups, and action plans are useful instruments for helping to develop commonly agreed research agendas and deployment strategies in the field of nanotechnologies and nanosciences, thereby creating new jobs and enhancing economic growth;

4. Supports the objectives and initiatives set out in the above-mentioned Commission Communication of 7 June 2005; welcomes the clear focus in that Communication and in the above-mentioned Action Plan;

5. At the same time, stresses the need to increase publicly funded investment in R&D; realises that the fragmentary nature of the European research landscape reflects the easy availability and relatively low cost of nanoscience research, but is also aware that funds need to be set aside for the establishment and maintenance of the necessary large-scale facilities, including, in particular, clean rooms, lithographic processes and very costly analytical procedures; in this regard, expresses its concern at the current level of European public investment in nanosciences and nanotechnologies, recommends that the ambitions set out in the above-mentioned Action Plan be appropriately matched in financial terms and supports the Commission's readiness to very substantially increase the resources devoted to research in this field, which is of fundamental importance to Europe's future development;

6. Considers that Europe needs a coherent system of world-class R&D infrastructure in order for the EU to remain competitive in the field of nanosciences and nanotechnologies; draws attention to the fact that, in order to enjoy possible economies of scale, and owing to its interdisciplinary and complex nature, the infrastructure for R&D in nanotechnologies calls for a critical mass of resources

that are beyond the means of local governments and industry; recognises, on the other hand, that smaller-scale national R&D policies may often be in a better position to react adequately to changing opportunities and market developments; therefore, urges the Commission and the Member States to reinforce and co-ordinate their R&D efforts in this field; to this end, recommends, in each Member State and in accordance with each country's characteristics, the creation of a minimum critical mass of infrastructure and scientists with specific expertise in nanosciences and nanotechnologies, leading ultimately to the creation of specialised centres of excellence in some countries which would be co-ordinated at EU level;

7. Draws particular attention to nanomedicine as a promising interdisciplinary domain with breakthrough technologies such as molecular imaging and diagnostics, which can offer impressive benefits for the early diagnosis and smart and cost-effective treatment of diseases such as cancer, cardiovascular problems, diabetes, Alzheimer's and Parkinson's; urges the Commission and national and regional authorities to boost their R&D investments in this domain and to co-ordinate their efforts by means of the Nanomedicine European Technology Platform proposed in the Seventh Framework Programme for research, technological development and demonstration activities (Seventh Framework Programme), and by means of other instruments, including the Regions of Knowledge proposed in the Seventh Framework Programme, so as to achieve critical mass in this field;

8. Stresses the major role to be played by nanosciences and nanotechnologies in developing molecular biology;

9. Is convinced that multidisciplinary nanosciences and nanotechnologies should be geared to the development of hydrogen energy, including the development of new and effective means of storing hydrogen and efficient fuel cells, as well as information-carrying technologies with much greater capacity than at present;

10. Stresses the considerable progress made in Europe in the field of nanotechnologies, based on a top-down approach, particularly in areas such as nanocomposites, abrasion- and corrosion-proof coatings and layers, and also the production of catalysers and photodiodes, including the so-called blue laser, as well as in the field of nanomedicine, nanocosmetics and nanodiagnosis of diseases;

11. Believes that the level of basic European research can make it possible to find technological tools that will enable a bottom-up approach to be adopted, particularly in nanoelectronics;

12. Believes that actions to accelerate technology development must be complemented by policy measures to ensure the market penetration of existing technologies; notes that standards can provide a level playing field for markets and international trade and are prerequisites for fair competition, comparative risk assessments and regulatory measures; calls therefore on the Commission and the Council to remove any barriers in the form of absent standards or unclear legislation, which unnecessarily hold back the adoption of nanotechnologies and nanosciences in Europe, and to do so without imposing any new bureaucratic hurdles;

13. Stresses the importance of generating the “triangle of knowledge” (ie education, research and innovation) needed for the European Research Area; considers that in order to achieve the necessary synergy between research, education and innovation, a comprehensive knowledge transfer approach, and also the development of cross-sector human resources, are needed; calls therefore on Member States to develop strategies to improve knowledge transfer and to address the skills shortage by increased emphasis on natural science training and by attracting more students into nanoscience and science-related, multidisciplinary subjects; welcomes the Commission’s effort to support research training networks in nanotechnologies and calls on the Member States to create, both in isolation and in close co-operation with

each other, multidisciplinary networks to combine nanotechnologies with a broad spectrum of research areas, with the aim of developing new hybrid technologies;

14. Considers that industry, research institutes and financial institutions should work together to ensure that excellent R&D in nanosciences and nanotechnologies is translated into new products and processes; believes that Member States should accelerate and stimulate this process by focussing on improving the business climate for companies in the nanotechnology sector in their country, especially start ups, SMEs and innovative companies; considers, in this regard, that the protection of intellectual property rights is essential for innovation, in terms both of attracting initial investment and of ensuring future revenue; calls on the Commission to develop standards for the protection of intellectual property rights and models for licensing agreements;

15. Regrets the fact that the patenting of nanoscience and nanotechnology inventions in Europe is developing slowly; calls on the EU to create a nanoscience and nanotechnology patent monitoring system governed by the European Patent Office;

16. Encourages general reforms in the field of the European patent system in order to cut the costs of patenting and to improve accessibility to patents for SMEs; stresses the need for greater transparency and clear limits to the scope of patent protection;

17. Is convinced that Europe's chances of being and staying at the forefront in this field hinge upon its capacity for co-ordination; reiterates the need for a single Community focal point for co-ordination and the importance of the EU speaking with one voice on the international stage, particularly in the light of the challenges presented by patent protection in China; calls therefore on the Commission and Members States to devise mechanisms to effectively co-ordinate actions in this field; urges the Commission to take into account in its policy making all activities within the

OECD (eg definitions, nomenclature, risk management) and UNESCO (ethics);

18. Recognises that an essential element of a responsible strategy is the integration of social, health and safety aspects into the technological development of nanosciences and nanotechnologies; in this regard, urges the Commission, the Member States and European industry to engage in an effective dialogue with all stakeholders, so as to steer developments along a sustainable path;

19. Stresses that the technological risks posed (from conception to disposal or recycling) to human health, consumers, workers and the environment must be assessed throughout the life cycle of nanoscience and nanotechnology products;

20. Recommends that lists of ingredients in consumer products identify the addition of manufactured nanoparticulate material;

21. Emphasises the need to respect high ethical principles and welcomes the planned reviews on issues such as non-therapeutic human enhancement and links between nanosciences and nanotechnologies and individual privacy; expects the reviews to be public and to include a thorough analysis of nanomedicine;

22. Supports the setting up of ethical committees which, by providing independent scientific advice, will help ensure that the public is properly informed and help create a climate of trust based on awareness of the possible risks and benefits associated with the use of discoveries in the field of nanotechnologies;

23. Welcomes the consultation conducted for this proposal and encourages the Commission to continue improving its work in order to respond to the increasing demand for better regulation;

24. Welcomes the intention of the Commission to develop appropriate multilingual information material for different age groups in order to raise awareness of the progress and expected benefits of nanosciences and nanotechnologies; encourages the Commission to do so in close collaboration with Member States; urges the Commission to devise a communications strategy to raise the public's awareness of the enormous opportunities offered by nanotechnology, and to allay their fears; considers that, as part of this communications strategy, the Commission should also make use of ideas such as a roadshow (featuring a "Nanoscience Truck") or a nanotechnology award;

25. Calls on industry to share in the joint effort and urges it to participate in developing nanotechnologies, taking into account their wider economic, societal, health, safety and environmental effects and acting in accordance with the principles of corporate social responsibility; in this regard, stresses that businesses should help disseminate objective information about scientific discoveries in the nanoscience and nanotechnologies field, about their intended uses, their risks and benefits for society;

26. Emphasises that all applications and uses of nanosciences and nanotechnologies must comply with the high level of protection of human health, consumers, workers and the environment prescribed by the EU and insists on the need for the codification of nanomaterials, which lead to the drawing up of standards, which would in turn boost efforts to identify any risks; calls on the Commission to take the necessary initiatives to this end;

27. Emphasises the importance of the miniaturisation of products with regard to helping reduce waste and ensuring better use of energy;

28. Emphasises that understanding of the potential damage to health and the environment of new, synthetic nanoparticles is still limited and that, consequently, the effects of nanoparticles that are not readily soluble or biodegradable should be investigated, in accordance with the precautionary principle, before such particles are put into production and placed on the market;

29. Calls on the Commission to pay special attention to the development of nanosciences and nanotechnologies in the new Member States, by providing them with the means to define research profiles of their own, while at the same time further enhancing the cutting-edge position of the main European locations with a view to creating a leading global role for Europe;

30. Stresses the importance of international co-operation in the field of nanosciences and nanotechnologies; calls on the Commission to intensify further the already excellent relations with Russian scientists in particular and to investigate the possibilities and limitations of co-operation in this area with the USA, Japan, China and India; calls on the Commission to enhance international co-operation with a view to harmonising nanoscience and nanotechnology patent application processing between the EU, the USA and Japan; stresses that dialogue should be intensified in compliance with the WTO obligations;

31. Instructs its President to forward this resolution to the Council and Commission, and to the governments and parliaments of the Member States.

This page intentionally left blank

Appendix B

Eight Guidelines on Nanotechnologies Issued by the CNRS Ethics Committee

Paris, 16th October 2006

The CNRS Ethics Committee (COMETS) published its assessment of the ethical challenges set by nanotechnologies and nanosciences. It offers advice and eight guidelines to the CNRS as an institution, its researchers and its partners. The Committee's assessment is published at a moment in time when the rapid development of science on an atomic level is fascinating scientists and is worrying the public. The guidelines were published a few days before the interministerial think tank on the challenges and risks of nanotechnologies and nanomaterials.

Nanosciences because of their great potential in important discoveries, and nanotechnologies due to their possible combination with other technologies such as bio-, information and cognitive technologies, might lead to developments that need to be examined on an ethical level. The social impact they may bring about can neither be ignored by scientists involved in its research nor by companies which promote nanosciences and nanotechnologies. The multidisciplinary character of the CNRS

makes it an institution privileged to fostering reflection and discussion on the subject of nanosciences, a subject which is currently at the center of public attention. A number of decision-making bodies have recently claimed the need for a responsible development of nanotechnologies. With its eight guidelines, the COMETS would therefore like to enlighten the current state of nanosciences and nanotechnologies for researchers as well as for the CNRS as an institution. The objective of these eight guidelines lies therefore in finding a balance between freedom of scientific research and responsibility towards society.

Overall, the objective of the COMET's guidelines is to develop an ethical form of research through a series of norms and regulations, which in practice will not hinder funding and positive results of research. Finally, these guidelines will encourage a constant consideration of ethics combined with measures that should encourage further reflection on the values and aims of scientific research.

The final goal is to bring about a profound change in mentality in the area of research where ignorance or even the complete refusal of ethics can often be observed. This change requires scientific researchers of all disciplines to have an awareness of ethical reflections on science and their technical application. The presence of ethics in science can no longer be perceived as a service which is delivered by specialists in the field over a short time span. This change in mentalities will take time and measures which are strong enough to support the presence of ethics in science in the long term. In accordance with its mission, the Ethical Committee would like to observe and actively support this process.

The publication of the assessment of ethical challenges in nanosciences and nanotechnologies is pursued by three major events. On 19th October COMETS will attend the interministerial think tank on challenges and risks linked to nanotechnologies and nanomaterials organized by high ranking civil servants of the Ministry for Health. Furthermore, the spokesperson of COMETS

think tank, who wrote the assessment, will be heard in front of the French National Assembly by the OPECST (French parliamentary office for scientific and technological decision-making). Last, but not least, in March 2007, COMETS organized a conference on nanosciences and nanotechnologies for the employees of the CNRS. COMETS also maintains an intensive exchange with the National Consultative Ethics Committee for Health and Life Sciences (CCNE) on the subject of nanosciences and nanotechnologies. The latter is currently preparing a report on the nanoworld in the field of science.

COMETS is an advisory body which consist of 12 members, all of them engineers or researchers of various disciplines within the framework of the CNRS's administrative council. Created in 1994, COMETS reflects on ethical issues raised by progress made in research. The ethical committee issues guidelines and creates awareness among the CNRS's employees. Its current chairman is the astrophysicist Pierre Léna.

The eight guidelines issued by the COMETS

1. In order to increase dialogue, COMETS encourages the participation of scientists in pressure group meetings, such as industrialists, consumer associations, associations for people affected by diseases, non-governmental organizations, etc., which are interested in the development of research programs. Scientists' assessments of nanosciences and nanotechnologies are essential for decision-making bodies, as they need to be able to understand the implications for society. Because of its multidisciplinary character and its preoccupation with the application of new techniques, the CNRS needs to be the driving force of this dialogue.

2. Introduce awareness of ethical issues in the field of research at different stages of the researcher's career. This should start during education, be present in evaluation processes, as well as in the description of research projects.

3. Produce small guidebooks, or dossiers on ethics, which summarize the results of multiple studies using a register of language that can be easily understood.

4. Create ethical working spaces in research centers. In here, researchers, engineers and technicians could exchange their ideas with colleagues working in the fields of social sciences and humanities.

5. Increase the interest of researchers working in humanities and social sciences in the domain of nanosciences and nanotechnologies.

6a. Introduce procedures that will allow mediation in conflicts of interest between researchers and the private sector.

6b. Ensure transparency of funding and, if possible, the relevant project's results for all projects shared between the CNRS and the private sector.

7. Public relations:

– Present the expected advantages of nanosciences and nanotechnologies without hiding possible risks.

– Focus on the impact research in this field might have on human beings as well as the challenges linked to choosing nanosciences as a scientific priority. If possible, this should not only be limited to economic and industrial challenges.

– Take long-term challenges into account. This will help to identify the benefits and risks nanosciences might bring about.

8. Introduce or participate in debates with citizens on a local, national, European and international level.

The assessment of the challenges of nanosciences and nanotechnologies can also be found online: <http://www.cnrs.fr/fr/presentation/ethique/comets/index.htm> © CNRS.

This page intentionally left blank

Abbreviations

ADIT	Agence pour la diffusion de l'information technologique (French agency for the diffusion of technological information)
ATP	Adenosine triphosphate
CAD	Computer-Aided Design
CCNE	National Consultative Ethics Committee for Health and Life Sciences
CEA	Commissariat à l'énergie atomique (French national establishment for nuclear matters)
CERN	European Organization for Nuclear Research
CMOS	Complementary metal oxide semi-conductor
CNIL	Commission nationale de l'informatique et des libertés
CNRS	Centre national de la recherche scientifique (French public research organization)
DGA	Agency of the French Ministry of Defense
DNA	Deoxyribonucleic acid

fMRI	Functional magnetic resonance imaging
GMO	Genetically modified organism
GPS	Global positioning system
INIST	Institute for Scientific and Technical Information
LASER	Light amplification by stimulated emission of radiation
LED	Light-emitting diode
LETI	Laboratory for electronics and information technology (CEA)
LURE	Laboratory for the use of Electromagnetic Radiation
MEMS	Micro electro mechanical system
MOS	Metal oxide semi-conductor
MOSFET	Metal oxide semi-conductor field effect transistor
MRAM	Magnetic random access memory
MRI	Magnetic resonance imaging
mRNA	Messenger RNA
NASA	National aerospace administration
NIH	National Institutes of Health
NMR	Nuclear magnetic resonance
NOAA	National oceanic and atmospheric administration
OMNT	Observatory for Micro and Nanotechnologies

RFID	Radio frequency identification
RNA	Ribonucleic acid
SEM	Scanning electron microscope
STM	Scanning-tunneling microscope
TEM	Transmission electron microscope
UV	Ultraviolet

This page intentionally left blank

Bibliography

“La déferlante nano”, *Le Journal du CNRS*, no. 189, October 2005
<http://www2.cnrs.fr/presse/journal/2442.htm>.

“Les Nanosciences”, *Focus*, CNRS, November 2005.

Ministry for Research and New Technologies, *A la découverte du nanomonde*, 2005
<http://www.nanomicro.recherche.gouv.fr>.

“Le nanomonde, de la science aux applications”, *Clefs CEA*, no. 52, Summer 2005
<http://www.cea.fr/Fr/Publications/Clefs2.asp?id=52>.

PAUTRAT, JL, *Demain le nanomonde*, Fayard, 2002.

SERRES, M. and FAROUKI, N, *Le Trésor: dictionnaire des sciences*, Flammarion, Paris, 1997.

ADIT, in cooperation with the Ministry for Foreign Affairs,
International Observatory for Technology
<http://www.bulletins-electroniques.com>.

Observatory for Micro and Nanotechnologies (OMNT)
<http://www.omnt.fr>.

Wikipedia Encyclopedia
<http://fr.wikipedia.org/wiki>.

Figures

Figure 1.1. *Where can we find the nanoworld?*

Figure 1.2. *The scientific approach is advancing on all fronts*

Figure 1.3. *Two technological approaches to the nanoworld*

Figure 1.4. *Two key points: miniaturization and complexity*

Figure 2.1. *An effect of quantum physics: the tunneling effect*

Figure 2.2. *The electron, a universal actor*

Figure 2.3. *The photon, a super fast messenger*

Figure 2.4. *The electromagnetic spectrum*

Figure 2.5. *The photoelectric effect*

Figure 2.6. *Molecular orbitals and the band structure of crystalline silicon*

Figure 2.7. *Light-emitting diodes and lasers: general principles*

Figure 2.8. *Semi-conductor lasers*

Figure 2.9. *Quantum dot for single photon experiments*

Reprinted with permission from Anne Talneau (CNRS/Laboratory for Photonics and Nanostructures)

Figure 3.1. *The environmental scanning electron microscope*

Reprinted with permission from J.H. Lignot (ULP-CNRS)

Figure 3.2. *The principle of atomic microscopes*

Figure 3.3. *Functional magnetic resonance imaging (fMRI)*

Figure 3.4. *SOLEIL: a synchrotron in France. Diagram of a light line*

Reprinted with permission from public relation service of Synchrotron Soleil

Figure 3.5. *Fluorescence imaging*

Reprinted with permission from Alberto Bianco (Laboratory for Immunology and Therapeutical Chemistry, UPR 9021, CNRS, Strasbourg)

Figure 4.1. *Moore's Law*

Image produced by the author

Figure 4.2. *An example of a device for integrated circuits on silicon*

Reprinted with permission from STMicroelectronics

Figure 4.3. *View of a 300 mm clean room*

Reprinted with permission from STMicroelectronics, Crolles2

Figure 4.4. *On an atomic scale: the rules of the game are changing*

Poizat Jean-Philippe, Buisson Olivier, "Quand l'information devient quantique ...", *Nanotechnologies* (OMNT), October 2004, p. 30

Figure 4.5. *Plastic electronics has become a reality*

Firon Muriel, "Cellules solaires photovoltaïques organiques", *Microsources d'énergie* (OMNT), February 2005, p. 23
Reprinted with permission from Philips

Figure 4.6. *The MOS transistor*

Image produced by the author

Figure 4.7. *Photolithography*

Image produced by the author

Figure 5.1. *The cell, chromosomes and DNA*

Image produced by the author

Figure 5.2. *The path of complexity*

Image produced by the author

Figure 5.3. *The creation of a protein in ribosome*

Image produced by the author

Figure 6.1. *Carbon nanotubes*

Reprinted with permission from Alberto Bianco (Laboratory for Immunology and Therapeutical Chemistry, UPR 9021, CNRS, Strasbourg)

Figure 6.2. *An artist's view of the smallest nanotube transistor in the world*

Reprinted with permission from *Nano Letters* 5, 147, 2005
© 2006 American Chemical Society

Figure 6.3. *How carbon nanotubes work and the configuration of biosensors on a bed of coir-fibers*

Reprinted with permission from *Nano Letters* 4 (2), 191, 2003
© 2006 American Chemical Society

Figure 6.4. *A lotus leaf and the lotus effect*

Author's photo and © Photothèque CNRS, photographer: David Quere

Figure 6.5. *MEMS*

Figure 6.6. *A microgyrometer*

Exposition: “Zoom sur les micro et nanosystèmes”, CNRS, Paris, March 2005

Reprinted with permission from FEMTO-ST-EPFL

Figure 6.7. *Microlenses*

Reprinted with permission from Varioptic SA

Figure 6.8. *Engines*

Figure 6.9. *The motor molecules behind the intracellular network, carried out in vitro*

Patricia Bassereau, Aurélien Roux, “Formation et dynamique de nanotubes de membranes”, *Images de la physique*, CNRS, March 2005, p. 245

Reprinted with permission from the author and the director of the department CNRS/MIPPU

Figure 6.10. *Walking molecules*

Reprinted with permission from *J. Am. Chem. Soc.*, 126, 10834, 2004

© 2006 American Chemical Society

Figure 6.11. *An artificial dragonfly*

Journal du CNRS, no. 186, July-August 2005

Reprinted with permission from SilMach SA, Besançon, France

Figure 6.12. *The health care system*

Figure 6.13. *A global integration*

Figure 6.14. *Geronimo (Kersauson's yacht)*

Reprinted with permission from Rivacom

Figure 6.15. *A guided tour of a house in the future*

© Bruno Bourgeois for the CNRS

Figure 6.16. *Microfluid chips*

Reprinted with permission from CEA-LETI

Figure 7.1. *Virtual reality*

Figure 7.2. *The nuclear retinoic acid receptor*

Document Dino Moras, Institute of Genetics and Molecular and Cellular Biology

Figure 7.3. *A 3-D structure of the complex RXR-RAR function*

Document Dino Moras, Institute of Genetics and Molecular and Cellular Biology

Figure 7.4. *A steam engine constructed in 1928*

Reprinted with permission from Raymond Lemoine, manager of the site "Société française de Vierzon", France

Figure 7.5. *The magnetoplasma rocket VASIMR*

An artists view, doc. NASA

<http://www.planete-mars.com/news/2003/1208materiau.html>

Figure 7.6. *The frame of an Obsidian arrow (8,500 BC)*

© Photothèque CNRS, photographer: Magali Roux

Figure 7.7. *A silicon plate used as a mask for nanoprining*

© Photothèque CNRS, photographer: Emmanuel Perrin

Figure 7.8. *Epic of Gilgamesh (engraved on clay)*

Figure 7.9. *The Beginning, written by an atomic force microscope*

Reprint courtesy of International Business Machines Corporation

© 2006

Figure 7.10. *Gregor Mendel (1822–84), the father of genetics*

http://history.nih.gov/exhibits/nirenberg/popup_htm/01_mendel.htm

Figure 7.11. *The first clone, Dolly the sheep (1996)*

<http://archives.cnn.com/2001/WORLD/europe/UK/03/13/disease.dolly/story.dolly.ap.jpg>

Figure 7.12. *A fictitious bionanorobot*

<http://www.foresight.org/Nanomedicine/Gallery/Images/4.jpg>

Figure 7.13. *A detailed relic of the bionic man*

© Olivier Goulet

© ADAGP 2006

Some images taken from the Internet have been used without obtaining the necessary permission from the author. However, research was carried out to locate the author and contact was always attempted.

Index

A, B

Amino acid 96, 98
Atomic microscope 58, 59
Bioinformatics 6
Bottom-up approach 9, 10

C

Carbon atom 109
Chemical bonding 25
Complexity 11, 12 14
Computer 32, 36, 54, 72, 77, 78,
82, 83, 102, 141, 145
Computer-aided design (CAD) 102,
145, 147

D, E

DNA 93, 94, 95
Electromagnetic spectrum 29
Electron 22, 23
Electron microscope 55
Electronic microscope 19

G

Genetically Modified Organism
(GMO) 102, 103

L

Lab-on-chip (LOC) 159

M

Magnetic disk readheads 124
Magnetic resonance 60
Micro Electro Mechanical Systems
(MEMS) 13, 116, 120, 121
Mendel's laws 156-157
Microelectronics 3, 120, 159
Microlens 123
Micromotor 125-127
Microprocessor 3, 21, 41, 71, 77,
81, 82, 83, 84, 163
Miniaturization 11, 12, 14, 71
Molecular biology 67, 103, 156,
159

Molecular disfunctioning

Molecule 21, 25, 26, 34-36, 91, 93-101, 109, 147, 169, 171

Molecule 34

Moore's law 3, 73

mRNA 95, 98

N, O

Nanoobjects 110

Ohm's law 17

Optical microscope 53

P, Q

Photoelectric effect 31, 33

Photon 27, 28, 53

Polymers 4, 79, 117, 119, 135

Quantum physics 17-21, 30, 81, 82, 147

R

RNA 93, 95, 98

S

Scanning electron microscope (SEM) 56, 57

Scanning-tunneling microscope 19

Scientific approach 8

Self-assembly 34

Self-organization 12, 91

Semi-conductor 6, 7, 26, 37-38, 41, 44, 46, 72, 81, 84, 111

T

Technological approach 9, 10

Top-down approach 9, 10, 71

Transmission electron microscope (TEM) 55

V

Virtual reality 146